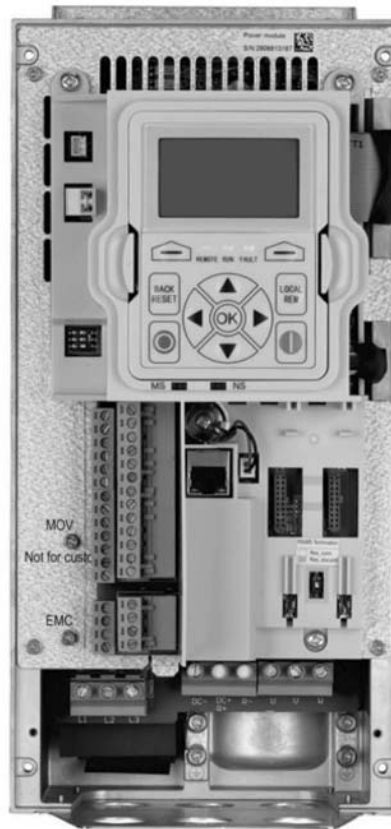


# Application manual



## **Disclaimer of warranties and limitation of liability**

The information, recommendations, descriptions, and safety notations in this document are based on Eaton's experience and judgment and may not cover all contingencies. If further information is required, an Eaton sales office should be consulted. Sale of the product shown in this literature is subject to the terms and conditions outlined in appropriate Eaton selling policies or other contractual agreement between Eaton and the purchaser.

THERE ARE NO UNDERSTANDINGS, AGREEMENTS, WARRANTIES, EXPRESSED OR IMPLIED, INCLUDING WARRANTIES OF FITNESS FOR A PARTICULAR PURPOSE OR MERCHANTABILITY, OTHER THAN THOSE SPECIFICALLY SET OUT IN ANY EXISTING CONTRACT BETWEEN THE PARTIES. ANY SUCH CONTRACT STATES THE ENTIRE OBLIGATION OF EATON. THE CONTENTS OF THIS DOCUMENT SHALL NOT BECOME PART OF OR MODIFY ANY CONTRACT BETWEEN THE PARTIES.

In no event will Eaton be responsible to the purchaser or user in contract, in tort (including negligence), strict liability, or otherwise for any special, indirect, incidental, or consequential damage or loss whatsoever, including but not limited to damage or loss of use of equipment, plant or power system, cost of capital, loss of power, additional expenses in the use of existing power facilities, or claims against the purchaser or user by its customers resulting from the use of the information, recommendations, and descriptions contained herein. The information contained in this manual is subject to change without notice.

Cover Photo: Eaton PowerXL<sup>®</sup> Series Drives

## **Support services**

### **Support services**

The goal of Eaton is to ensure your greatest possible satisfaction with the operation of our products. We are dedicated to providing fast, friendly, and accurate assistance. That is why we offer you so many ways to get the support you need. Whether it is by phone, fax, or email, you can access Eaton's support information 24 hours a day, seven days a week.

Our wide range of services is listed below.

You should contact your local distributor for product pricing, availability, ordering, expediting, and repairs.

### **Website**

Use the Eaton Website to find product information. You can also find information on local distributors or Eaton's sales offices.

### **Website address**

[www.eaton.com/drives](http://www.eaton.com/drives)

### **EatonCare customer support center**

Call the EatonCare Support Center if you need assistance with placing an order, stock availability or proof of shipment, expediting an existing order, emergency shipments, product price information, returns other than warranty returns, and information on local distributors or sales offices.

Voice: 877-ETN-CARE (386-2273) (8:00 a.m.–6:00 p.m. EST)  
After-Hours Emergency: 800-543-7038  
(6:00 p.m.–8:00 a.m. EST)

### **Drives technical resource center**

Voice: 877-ETN-CARE (386-2273) option 2, option 6  
(8:00 a.m.–5:00 p.m. Central Time U.S. [UTC –6])  
email: [TRCDrives@Eaton.com](mailto:TRCDrives@Eaton.com)

### **For customers in Europe, contact**

Phone: +49 (0) 228 6 02-3640  
Hotline: +49 (0) 180 5 223822  
email: [AfterSalesEGBonn@Eaton.com](mailto:AfterSalesEGBonn@Eaton.com)  
[www.eaton.com/moeller/aftersales](http://www.eaton.com/moeller/aftersales)

# Table of contents

<b>Safety</b>	
Before commencing the installation . . . . .	<b>xiii</b>
Definitions and symbols . . . . .	<b>xiv</b>
Hazardous high voltage . . . . .	<b>xiv</b>
Warnings and cautions . . . . .	<b>xiv</b>
Important safety information. . . . .	<b>xv</b>
<b>Chapter 1—PowerXL series overview</b>	
How to use this manual . . . . .	<b>1</b>
Receiving and inspection. . . . .	<b>1</b>
Real time clock battery activation . . . . .	<b>1</b>
Rating label . . . . .	<b>2</b>
Catalog number system . . . . .	<b>3</b>
Power ratings and product selection. . . . .	<b>4</b>
<b>Chapter 2—Keypad overview</b>	
Keypad buttons . . . . .	<b>9</b>
LED lights . . . . .	<b>12</b>
LCD display . . . . .	<b>12</b>
<b>Chapter 3—Menu overview</b>	
Main menu page . . . . .	<b>15</b>
Menu navigation . . . . .	<b>15</b>
Menu structure . . . . .	<b>16</b>
T—favorite . . . . .	<b>27</b>
<b>Chapter 4—Startup</b>	
Startup wizard page. . . . .	<b>28</b>
Startup wizard . . . . .	<b>29</b>
Application macro Mini-Wizard . . . . .	<b>30</b>
PID Mini-Wizard. . . . .	<b>30</b>
<b>Chapter 5—Standard application</b>	
Introduction . . . . .	<b>31</b>
I/O controls . . . . .	<b>31</b>
Force open/force close selection . . . . .	<b>32</b>
DIGIN selection . . . . .	<b>32</b>
Option board DIGIN selection . . . . .	<b>32</b>
Timer channel selection. . . . .	<b>32</b>
Control I/O configuration . . . . .	<b>33</b>
Standard application—parameters list. . . . .	<b>35</b>
Parameters . . . . .	<b>36</b>
Analog input . . . . .	<b>37</b>
Communication . . . . .	<b>49</b>
RS-485 Bus . . . . .	<b>51</b>
System. . . . .	<b>53</b>
<b>Chapter 6 — Multi-pump and fan control application</b>	
Introduction . . . . .	<b>56</b>
I/O controls . . . . .	<b>56</b>
Force open/force close selection . . . . .	<b>57</b>
DIGIN selection . . . . .	<b>57</b>
Option board DigIN selection . . . . .	<b>57</b>
Timer channel selection. . . . .	<b>57</b>
Control examples . . . . .	<b>57</b>
Control I/O configuration . . . . .	<b>66</b>
Pump and fan application—parameters list. . . . .	<b>68</b>

## Table of contents, continued

Parameters . . . . .	70
Analog input . . . . .	71
Bypass . . . . .	89
Pump parameters . . . . .	91
Multi-pump status . . . . .	91
Multi-pump measurement . . . . .	92
Communication . . . . .	97
RS-485 Bus . . . . .	99
System . . . . .	102
<b>Chapter 7—Multi-PID application</b>	
Introduction . . . . .	104
I/O controls . . . . .	104
Control I/O configuration . . . . .	106
Multi-PID application—parameters list . . . . .	108
Parameters . . . . .	110
Analog input . . . . .	111
Bypass . . . . .	132
Pump parameters . . . . .	133
Multi-pump status . . . . .	134
Multi-pump measurement . . . . .	135
Communication . . . . .	139
RS-485 bus . . . . .	142
System . . . . .	144
<b>Chapter 8 – Multi-purpose application</b>	
Introduction . . . . .	147
I/O controls . . . . .	149
Multi-purpose application—parameters list . . . . .	151
Parameters . . . . .	153
Analog input . . . . .	154
Bypass . . . . .	181
Pump parameters . . . . .	182
Multi-pump status . . . . .	182
Multi-pump measurement . . . . .	183
Communication . . . . .	187
RS-485 bus . . . . .	189
System . . . . .	192
<b>Appendix A – Description of parameters</b>	
Application level . . . . .	194
<b>Appendix B – Fault log</b>	
Fault codes and descriptions . . . . .	291
<b>Appendix C – PowerXL</b>	
Recommended secure hardening guidelines . . . . .	298

# List of figures

- Figure 1. RTC battery connection. . . . . **1**
- Figure 2. Rating label (samples). . . . . **2**
- Figure 3. Catalog numbering system. . . . . **3**
- Figure 4. Keypad and display. . . . . **9**
- Figure 5. General view of LCD. . . . . **12**
- Figure 6. Welcome page. . . . . **12**
- Figure 7. Upgrade page. . . . . **13**
- Figure 8. Auto backup page. . . . . **13**
- Figure 9. Main menu. . . . . **13**
- Figure 10. Parent node page. . . . . **13**
- Figure 11. Parameter page. . . . . **14**
- Figure 12. Parameter page from favorite menu. . . . . **14**
- Figure 13. Fault page. . . . . **14**
- Figure 14. Main Menu Page. . . . . **15**
- Figure 15. Main menu navigation. . . . . **15**
- Figure 16. M—Monitor. . . . . **17**
- Figure 17. Active faults. . . . . **18**
- Figure 18. Pop-up active faults. . . . . **19**
- Figure 19. Fault history. . . . . **20**
- Figure 20. Parameter menu overview. . . . . **21**
- Figure 21. Parameter sets. . . . . **22**
- Figure 22. Down from keypad. . . . . **23**
- Figure 23. Parameters comparison. . . . . **24**
- Figure 24. Password. . . . . **25**
- Figure 25. Edit parameter value. . . . . **26**
- Figure 26. Parameter locked. . . . . **27**
- Figure 27. Example of two-pump autochange, main diagram. . . . . **57**
- Figure 28. Two-pump autochange system principal control diagram. . . . . **58**
- Figure 29. Example of three-pump autochange, main diagram. . . . . **59**
- Figure 30. Three-pump autochange system principal control diagram. . . . . **59**
- Figure 31. Example of the function of the PFC application with three auxiliary drives. . . . . **60**
- Figure 32. Multi-pump control curve. . . . . **61**
- Figure 33. Multi-drive/multi-pump layout. . . . . **61**
- Figure 34. PowerXL drives with 10 V supply with a 0–10 V transducer. . . . . **62**
- Figure 35. PowerXL drives with 10 V supply with a 4–20 mA transducer. . . . . **63**
- Figure 36. PowerXL drives with ext. supply with a 4–20 mA transducer. . . . . **64**
- Figure 37. Bandwidth feedback. . . . . **65**
- Figure 38. Acceleration and deceleration time. . . . . **199**
- Figure 39. Motor parameters from ratings plate. . . . . **200**
- Figure 40. With and without reference scaling. . . . . **202**
- Figure 41. AI1 2 wire-current. . . . . **202**
- Figure 42. AI1 3 wire-current. . . . . **202**
- Figure 43. AI1 4 wire-current. . . . . **203**
- Figure 44. AI1 reference potentiometer 10 V. . . . . **203**
- Figure 45. Analog input AI scaling. . . . . **203**
- Figure 46. AI1 signal filtering. . . . . **204**

## List of figures, continued

Figure 47. AI1 no signal inversion. . . . .	204
Figure 48. AI1 signal inversion. . . . .	204
Figure 49. Example of joystick hysteresis. . . . .	205
Figure 50. Example of sleep limit function. . . . .	205
Figure 51. AI2 2 wire-current. . . . .	206
Figure 52. AI2 3 wire-current. . . . .	206
Figure 53. AI2 4 wire-current. . . . .	206
Figure 54. AI2 pot ref. . . . .	206
Figure 55. AI2 differential voltage. . . . .	207
Figure 56. AI2 filter time. . . . .	207
Figure 57. AI2 no signal inversion. . . . .	208
Figure 58. AI2 signal inversion. . . . .	208
Figure 59. Example of joystick hysteresis. . . . .	209
Figure 60. Example of sleep limit function. . . . .	209
Figure 61. Start forward/start reverse. . . . .	210
Figure 62. Start, stop, and reverse. . . . .	211
Figure 63. Start pulse/stop pulse. . . . .	212
Figure 64. Activation of fixed frequencies. . . . .	215
Figure 65. Start forward/start reverse. . . . .	221
Figure 66. Start, stop, and reverse. . . . .	222
Figure 67. Start, stop and reverse. . . . .	222
Figure 68. Analog output filtering. . . . .	225
Figure 69. Analog output scaling. . . . .	226
Figure 70. Analog output invert. . . . .	226
Figure 71. AO2 filter time. . . . .	227
Figure 72. Analog output scaling. . . . .	227
Figure 73. Analog output invert. . . . .	228
Figure 74. Supervision function. . . . .	230
Figure 75. Supervision function. . . . .	231
Figure 76. External brake control. . . . .	232
Figure 77. Acceleration/deceleration (S-shaped). . . . .	237
Figure 78. Acceleration/deceleration (S-shaped). . . . .	237
Figure 79. Example of skip frequency area setting. . . . .	238
Figure 80. Ramp speed scaling between skip frequencies. . . . .	239
Figure 81. Linear and squared change of motor voltage. . . . .	240
Figure 82. Programmable V/Hz curve. . . . .	241
Figure 83. Speed control F1. . . . .	243
Figure 84. Motor thermal current IT curve. . . . .	246
Figure 85. Stall characteristics settings. . . . .	247
Figure 86. Stall time count. . . . .	247
Figure 87. Setting of minimum load. . . . .	248
Figure 88. Underload time counter function. . . . .	249
Figure 89. Auto restart fail (try number >2.). . . . .	250
Figure 90. Setting up PID application. . . . .	257
Figure 91. DC-Braking time when stop mode = coasting. . . . .	264
Figure 92. DC-braking time when stop mode = ramp. . . . .	264

## List of tables

Table 1. Common abbreviations.....	1
Table 2. Type/IP20.....	4
Table 3. Type 1/IP21.....	4
Table 4. Type 12/IP54.....	4
Table 5. Type/IP20.....	5
Table 6. Type 1/IP21.....	5
Table 7. Type 12/IP54.....	6
Table 8. Type 0/IP00.....	6
Table 9. Type 1/IP21.....	7
Table 10. Type 12/IP54.....	7
Table 11. Type 0/IP00.....	8
Table 12. Keypad buttons.....	10
Table 13. LED state indicators.....	12
Table 14. Soft keys.....	13
Table 15. Keypad menus.....	16
Table 16. Startup wizard instructions.....	29
Table 17. Multi-Pump and fan control.....	30
Table 18. PID Mini-Wizard values.....	30
Table 19. I/O connection.....	33
Table 20. Drive communication ports.....	34
Table 21. Monitor—M.....	35
Table 22. Basic parameters—P1.....	36
Table 23. Basic setting—P2.1.....	37
Table 24. AI1 settings—P2.2.....	37
Table 25. AI2 settings—P2.3.....	38
Table 26. Fine adjust—P2.4.....	38
Table 27. Digital input—P3.....	38
Table 28. Analog output—P4.....	40
Table 29. Digital output—P5.....	41
Table 30. Drive control—P7.....	43
Table 31. Motor control—P8.....	44
Table 32. Protections—P9.....	45
Table 33. Preset speed—P12.....	48
Table 34. Brake—P14.....	48
Table 35. FB process data input Sel—P20.1.....	49
Table 36. FB process data output Sel—P20.2.....	49
Table 37. Basic setting—P20.3.1.....	51
Table 38. Modbus RTU—P20.3.2.....	51
Table 39. BACnet MS/TP—P20.3.3.....	51
Table 40. Terminal: SWD—P20.3.4.....	52
Table 41. EtherNet/IP—P20.4.....	52
Table 42. Modbus TCP—P20.5.....	53
Table 43. Web UI—P20.6.....	53
Table 44. Basic setting—P21.1.....	53
Table 45. Version info.—P21.2.....	55
Table 46. Application info.—P21.3.....	55
Table 47. User info.—P21.4.....	55
Table 48. Operate mode—O.....	55



## List of tables, continued

Table 49. Multi-pump and fan application default I/O connection. . . . .	66
Table 50. Drive communication ports. . . . .	67
Table 51. Monitor—M. . . . .	68
Table 52. Basic parameters—P1. . . . .	70
Table 53. Basic setting—P2.1. . . . .	71
Table 54. AI1 settings—P2.2. . . . .	71
Table 55. AI2 settings—P2.3. . . . .	71
Table 56. Fine adjust—P2.4. . . . .	72
Table 57. Digital input—P3. . . . .	72
Table 58. Analog output—P4. . . . .	75
Table 59. Digital output—P5. . . . .	76
Table 60. Drive control—P7. . . . .	79
Table 61. Motor control—P8. . . . .	80
Table 62. Protections—P9. . . . .	80
Table 63. PID controller 1—P10. . . . .	83
Table 64. Preset speed—P12. . . . .	88
Table 65. Brake—P14. . . . .	88
Table 66. Fire mode—P15. . . . .	89
Table 67. Second motor parameter—P16. . . . .	89
Table 68. Basic setting—P17.1. . . . .	90
Table 69. Redundant drive—P17.2. . . . .	90
Table 70. Basic setting—P18.1. . . . .	91
Table 71. Operation mode—P18.2.1. . . . .	91
Table 72. Multi-pump status—P18.2.2. . . . .	92
Table 73. Network status—P18.2.3. . . . .	92
Table 74. Latest fault code—P18.3.1. . . . .	92
Table 75. Output frequency—P18.3.2. . . . .	92
Table 76. Motor voltage—P18.3.3. . . . .	93
Table 77. Motor current—P18.3.4. . . . .	93
Table 78. Motor torque—P18.3.5. . . . .	93
Table 79. Motor power—P18.3.6. . . . .	93
Table 80. Motor speed—P18.3.7. . . . .	93
Table 81. Run time—P18.3.8. . . . .	93
Table 82. Multi-pump single drive—P18.4. . . . .	94
Table 83. Multi-pump multi drive—P18.5. . . . .	94
Table 84. Protections—P18.6. . . . .	95
Table 85. Real time clock—P19. . . . .	96
Table 86. FB process data input Sel—P20.1. . . . .	97
Table 87. FB process data output Sel—P20.2. . . . .	97
Table 88. Basic setting—P20.3.1. . . . .	99
Table 89. Modbus RTU—P20.3.2. . . . .	99
Table 90. BACnet MS/TP—P20.3.3. . . . .	100
Table 91. Terminal: SWD—P20.3.4. . . . .	100
Table 92. EtherNet/IP—P20.4. . . . .	101
Table 93. Modbus TCP—P20.5. . . . .	101
Table 94. Web UI—P20.6. . . . .	101
Table 95. Basic setting—P21.1. . . . .	102
Table 96. Version info.—P21.2. . . . .	103

## List of tables, continued

Table 97. Application info.—P21.3. . . . .	103
Table 98. User info.—P21.4. . . . .	103
Table 99. Operate mode—O. . . . .	103
Table 100. Monitor—M. . . . .	108
Table 101. Basic parameters—P1. . . . .	110
Table 102. Basic setting—P2.1. . . . .	111
Table 103. AI1 settings—P2.2. . . . .	111
Table 104. AI2 settings—P2.3. . . . .	111
Table 105. Fine adjust—P2.4. . . . .	112
Table 106. Digital input—P3. . . . .	112
Table 107. Analog output—P4. . . . .	114
Table 108. Digital output—P5. . . . .	115
Table 109. Drive control—P7. . . . .	118
Table 110. Motor control—P8. . . . .	119
Table 111. Protections—P9. . . . .	120
Table 112. PID controller 1—P10. . . . .	123
Table 113. PID controller 2—P11. . . . .	127
Table 114. Preset speed—P12. . . . .	131
Table 115. Brake—P14. . . . .	131
Table 116. Fire mode—P15. . . . .	131
Table 117. Second motor parameter—P16. . . . .	132
Table 118. Basic setting—P17.1. . . . .	132
Table 119. Redundant drive—P17.2. . . . .	132
Table 120. Basic setting—P18.1. . . . .	132
Table 121. Operation mode—P18.2.1. . . . .	134
Table 122. Multi-pump status—P18.2.2. . . . .	134
Table 123. Network status—P18.2.3. . . . .	134
Table 124. Latest fault code—P18.3.1. . . . .	135
Table 125. Output frequency—P18.3.2. . . . .	135
Table 126. Motor voltage—P18.3.3. . . . .	135
Table 127. Motor current—P18.3.4. . . . .	135
Table 128. Motor torque—P18.3.5. . . . .	135
Table 129. Motor power—P18.3.6. . . . .	136
Table 130. Motor speed—P18.3.7. . . . .	136
Table 131. Run time—P18.3.8. . . . .	136
Table 132. Multi-pump single drive—P18.4. . . . .	136
Table 133. Multi-pump multi drive—P18.5. . . . .	137
Table 134. Protections—P18.6. . . . .	137
Table 135. Real time clock—P19. . . . .	138
Table 136. FB process data input Sel—P20.1. . . . .	139
Table 137. FB process data output Sel—P20.2. . . . .	139
Table 138. Basic setting—P20.3.1. . . . .	142
Table 139. Modbus RTU—P20.3.2. . . . .	142
Table 140. BACnet MS/TP—P20.3.3. . . . .	142
Table 141. Terminal: SWD—P20.3.4. . . . .	143
Table 142. EtherNet/IP—P20.4. . . . .	143
Table 143. Modbus TCP—P20.5. . . . .	144
Table 144. Web UI—P20.65. . . . .	144

## List of tables, continued

Table 145. Basic setting—P21.1. . . . .	144
Table 146. Version info.—P21.2. . . . .	145
Table 147. Application info.—P21.3. . . . .	145
Table 148. User info.—P21.4. . . . .	145
Table 149. Operate mode—O. . . . .	145
Table 150. Multi-purpose application default I/O configuration. . . . .	149
Table 151. Drive communication ports. . . . .	150
Table 152. Monitor—M. . . . .	151
Table 153. Basic parameters—P1. . . . .	153
Table 154. Basic setting—P2.1. . . . .	154
Table 155. AI1 settings—P2.2. . . . .	154
Table 156. AI2 settings—P2.3. . . . .	154
Table 157. Fine adjust—P2.4. . . . .	154
Table 158. Digital input—P3. . . . .	155
Table 159. Analog output—P4. . . . .	157
Table 160. Digital output—P5. . . . .	158
Table 161. Logic function—P6. . . . .	162
Table 162. Drive control—P7. . . . .	163
Table 163. Motor control—P8. . . . .	164
Table 164. Protections—P9. . . . .	165
Table 165. PID controller 1—P10. . . . .	169
Table 166. PID controller 2—P11. . . . .	175
Table 167. Preset speed—P12. . . . .	178
Table 168. Torque control—P13. . . . .	178
Table 169. Brake—P14. . . . .	179
Table 170. Fire mode—P15. . . . .	180
Table 171. Second motor parameter—P16. . . . .	180
Table 172. Basic setting—P17.1. . . . .	181
Table 173. Redundant drive—P17.2. . . . .	181
Table 174. Basic setting—P18.1. . . . .	182
Table 175. Operation mode—P18.2.1. . . . .	182
Table 176. Multi-pump status—P18.2.2. . . . .	182
Table 177. Network status—P18.2.3. . . . .	183
Table 178. Latest fault code—P18.3.1. . . . .	183
Table 179. Output frequency—P18.3.2. . . . .	183
Table 180. Motor voltage—P18.3.3. . . . .	183
Table 181. Motor current—P18.3.4. . . . .	184
Table 182. Motor torque—P18.3.5. . . . .	184
Table 183. Motor power—P18.3.6. . . . .	184
Table 184. Motor speed—P18.3.7. . . . .	184
Table 185. Run time—P18.3.8. . . . .	184
Table 186. Multi-pump single drive—P18.4. . . . .	184
Table 187. Multi-pump multi drive—P18.5. . . . .	185
Table 188. Protections—P18.6. . . . .	185
Table 189. Real time clock—P19. . . . .	186
Table 190. FB process data input Sel—P20.1. . . . .	187
Table 191. FB process data output Sel—P20.2. . . . .	187
Table 192. Basic setting—P20.3.1. . . . .	189

**List of tables, continued**

Table 193. Modbus RTU—P20.3.2..... **189**  
Table 194. BACnet MS/TP—P20.3.3. .... **190**  
Table 195. Terminal: SWD—P20.3.4. .... **190**  
Table 196. EtherNet/IP—P20.4. .... **191**  
Table 197. Modbus TCP—P20.5..... **191**  
Table 198. Web UI—P20.6..... **191**  
Table 199. Basic setting—P21.1..... **192**  
Table 200. Version info.—P21.2..... **192**  
Table 201. Application info.—P21.3. .... **192**  
Table 202. User info.—P21.4..... **193**  
Table 203. Operate mode—O. .... **193**  
Table 204. Active faults. .... **291**  
Table 205. History faults. .... **291**

## Safety



**WARNING!**  
**DANGEROUS ELECTRICAL VOLTAGE!**

### Before commencing the installation

- Disconnect the power supply of the device
- Ensure that devices cannot be accidentally restarted
- Verify isolation from the supply
- Earth and short circuit the device
- Cover or enclose any adjacent live components
- Only suitably qualified personnel in accordance with EN 50110-1/-2 (VDE 0105 Part 100) may work on this device/system
- Before installation and before touching the device ensure that you are free of electrostatic charge
- The functional earth (FE, PES) must be connected to the protective earth (PE) or the potential equalization. The system installer is responsible for implementing this connection
- Connecting cables and signal lines should be installed so that inductive or capacitive interference does not impair the automation functions
- Install automation devices and related operating elements in such a way that they are well protected against unintentional operation
- Suitable safety hardware and software measures should be implemented for the I/O interface so that an open circuit on the signal side does not result in undefined states in the automation devices
- Ensure a reliable electrical isolation of the extra-low voltage of the 24 V supply. Only use power supply units complying with IEC 60364-4-41 (VDE 0100 Part 410) or HD384.4.41 S2
- Deviations of the input voltage from the rated value must not exceed the tolerance limits given in the specifications, otherwise this may cause malfunction and dangerous operation
- Emergency stop devices complying with IEC/EN 60204-1 must be effective in all operating modes of the automation devices. Unlatching the emergency-stop devices must not cause a restart
- Devices that are designed for mounting in housings or control cabinets must only be operated and controlled after they have been installed and with the housing closed. Desktop or portable units must only be operated and controlled in enclosed housings
- Measures should be taken to ensure the proper restart of programs interrupted after a voltage dip or failure. This should not cause dangerous operating states even for a short time. If necessary, emergency-stop devices should be implemented
- Wherever faults in the automation system may cause injury or material damage, external measures must be implemented to ensure a safe operating state in the event of a fault or malfunction (for example, by means of separate limit switches, mechanical interlocks, and so on)
- Depending on their degree of protection, adjustable frequency drives may contain live bright metal parts, moving or rotating components, or hot surfaces during and immediately after operation
- Removal of the required covers, improper installation, or incorrect operation of motor or adjustable frequency drive may cause the failure of the device and may lead to serious injury or damage
- The applicable national accident prevention and safety regulations apply to all work carried out on live adjustable frequency drives
- The electrical installation must be carried out in accordance with the relevant regulations (for example, with regard to cable cross sections, fuses, PE)
- Transport, installation, commissioning, and maintenance work must be carried out only by qualified personnel (IEC 60364, HD 384 and national occupational safety regulations)
- Installations containing adjustable frequency drives must be provided with additional monitoring and protective devices in accordance with the applicable safety regulations. Modifications to the adjustable frequency drives using the operating software are permitted
- All covers and doors must be kept closed during operation
- To reduce hazards for people or equipment, the user must include in the machine design measures that restrict the consequences of a malfunction or failure of the drive (increased motor speed or sudden standstill of motor). These measures include:
  - Other independent devices for monitoring safety-related variables (speed, travel, end positions, and so on)
  - Electrical or non-electrical system-wide measures (electrical or mechanical interlocks)
- Never touch live parts or cable connections of the adjustable frequency drive after it has been disconnected from the power supply. Due to the charge in the capacitors, these parts may still be live after disconnection. Fit appropriate warning signs

## Definitions and symbols

---

### **WARNING**

---

**This symbol indicates high voltage. It calls your attention to items or operations that could be dangerous to you and other persons operating this equipment. Read the message and follow the instructions carefully. This symbol is the “Safety Alert Symbol”. It occurs with either of two signal words: CAUTION or WARNING, as described below.**

---

### **WARNING**

---

**Indicates a potentially hazardous situation which, if not avoided, can result in serious injury or death.**

---

### **CAUTION**

---

Indicates a potentially hazardous situation which, if not avoided, can result in minor to moderate injury, or serious damage to the product. The situation described in the CAUTION may, if not avoided, lead to serious results. Important safety measures are described in CAUTION (as well as WARNING).

---

## Hazardous high voltage

---

### **WARNING**

---

**Motor control equipment and electronic controllers are connected to hazardous line voltages. When servicing drives and electronic controllers, there may be exposed components with housings or protrusions at or above line potential. Extreme care should be taken to protect against shock.**

Stand on an insulating pad and make it a habit to use only one hand when checking components. Always work with another person in case an emergency occurs. Disconnect power before checking controllers or performing maintenance. Be sure equipment is properly grounded. Wear safety glasses whenever working on electronic controllers or rotating machinery.

## Warnings and cautions

This manual contains clearly marked cautions and warnings which are intended for your personal safety and to avoid any unintentional damage to the product or connected appliances. Please read the information included in cautions and warnings carefully.

---

### **WARNING**

---

**The relay outputs and other I/O-terminals may have a dangerous control voltage present even when PowerXL DG1 is disconnected from mains.**

---

### **WARNING**

---

**Be sure not to plug the Ethernet IP cable to the terminal under the keypad! This might harm your personal computer.**

---

### **WARNING**

---

**Be sure not to plug the Modbus TCP cable to the terminal under the keypad! This might harm your personal computer.**

---

### **CAUTION**

---

Remove external control signal before resetting the fault to prevent unintentional restart of the drive.

## Important safety information

### Hazardous high voltage

---

 **WARNING**

The components of the power unit of PowerXL Series are live when the AC drive is connected to mains potential. Coming into contact with this voltage is extremely dangerous and may cause death or severe injury.

---

 **WARNING**

The motor terminals U, V, W and the brake resistor terminals are live when PowerXL Series is connected to mains, even if the motor is not running.

---

 **WARNING**

After disconnecting the AC drive from the mains, wait until the indicators on the keypad go out (if no keypad is attached see the indicators on the cover). Wait 5 more minutes before doing any work on the connections of PowerXL Series. Do not open the cover before this time has expired. After expiration of this time, use a measuring equipment to absolutely ensure that no voltage is present. Always ensure absence of voltage before starting any electrical work!

---

 **WARNING**

The control I/O-terminals are isolated from the mains potential. However, the relay outputs and other I/O-terminals may have a dangerous control voltage present even when PowerXL DG1 is disconnected from mains.

---

 **WARNING**

Before connecting the AC drive to mains, confirm that the front and cable covers of PowerXL DG1 are closed.

---

 **WARNING**

During a ramp stop (see the Application Manual), the motor is still generating voltage to the drive. Therefore, do not touch the components of the AC drive before the motor has completely stopped. Wait until the indicators on the keypad go out (if no keypad is attached see the indicators on the cover). Wait additional 5 minutes before starting any work on the drive.

## Important warnings

---

 **WARNING**

PowerXL Series AC drive is meant for fixed installations only.

---

 **WARNING**

Do not perform any measurements when the AC drive is connected to the mains.

---

 **WARNING**

The ground leakage current of PowerXL Series AC drives exceeds 3.5 mA AC. According to standard EN61800-5-1, a reinforced protective ground connection must be ensured.

---

 **WARNING**

If the AC drive is used as a part of a machine, the machine manufacturer is responsible for providing the machine with a supply disconnecting device (EN 60204-1).

---

 **WARNING**

Only spare parts delivered by Eaton can be used.

---

 **WARNING**

At power-up, power brake or fault reset the motor will start immediately if the start signal is active, unless the pulse control for Start/Stop logic has been selected. Furthermore, the I/O functionalistic (including start inputs) may change if parameters, applications or software are changed. Disconnect, therefore, the motor if an unexpected start can cause danger.

---

 **WARNING**

The motor starts automatically after automatic fault reset if the auto restart function is activated. See the Application Manual for more detailed information.

---

 **WARNING**

Prior to measurements on the motor or the motor cable, disconnect the motor cable from the AC drive.

---

 **WARNING**

Do not touch the components on the circuit boards. Static voltage discharge may damage the components.

---

 **WARNING**

Check that the EMC level of the AC drive corresponds to the requirements of your supply network.

## Additional cautions

---

### CAUTION

---

The PowerXL DG1 AC drive must always be grounded with an grounding conductor connected to the grounding terminal marked with. The ground leakage current of PowerXL DG1 exceeds 3.5 mA AC. According to EN61800-5-1, one or more of the following conditions for the associated protective circuit shall be satisfied:

- a) The protective conductor shall have a cross-sectional area of at least 10 mm<sup>2</sup> Cu or 16 mm<sup>2</sup> Al, through its total run
- b) Where the protective conductor has a cross-sectional area of less than 10 mm<sup>2</sup> Cu or 16 mm<sup>2</sup> Al, a second protective conductor of at least the same cross-sectional area shall be provided up to a point where the protective conductor has a cross-sectional area not less than 10 mm<sup>2</sup> Cu or 16 mm<sup>2</sup> Al
- c) Automatic disconnection of the supply in case of loss of continuity of the protective conductor. The cross-sectional area of every protective grounding conductor that does not form part of the supply cable or cable enclosure shall, in any case, be not less than:
  - 2.5mm<sup>2</sup> if mechanical protection is provided or
  - 4 mm<sup>2</sup> if mechanical protection is not provided.

The ground fault protection inside the AC drive protects only the drive itself against ground faults in the motor or the motor cable. It is not intended for personal safety. The ground fault protection inside the AC drive protects only the drive itself against ground faults in the motor or the motor cable. It is not intended for personal safety. Due to the high capacitive currents present in the AC drive, fault current protective switches may not function properly.

Do not perform any voltage withstand tests on any part of PowerXL Series. There is a certain procedure according to which the tests shall be performed. Ignoring this procedure may result in damaged product.



## Sécurité



### **AVERTISSEMENT ! TENSION ÉLECTRIQUE DANGEREUSE !**

#### **Avant de commencer l'installation**

- Débrancher l'alimentation de l'appareil
- S'assurer que les dispositifs ne peuvent pas être accidentellement redémarrés
- Vérifier l'isolement de l'alimentation
- Mettre l'appareil à la terre et le protéger contre les courts-circuits
- Couvrir ou enfermer tout composant sous tension adjacent
- Seul le personnel qualifié conformément à la norme EN 50110-1/-2 (VDE 0105 Partie 100) peut travailler sur cet appareil/ce système
- Avant l'installation et avant de toucher l'appareil, s'assurer de ne porter aucune charge électrostatique
- La terre fonctionnelle (FE, PSE) doit être raccordée à la terre de protection (PE) ou la compensation de potentiel. L'installateur du système a la responsabilité d'assurer cette connexion
- Les câbles de connexion et les lignes de signal doivent être installés de façon à ce que les interférences capacitatives ou inductives ne compromettent pas les fonctions d'automatisation
- Installer les appareils d'automatisation et les éléments de fonctionnement associés de manière à ce qu'ils soient bien protégés contre tout fonctionnement accidentel
- Des dispositifs de sécurité matériels et logiciels appropriés doivent être utilisés en rapport avec l'interface des E/S afin qu'un circuit ouvert sur le côté signal ne résulte pas en états indéfinis dans les dispositifs d'automatisation
- Assurer une isolation électrique fiable sur le côté tension extra basse de l'alimentation 24 V. Utiliser uniquement des blocs d'alimentation conformes à la norme CEI 60364-4-41 (VDE 0100, partie 410) ou HD384.4.41 S2
- Les écarts entre la tension d'entrée et la tension nominale ne doivent pas dépasser les limites de tolérance indiquées dans les spécifications, au risque de provoquer un mauvais fonctionnement et une utilisation dangereuse du système
- Les dispositifs d'arrêt d'urgence conformes à la norme CEI/EN 60204-1 doivent être efficace dans tous les modes de fonctionnement des dispositifs d'automatisation. Le déverrouillage des dispositifs d'arrêt d'urgence ne doit pas entraîner un redémarrage
- Les dispositifs conçus pour un montage dans des boîtiers ou armoires de commande ne doivent être utilisés et contrôlés qu'après avoir été installés et avec le boîtier fermé. Les unités de bureau ou portatives ne doivent être utilisées et contrôlées que dans leurs boîtiers fermés
- Des mesures doivent être prises pour assurer un bon redémarrage des programmes interrompus après une chute ou une panne de tension. Ceci ne doit pas causer des états de fonctionnement dangereux, même pour un court laps de temps. Si nécessaire, des dispositifs d'arrêt d'urgence doivent être utilisés
- Quand des défaillances du système d'automatisation peuvent entraîner des blessures ou des dommages matériels, des mesures externes doivent être appliquées pour assurer un état de fonctionnement sans danger en cas de panne ou de mauvais fonctionnement (par exemple au moyen de disjoncteurs séparés, de verrouillages mécaniques, etc.)
- En fonction de leur degré de protection, les entraînements à fréquence variable peuvent contenir des pièces métalliques sous tension, des composants rotatifs ou en mouvement et des surfaces brûlantes, pendant le fonctionnement et immédiatement après l'arrêt
- Le retrait des protections requises, une installation incorrecte ou un mauvais fonctionnement du moteur ou de l'entraînement à fréquence variable peuvent causer la défaillance de l'appareil et entraîner des blessures graves et des dommages importants
- La réglementation nationale applicable en matière de sécurité et de prévention des accidents s'applique à tous les travaux effectués sur les entraînements à fréquence variable sous tension
- L'installation électrique doit être effectuée conformément aux réglementations applicables (par exemple, en ce qui concerne les sections transversales des câbles, les fusibles, la mise à la terre de protection)
- Le transport, l'installation, la mise en service et les travaux de maintenance doivent être effectués uniquement par un personnel qualifié (IEC 60364, HD 384 et règles de sécurité du travail)
- Les installations contenant des entraînements à fréquence variable doivent être équipées de dispositifs de surveillance et de protection, conformément aux réglementations applicables en matière de sécurité. Les modifications des entraînements à fréquence variable réalisées à l'aide du logiciel d'exploitation sont autorisées
- Toutes les protections et les portes doivent être maintenues fermées pendant le fonctionnement

- Pour réduire les risques d'accidents et de dommages matériels, l'utilisateur doit inclure dans la conception de la machine des mesures limitant les conséquences de panne ou de mauvais fonctionnement de l'entraînement (augmentation de la vitesse ou arrêt soudain du moteur). Ces mesures comprennent :

- Autres dispositifs indépendants de surveillance des variables en rapport avec la sécurité (vitesse, voyages, positions d'extrémité, etc.)
- Mesures électriques ou non électriques appliquées à l'ensemble du système (verrouillages électriques ou mécaniques)
- Ne jamais toucher les pièces sous tension ni les connexions des câbles de l'entraînement à fréquence variable après leur déconnexion de l'alimentation. En raison de la charge dans les condensateurs, ces pièces peuvent être encore sous tension après la déconnexion. Installer les panneaux d'avertissement appropriés

Lire ce manuel en entier et s'assurer de bien comprendre les procédures avant de tenter d'installer, de configurer, d'utiliser et d'effectuer tout travail d'entretien sur cet entraînement à fréquence variable DG1.

## Définitions et symboles

### AVERTISSEMENT

Ce symbole indique une haute tension. Il attire l'attention sur les éléments ou les opérations qui pourraient être dangereux pour les personnes utilisant cet équipement. Lire attentivement le message et suivre attentivement les instructions.



Ce symbole est le « symbole d'alerte de sécurité ». Il accompagne les deux termes d'avertissement suivants : MISE EN GARDE ou AVERTISSEMENT, comme décrit ci-dessous.

### AVERTISSEMENT

Indique une situation potentiellement dangereuse qui, si elle n'est pas évitée, peut entraîner des blessures graves ou la mort.

### MISE EN GARDE

Indique une situation potentiellement dangereuse qui, si elle n'est pas évitée, peut entraîner des blessures légères à modérées et d'importants dégâts matériels. La situation décrite dans la MISE EN GARDE peut, si elle n'est pas évitée, entraîner des conséquences graves. Des mesures de sécurité importantes sont décrites dans les MISES EN GARDE (ainsi que dans les AVERTISSEMENTS).

## Haute tension dangereuse

### AVERTISSEMENT

L'équipement de contrôle du moteur et les contrôleurs électroniques sont branchés sur des tensions secteur dangereuses. Lors de l'entretien des entraînements et des contrôleurs électroniques, il peut y avoir des composants exposés avec des boîtiers ou des protubérances au niveau du potentiel du réseau ou au-dessus. Toutes les précautions doivent être prises pour se protéger contre les chocs électriques.

- Se tenir sur un tapis isolant et prendre l'habitude de n'utiliser qu'une seule main pour vérifier les composants
- Toujours travailler avec une autre personne lorsqu'une situation d'urgence se produit
- Débrancher l'alimentation avant de vérifier les contrôleurs ou d'effectuer des travaux d'entretien
- S'assurer que l'équipement est correctement relié à la terre
- Porter des lunettes de sécurité lors des travaux sur les contrôleurs électroniques ou les machines rotatives

### AVERTISSEMENT

Les composants de la section d'alimentation de l'entraînement restent sous tension après la coupure de la tension d'alimentation. Après la déconnexion de l'alimentation, attendre au moins cinq minutes avant de retirer le couvercle pour permettre la décharge des condensateurs du circuit intermédiaire.

Prêter attention aux avertissements signalant des dangers !



**DANGER**  
**5 MIN**

### AVERTISSEMENT

Risque de choc électrique – risque de blessures !  
Effectuer le câblage uniquement si l'unité n'est plus sous tension.

### AVERTISSEMENT

Ne pas effectuer de modifications sur l'entraînement CA lorsqu'il est connecté à l'alimentation secteur.

## Avertissements et mises en garde

---

### AVERTISSEMENT

---

S'assurer de mettre l'appareil à la terre en suivant les instructions de ce manuel. Les unités non mises à la terre peuvent causer des chocs électriques et des incendies.

---

### AVERTISSEMENT

---

Cet équipement ne doit être installé, réglé et entretenu que par un personnel d'entretien électrique qualifié connaissant la construction et le fonctionnement de ce type d'équipement, ainsi que les risques encourus. Le non-respect de cette précaution peut entraîner la mort ou des blessures graves.

---

### AVERTISSEMENT

---

Les composants à l'intérieur de l'entraînement sont sous tension lorsque l'entraînement est branché à l'alimentation. Le contact avec cette tension est extrêmement dangereux et peut causer la mort ou des blessures graves.

---

### AVERTISSEMENT

---

Les bornes de phase (L1, L2, L3), les bornes du moteur (U, V, W) et les bornes de résistance de liaison CC/frein (DC-, DC+/R+, R-) sont sous tension lorsque l'entraînement est branché à l'alimentation, même si le moteur ne tourne pas. Le contact avec cette tension est extrêmement dangereux et peut causer la mort ou des blessures graves.

---

### AVERTISSEMENT

---

Même si les bornes E/S de commande sont isolées de la tension secteur, les sorties de relais et les autres bornes E/S peuvent présenter une tension dangereuse même lorsque l'entraînement est débranché. Le contact avec cette tension est extrêmement dangereux et peut causer la mort ou des blessures graves.

---

### AVERTISSEMENT

---

Cet équipement a un grand courant de fuite capacitif pendant le fonctionnement, ce qui peut mettre les pièces du boîtier à un niveau supérieur au potentiel de terre. Une mise à la terre appropriée, telle que décrite dans ce manuel, est nécessaire. Le non-respect de cette précaution peut entraîner la mort ou des blessures graves.

---

### AVERTISSEMENT

---

Avant de mettre l'entraînement sous tension, s'assurer que les protections avant et des câbles sont fermées et attachées pour empêcher l'exposition à d'éventuelles défaillances électriques. Le non-respect de cette précaution peut entraîner la mort ou des blessures graves.

---

### AVERTISSEMENT

---

Un dispositif de protection/déconnexion en amont doit être fourni, tel que requis par le code électrique national (NEC®). Le non-respect de cette précaution peut entraîner la mort ou des blessures graves.

---

### AVERTISSEMENT

---

Cet entraînement peut causer un courant CC dans le conducteur de mise à la terre de protection. Lorsqu'un dispositif de protection ou de surveillance à courant résiduel est utilisé pour la protection en cas de contact direct ou indirect, seul un dispositif de type B est autorisé sur le côté alimentation de ce produit.

---

### AVERTISSEMENT

---

Ne travailler sur le câblage qu'après que l'entraînement a été correctement monté et attaché.

---

### AVERTISSEMENT

---

Avant d'ouvrir les couvercles de l'entraînement :

- Débrancher toute l'alimentation allant à l'entraînement, y compris l'alimentation de commande externe pouvant être présente
- Attendre un minimum de cinq minutes après l'extinction de tous les voyants du clavier. Cela permet aux condensateurs de bus CC de se décharger
- Une tension dangereuse peut rester dans les condensateurs de bus CC même si l'alimentation a été coupée. Confirmer que les condensateurs sont entièrement déchargés en mesurant la tension à l'aide d'un multimètre réglé pour mesurer la tension CC

Le non-respect de cette précaution peut entraîner la mort ou des blessures graves.

---

### AVERTISSEMENT

---

L'ouverture du dispositif de protection du circuit de dérivation peut indiquer que le courant de défaut a été interrompu. Pour réduire le risque d'incendie ou de choc électrique, les pièces porteuses de courant et les autres composants du contrôleur doivent être examinés et remplacés s'ils sont endommagés. Si l'élément de courant d'un relais de surcharge a grillé, le relais de surcharge doit être intégralement remplacé.

---

## AVERTISSEMENT

---

**Le fonctionnement de cet équipement nécessite le respect des instructions d'installation et de fonctionnement détaillées fournies dans le manuel d'installation/de fonctionnement destiné à être utilisé avec ce produit. Ces informations sont fournies sur le CD-ROM, la disquette ou tout autre périphérique de stockage inclus dans l'emballage contenant ce dispositif. Ce support doit être conservé avec cet appareil à tout moment. Une copie papier de ces informations peut être commandée auprès du service de documentation Eaton.**

---

## AVERTISSEMENT

---

**Avant de procéder à l'entretien de l'entraînement :**

- **Débrancher toute l'alimentation allant à l'entraînement, y compris l'alimentation de commande externe pouvant être présente**
- **Placer une étiquette « NE PAS UTILISER » sur le dispositif de déconnexion**
- **Verrouiller le dispositif de déconnexion en position ouverte**

**Le non-respect de ces instructions peut entraîner la mort ou des blessures graves.**

---

## AVERTISSEMENT

---

**Les sorties de l'entraînement (U, V, W) ne doivent pas être connectées à la tension d'entrée ni à l'alimentation secteur, car ceci pourrait gravement endommager l'appareil et causer un incendie.**

---

## AVERTISSEMENT

---

**Le dissipateur de chaleur et/ou le boîtier externe peuvent atteindre une température élevée.**

**Prêter attention aux avertissements signalant des dangers !**



**Surface brûlante – Risque de brûlure. NE PAS TOUCHER !**

---

## MISE EN GARDE

---

Toute modification électrique ou mécanique de cet entraînement sans consentement écrit préalable d'Eaton annule toutes les garanties, peut entraîner un danger pour la sécurité et annuler l'homologation UL®.

---

## MISE EN GARDE

---

Installer cet entraînement sur une matière résistante aux flammes, telle qu'une plaque d'acier, pour réduire les risques d'incendie.

---

## MISE EN GARDE

---

Installer cet entraînement sur une surface perpendiculaire capable de supporter le poids de l'entraînement et non soumise à des vibrations afin de diminuer les risques de chute et de dommage de l'entraînement, ainsi que les risques de blessures.

---

## MISE EN GARDE

---

Empêcher la pénétration de corps étrangers, tels que morceaux de fils et copeaux métalliques, dans le boîtier de l'entraînement, car ceci pourrait provoquer la formation d'un arc électrique et un incendie.

---

## MISE EN GARDE

---

Installer cet entraînement dans une pièce bien aérée non soumise à des températures extrêmes, à une forte humidité ou à la condensation. Éviter les endroits directement exposés au soleil ou présentant de fortes concentrations de poussières, des gaz corrosifs, des gaz explosifs, des gaz inflammables, ou des vapeurs de liquide de meulage, etc. Une installation inadéquate peut entraîner un risque d'incendie.

---

## MISE EN GARDE

---

Lors de la sélection de la section transversale des câbles, prendre en compte la chute de tension dans des conditions de charge. La prise en compte d'autres paramètres relève de la responsabilité de l'utilisateur.

Il relève de la responsabilité de l'utilisateur de respecter toutes les normes électriques nationales et internationales en vigueur concernant la mise à la terre de protection de l'ensemble de l'équipement.

---

## MISE EN GARDE

---

Les spécifications minimum relatives aux sections transversales des conducteurs de terre de protection indiquées dans ce manuel doivent être respectées.

Le courant de fuite de cet équipement dépasse 3,5 mA (CA). La taille minimum du conducteur de la mise à la terre de protection doit être conforme aux exigences de la norme EN 61800-5-1 et/ou aux réglementations de sécurité locales.

---

## MISE EN GARDE

---

Les courants de fuite de ce convertisseur de fréquence sont supérieures à 3,5 mA (CA). Conformément à la norme CEI/EN 61800-5-1, un conducteur de mise à la terre de l'équipement supplémentaire possédant la même superficie de coupe transversale que le conducteur de mise à la terre de protection d'origine doit être branché, ou la section transversale du conducteur de mise à la terre de l'équipement doit être d'au moins 10 mm<sup>2</sup> Cu. Seul un conducteur en cuivre doit être utilisé avec cet entraînement.

---

## MISE EN GARDE

---

Les entrées anti-rebond ne sont pas permises dans le schéma du circuit de sécurité. Des disjoncteurs de courant résiduel (RCD) ne peuvent être installés qu'entre le réseau de courant alternatif et l'entraînement.

---

## MISE EN GARDE

---

Les entrées anti-rebond ne sont pas permises dans le schéma du circuit de sécurité. Si plusieurs moteurs sont connectés à un entraînement, des contacteurs doivent être conçus pour les moteurs individuels conformément à la catégorie d'utilisation AC-3.

Sélectionner du contacteur du moteur en fonction du courant de fonctionnement nominal du moteur à connecter.

---

## MISE EN GARDE

---

Les entrées anti-rebond ne sont pas permises dans le schéma du circuit de sécurité. Une commutation entre l'entraînement et l'alimentation d'entrée doit avoir lieu dans un état sans tension.

---

## MISE EN GARDE

---

Les entrées anti-rebond ne sont pas permises dans le schéma du circuit de sécurité. Risque d'incendie !

Utiliser uniquement des câbles, des interrupteurs de protection et des contacteurs indiquant le courant nominal permis.

---

## MISE EN GARDE

---

Avant de connecter l'entraînement à l'alimentation secteur CA, s'assurer que les réglages de la classe de protection CEM sont correctement effectués selon les instructions de ce manuel.

- Si l'entraînement doit être utilisé dans un réseau de distribution flottant, retirer les vis au niveau des VOM et CEM. Voir « Installation dans un réseau à une phase connectée à la terre (corner-grounded) » et « Installation dans un réseau IT »
- Débrancher le filtre CEM interne lors de l'installation de l'entraînement sur un réseau IT (système d'alimentation non mis à la terre ou système d'alimentation électrique mis à la terre haute résistance [plus de 30 ohms]) pour ne pas que le système soit connecté au potentiel de terre via les condensateurs du filtre CEM. Ceci peut être une cause de dangers ou endommager l'entraînement
- Débrancher le filtre CEM interne lors de l'installation de l'entraînement sur un système TN à une phase connectée à la terre pour ne pas endommager l'entraînement

**Note:** Lorsque le filtre CEM interne est débranché, l'entraînement peut ne pas être conforme aux normes de compatibilité électromagnétique.

- Ne pas tenter d'installer ou de retirer les vis des VOM et CEM lorsque l'alimentation est appliquée aux bornes d'entrée de l'entraînement

---

## Sécurité du moteur et de l'équipement

---

---

### MISE EN GARDE

---

n'effectuer aucun test de résistance de tension ou au mégohmmètre sur toute partie de l'entraînement ou de ses composants. Un test inadéquat peut entraîner des dommages.

---

### MISE EN GARDE

---

Avant tout test ou mesure du moteur ou du câble du moteur, débrancher le câble du moteur au niveau des bornes de sortie de l'entraînement (U, V, W) pour éviter d'endommager ce dernier lors des tests.

---

### MISE EN GARDE

---

Ne toucher aucun composant sur les cartes de circuit. Les décharges d'électricité statique peuvent endommager les composants.

---

### MISE EN GARDE

---

Avant de mettre le moteur en marche, vérifier qu'il est correctement monté et aligné avec l'équipement entraîné. S'assurer que le démarrage du moteur ne risque pas de provoquer des blessures ou d'endommager l'équipement connecté au moteur.

---

### MISE EN GARDE

---

Régler la vitesse maximale du moteur (fréquence) dans l'entraînement conformément aux exigences du moteur et de l'équipement qui lui est connecté. Des réglages de fréquence maximum incorrects peuvent endommager le moteur ou l'équipement et causer des blessures.

---

### MISE EN GARDE

---

Avant d'inverser le sens de rotation du moteur, veiller à ce que cela ne risque pas de provoquer des blessures ou des dommages matériels.

---

### MISE EN GARDE

---

S'assurer qu'aucun condensateur de correction de puissance n'est connecté à la sortie de l'entraînement ou aux bornes du moteur pour éviter un mauvais fonctionnement de l'entraînement et des dommages potentiels.

---

### MISE EN GARDE

---

S'assurer que les bornes de sortie de l'entraînement (U, V, W) ne sont pas connectées à l'alimentation secteur, ce qui pourrait causer de graves dommages à l'entraînement.

---

### MISE EN GARDE

---

Lorsque les bornes de commande de deux ou plusieurs unités d'entraînement sont raccordées en parallèle, la tension auxiliaire de ces connexions de commande doit être fournie par une source unique, qui peut être soit l'une des unités, soit une alimentation externe.

---

### MISE EN GARDE

---

L'entraînement démarre automatiquement après une interruption de la tension d'entrée si la commande de démarrage externe est active.

---

### MISE EN GARDE

---

Ne pas commander le moteur avec le dispositif de déconnexion ; à la place, utiliser les touches de marche et d'arrêt du tableau de contrôle ou les commandes du tableau des E/S de l'entraînement. Le nombre de cycles de charge maximum permis des condensateurs CC (c'est-à-dire les mises sous tension par application de puissance) est de cinq en dix minutes.

---

### MISE EN GARDE

---

#### **Fonctionnement incorrect de l'entraînement :**

- Si l'entraînement n'est pas mis en marche pendant une longue période, la performance de ses condensateurs électrolytiques sera réduite
- S'il est arrêté pour une période prolongée, le mettre en marche au moins tous les six mois pendant au moins 5 heures pour restaurer la performance des condensateurs, puis vérifier son fonctionnement. Il est recommandé de ne pas brancher l'entraînement directement sur la tension secteur. La tension doit être augmentée progressivement en utilisant une source CA réglable

#### **Le non-respect de ces instructions peut entraîner des blessures ou des dégâts matériels.**

Pour plus d'informations techniques, contacter l'usine ou le représentant commercial Eaton local.

## Chapter 1—PowerXL series overview

This chapter describes the purpose and contents of this manual, the receiving inspection recommendations and the PowerXL Series Open Drive catalog numbering system.

### How to use this manual

The purpose of this manual is to provide you with information necessary to install, set and customize parameters, start up, troubleshoot and maintain the Eaton PowerXL Series variable frequency drive (VFD). To provide for safe installation and operation of the equipment, read the safety guidelines at the beginning of this manual and follow the procedures outlined in the following chapters before connecting power to the PowerXL Series VFD. Keep this operating manual handy and distribute to all users, technicians and maintenance personnel for reference.

### Receiving and inspection

The PowerXL Series VFD has met a stringent series of factory quality requirements before shipment. It is possible that packaging or equipment damage may have occurred during shipment. After receiving your PowerXL Series VFD, please check for the following:

Check to make sure that the package includes the Instruction Leaflet Quick Start Guide, and accessory packet. The accessory packet includes:

- Rubber grommets
- Control cable grounding clamps
- Additional grounding screw

Inspect the unit to ensure it was not damaged during shipment.

Make sure that the part number indicated on the nameplate corresponds with the catalog number on your order.

If shipping damage has occurred, please contact and file a claim with the carrier involved immediately.

If the delivery does not correspond to your order, please contact your Eaton Electrical representative.

**Note:** Do not destroy the packing. The template printed on the protective cardboard can be used for marking the mounting points of the PowerXL VFD on the wall or in a cabinet.

### Real time clock battery activation

To activate the real time clock (RTC) functionality in the PowerXL Series VFD, the RTC battery (already mounted in the drive) must be connected to the control board.

Simply remove the primary drive cover, locate the RTC battery directly below the keypad, and connect the white 2-wire connector to the receptacle on the control board.

Figure 1. RTC battery connection.



Table 1. Common abbreviations.

Abbreviation	Definition
CT	Constant torque with high overload rating (150%)
VT	Variable torque with low overload rating (110%)
I <sub>H</sub>	High overload current (150%)
I <sub>L</sub>	Low overload current (110%)
VFD	Variable Frequency Drive
RTC	Real Time Clock

Rating label

Figure 2. Rating labels (samples).

230 V

<b>EATON</b> Powering Business Worldwide			
Cat. No.: DG1-32011FB-C21C			
Style No.: 9701-1001-00P			
Article No.: 9701-1001-00P			
PowerXL™ DG1 VFD		Factory ID: I	
CT/VT	Input	Output	
3HP/ +1P (2.2KW/ 3KW)	U (V~)	208-240 3Ø	0~Vin 3Ø
	F (Hz)	50/60 Hz	0-400 Hz
	I (A)	10.2/11.6	11/12.5
IE Class	IE2		
90/100 loss	2.0%		
Details	<a href="http://eaton.com/EcoDesign-VFD">http://eaton.com/EcoDesign-VFD</a>		
Enclosure Rating TYPE 1 / IP 21			
User installation manual: MN040002EN			
Serial No.: XXXXXXXXXX			
EAN: 4015081734047			
NAED: 78668586046			
Field installed conductors must be copper rated at 75°C			
YYMMDD	<a href="http://www.eaton.com">www.eaton.com</a>	Made In China	

480 V

<b>EATON</b> Powering Business Worldwide			
Cat. No.: DG1-343D3FB-C54C			
Style No.: 9702-1104-XXP			
Article No.: 9702-1104-XXP			
PowerXL™ DG1 VFD		Factory ID: I	
CT/VT	Input	Output	
1.1KW/ 1.5KW	U (V~)	380-440 3Ø	0~Vin 3Ø
	F (Hz)	50/60 Hz	0-400 Hz
	I (A)	3.1/4	3.3/4.3
1.5HP/ 2HP	U (V~)	440-500 3Ø	0~Vin 3Ø
	F (Hz)	50/60 Hz	0-400 Hz
	I (A)	2.8/3.2	3/3.4
IE Class	IE2		
90/100 loss	2.0%		
Details	<a href="http://eaton.com/EcoDesign-VFD">http://eaton.com/EcoDesign-VFD</a>		
Enclosure Rating TYPE 1 / IP 21			
User installation manual: MN040002EN			
Serial No.: XXXXXXXXXX			
EAN: 4015081710782			
NAED: 786685887760			
Field installed conductors must be copper rated at 75°C			
YYMMDD	<a href="http://www.eaton.com">www.eaton.com</a>	Made In China	

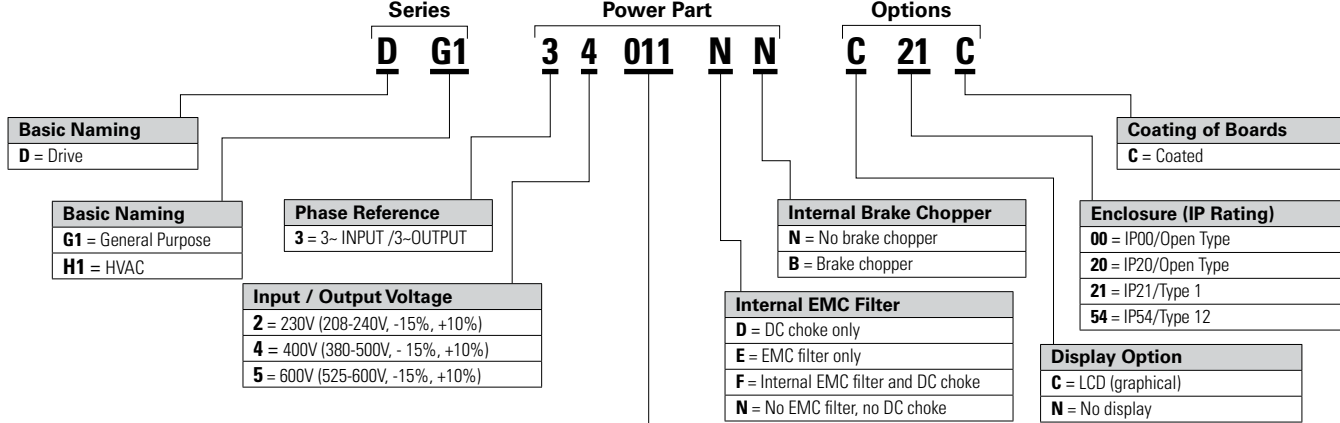
575 V

<b>EATON</b> Powering Business Worldwide			
Cat. No.: DG1-35460FN-C00C			
Style No.: 3-4918-303A			
Article No.: 3-4918-303A			
PowerXL™ TM DG1 VFD		Factory ID: W	
CT/VT	Input	Output	
336KW/ 373KW	U (V~)	525-600 3Ø	0~Vin 3Ø
	F (Hz)	50/60 Hz	0-320 Hz
	I (A)	532	460/520
450HP/ 500HP	U (V~)	525-600 3Ø	0~Vin 3Ø
	F (Hz)	50/60 Hz	0-320 Hz
	I (A)	532	460/520
IE Class	IE2		
90/100 loss	1.44%		
Details	<a href="http://eaton.com/EcoDesign-VFD">http://eaton.com/EcoDesign-VFD</a>		
Enclosure Rating UL Open Type / IP0			
User Installation Manual: MN0400035EN			
Serial No.: 1234567890			
NAED: 786687035527			
Field installed conductors must be copper rated at 75°C			
210806	<a href="http://www.eaton.com">www.eaton.com</a>	Assembled in USA	



Catalog number system

Figure 3. Catalog numbering system.



DG1 - Output Current Rating (CT)		
208-240V	380-500V	525-600V
3D7 =3.7 A, 0.55 kW, 0.75 hp	2D2 =2.2 A, 0.75 kW, 1 hp	3D3 =3.3 A, 1.5 kW, 2 hp
4D8 =4.8 A, 0.75 kW, 1 hp	3D3 =3.3 A, 1.1 kW, 1.5 hp	4D5 =4.5 A, 2.2 kW, 3 hp
6D6 =6.6 A, 1.1 kW, 1.5 hp	4D3 =4.3 A, 1.5 kW, 2 hp	7D5 =7.5 A, 3.7 kW, 5 hp
7D8 =7.8 A, 1.5 kW, 2 hp	5D6 =5.6 A, 2.2 kW, 3 hp	010 =10 A, 5.5 kW, 7.5 hp
011 =11 A, 2.2 kW, 3 hp	7D6 =7.6 A, 3 kW, 5 hp	013 =13.5 A, 7.5 kW, 10 hp
012 =12.5 A, 3 kW, 5 hp (VT)	9D0 =9 A, 4 kW, 7.5 hp (VT)	018 =18 A, 11 kW, 15 hp
017 =17.5 A, 3.7 kW, 5 hp	012 =12 A, 5.5 kW, 7.5 hp	022 =22 A, 15 kW, 20 hp
025 =25 A, 5.5 kW, 7.5 hp	016 =16 A, 7.5 kW, 10 hp	027 =27 A, 18.5 kW, 25 hp
031 =31 A, 7.5 kW, 10 hp	023 =23 A, 11 kW, 15 hp	034 =34 A, 22 kW, 30 hp
048 =48 A, 11 kW, 15 hp	031 =31 A, 15 kW, 20 hp	041 =41 A, 30 kW, 40 hp
061 =61 A, 15 kW, 20 hp	038 =38 A, 18.5 kW, 25 hp	052 =52 A, 37 kW, 50 hp
075 =75 A, 18.5 kW, 25 hp	046 =46 A, 22 kW, 30 hp	062 =62 A, 45 kW, 60 hp
088 =88 A, 22 kW, 30 hp	061 =61 A, 30 kW, 40 hp	080 =80 A, 55 kW, 75 hp
114 =114 A, 30 kW, 40 hp	072 =72 A, 37 kW, 50 hp	100 =100 A, 75 kW, 100 hp
143 =143 A, 37 kW, 50 hp	087 =87 A, 45 kW, 60 hp	125 =125 A, 90 kW, 125 hp
170 =170 A, 45 kW, 60 hp	105 =105 A, 55 kW, 75 hp	144 =144 A, 110 kW, 150 hp
211 =211 A, 55 kW, 75 hp	140 =140 A, 75 kW, 100 hp	208 =208 A, 132 kW, 200 hp
248 =248 A, 75 kW, 100 hp	170 =170 A, 90 kW, 125 hp	200 = 208 A, 200 kW, 200 hp
	205 =205 A, 110 kW, 150 hp	261 = 261 A, 250 kW, 250 hp
	245 =245 A, 132 kW, 200 hp	325 = 325 A, 315 kW, 300 hp
	310 = 310 A, 160 kW, 250 hp	385 = 385 A, 355 kW, 300 hp
	385 = 385 A, 200 kW, 300 hp	416 = 416 A, 400 kW, 400 hp
	460 = 460 A, 250 kW, 350 hp	460 = 460 A, 450 kW, 450 hp
	520 = 520 A, 250 kW, 450 hp	520 = 520 A, 500 kW, 500 hp
	590 = 590 A, 315 kW, 500 hp	590 = 590 A, 560 kW, 600 hp
	650 = 650 A, 355 kW, 500 hp	650 = 650 A, 630 kW, 650 hp
	730 = 730 A, 400 kW, 600 hp	820 = 820 A, 800 kW, 800 hp (VT)
	820 = 820 A, 450 kW, 700 hp	
	920 = 920 A, 500 kW, 800 hp	
	1K0 = 1180 A, 630 kW, 1000 hp (VT)	

## Power ratings and product selection

### PowerXL Series drives—208-230 Volt

Table 2. Type/IP20.

Frame size	Constant torque (CT)/high overload (I <sub>H</sub> )			Variable torque (VT)/low overload (I <sub>L</sub> )			DG1 Catalog number
	230 V, 50 Hz kW rating	230 V, 60 Hz hp	Current A	230 V, 50 Hz kW rating	230 V, 60 Hz hp	Current A	
FR0	0.55	0.75	3.7	0.75	1	4.8	DG1-323D7EB-C20C
	0.75	1	4.8	1.1	1.5	6.6	DG1-324D8EB-C20C
	1.1	1.5	6.6	1.5	2	7.8	DG1-326D6EB-C20C

Table 3. Type 1/IP21.

Frame size	Constant torque (CT)/high overload (I <sub>H</sub> )			Variable torque (VT)/low overload (I <sub>L</sub> )			Catalog number
	230 V, 50 Hz kW rating	230 V, 60 Hz hp	Current A	230 V, 50 Hz kW rating	230 V, 60 Hz hp	Current A	
FR1	0.55	0.75	3.7	0.75	1	4.8	DG1-323D7FB-C21C
	0.75	1	4.8	1.1	1.5	6.6	DG1-324D8FB-C21C
	1.1	1.5	6.6	1.5	2	7.8	DG1-326D6FB-C21C
	1.5	2	7.8	2.2	3	11	DG1-327D8FB-C21C
	2.2	3	11	3	—	12.5	DG1-32011FB-C21C
FR2	3	—	12.5	3.7	5	17.5	DG1-32012FB-C21C
	3.7	5	17.5	5.5	7.5	25	DG1-32017FB-C21C
	5.5	7.5	25	7.5	10	31	DG1-32025FB-C21C
FR3	7.5	10	31	11	15	48	DG1-32031FB-C21C
	11	15	48	15	20	61	DG1-32048FB-C21C
FR4	15	20	61	18.5	25	75	DG1-32061FN-C21C
	18.5	25	75	22	30	88	DG1-32075FN-C21C
	22	30	88	30	40	114	DG1-32088FN-C21C
FR5	30	40	114	37	50	143	DG1-32114FN-C21C
	37	50	143	45	60	170	DG1-32143FN-C21C
	45	60	170	55	75	211	DG1-32170FN-C21C
FR6	55	75	211	75	100	261	DG1-32211FN-C21C
	75	100	248	90	125	312	DG1-32248FN-C21C

Table 4. Type 12/IP54.

Frame size	Constant torque (CT)/high overload (I <sub>H</sub> )			Variable torque (VT)/low overload (I <sub>L</sub> )			Catalog number
	230 V, 50 Hz kW rating	230 V, 60 Hz hp	Current A	230 V, 50 Hz kW rating	230 V, 60 Hz hp	Current A	
FR1	0.55	0.75	3.7	0.75	1	4.8	DG1-323D7FB-C54C
	0.75	1	4.8	1.1	1.5	6.6	DG1-324D8FB-C54C
	1.1	1.5	6.6	1.5	2	7.8	DG1-326D6FB-C54C
	1.5	2	7.8	2.2	3	11	DG1-327D8FB-C54C
	2.2	3	11	3	—	12.5	DG1-32011FB-C54C
FR2	3	—	12.5	3.7	5	17.5	DG1-32012FB-C54C
	3.7	5	17.5	5.5	7.5	25	DG1-32017FB-C54C
	5.5	7.5	25	7.5	10	31	DG1-32025FB-C54C
FR3	7.5	10	31	11	15	48	DG1-32031FB-C54C
	11	15	48	15	20	61	DG1-32048FB-C54C
FR4	15	20	61	18.5	25	75	DG1-32061FN-C54C
	18.5	25	75	22	30	88	DG1-32075FN-C54C
	22	30	88	30	40	114	DG1-32088FN-C54C
FR5	30	40	114	37	50	143	DG1-32114FN-C54C
	37	50	143	45	60	170	DG1-32143FN-C54C
	45	60	170	55	75	211	DG1-32170FN-C54C
FR6	55	75	211	75	100	261	DG1-32211FN-C54C
	75	100	248	90	125	312	DG1-32248FN-C54C

## PowerXL Series drives—380-500 Volt

Table 5. Type/IP20.

Frame size	Constant torque (CT)/high overload ( $I_H$ )			Variable torque (VT)/low overload ( $I_L$ )			DG1 Catalog number
	400 V, 50 Hz kW rating	460 V, 60 Hz hp	Current A	400 V, 50 Hz kW rating	460 V, 60 Hz hp	Current A	
FR0	0.75	1	2.2	1.1	1.5	3.3	DG1-342D2EB-C20C
	1.1	1.5	3.3	1.5	2	4.6	DG1-343D3EB-C20C
	1.5	2	4.3	2.2	3	5.6	DG1-344D3EB-C20C
	2.2	3	5.6	3	5	7.6	DG1-345D6EB-C20C

Table 6. Type 1/IP21.

Frame size	Constant torque (CT)/high overload ( $I_H$ )			Variable torque (VT)/low overload ( $I_L$ )			Catalog number
	400 V, 50 Hz kW rating	460 V, 60 Hz hp	Current A	400 V, 50 Hz kW rating	460 V, 60 Hz hp	Current A	
FR1	0.75	1	2.2	1.1	1.5	3.3	DG1-342D2FB-C21C
	1.1	1.5	3.3	1.5	2	4.3	DG1-343D3FB-C21C
	1.5	2	4.3	2.2	3	5.6	DG1-344D3FB-C21C
	2.2	3	5.6	3	5	7.6	DG1-345D6FB-C21C
	3	5	7.6	4	–	9	DG1-347D6FB-C21C
	4	–	9	5.5	7.5	12	DG1-349D0FB-C21C
FR2	5.5	7.5	12	7.5	10	16	DG1-34012FB-C21C
	7.5	10	16	11	15	23	DG1-34016FB-C21C
	11	15	23	15	20	31	DG1-34023FB-C21C
FR3	15	20	31	18.5	25	38	DG1-34031FB-C21C
	18.5	25	38	22	30	46	DG1-34038FB-C21C
	22	30	46	30	40	61	DG1-34046FB-C21C
FR4	30	40	61	37	50	72	DG1-34061FN-C21C
	37	50	72	45	60	87	DG1-34072FN-C21C
	45	60	87	55	75	105	DG1-34087FN-C21C
FR5	55	75	105	75	100	140	DG1-34105FN-C21C
	75	100	140	90	125	170	DG1-34140FN-C21C
	90	125	170	110	150	205	DG1-34170FN-C21C
FR6	110	150	205	132	200	261	DG1-34205FN-C21C
	150	200	245	160	250	310	DG1-34245FN-C21C

**Table 7. Type 12/IP54.**

Frame size	Constant torque (CT)/high overload (I <sub>H</sub> )			Variable torque (VT)/low overload (I <sub>L</sub> )			Catalog number
	400 V, 50 Hz kW rating	460 V, 60 Hz hp	Current A	400 V, 50 Hz kW rating	460 V, 60 Hz hp	Current A	
FR1	0.75	1	2.2	1.1	1.5	3.3	DG1-342D2FB-C54C
	1.1	1.5	3.3	1.5	2	4.3	DG1-343D3FB-C54C
	1.5	2	4.3	2.2	3	5.6	DG1-344D3FB-C54C
	2.2	3	5.6	3	5	7.6	DG1-345D6FB-C54C
	3	5	7.6	4	–	9	DG1-347D6FB-C54C
	4	–	9	5.5	7.5	12	DG1-349D0FB-C54C
FR2	5.5	7.5	12	7.5	10	16	DG1-34012FB-C54C
	7.5	10	16	11	15	23	DG1-34016FB-C54C
	11	15	23	15	20	31	DG1-34023FB-C54C
FR3	15	20	31	18.5	25	38	DG1-34031FB-C54C
	18.5	25	38	22	30	46	DG1-34038FB-C54C
	22	30	46	30	40	61	DG1-34046FB-C54C
FR4	30	40	61	37	50	72	DG1-34061FN-C54C
	37	50	72	45	60	87	DG1-34072FN-C54C
	45	60	87	55	75	105	DG1-34087FN-C54C
FR5	55	75	105	75	100	140	DG1-34105FN-C54C
	75	100	140	90	125	170	DG1-34140FN-C54C
	90	125	170	110	150	205	DG1-34170FN-C54C
FR6	110	150	205	132	200	261	DG1-34205FN-C54C
	150	200	245	160	250	310	DG1-34245FN-C54C

**PowerXL Series drives—380, 500 Volt**

**Table 8. Type 0/IP00.**

Frame size	Constant torque (CT)/high overload (I <sub>H</sub> )			Variable torque (VT)/low overload (I <sub>L</sub> )			Catalog number
	400 V, 50 Hz kW rating	480 V, 60 Hz hp	Current A	400 V, 50 Hz kW rating	480 V, 60 Hz hp	Current A	
FR7	160	250	311	200	300	385	DG1-34310FN-C00C
	200	300	385	250	350	460	DG1-34385FN-C00C
	250	350	460	250	450	520	DG1-34460FN-C00C
	250	450	520	315	500	590	DG1-34520FN-C00C
FR8	315	500	590	355	500	650	DG1-34590FN-C00C
	355	500	650	400	600	730	DG1-34650FN-C00C
	400	600	730	450	700	820	DG1-34730FN-C00C
	450	700	820	500	800	920	DG1-34820FN-C00C
	500	800	920	560	900	1040	DG1-34920FN-C00C
	500	800	920	630	1000	1180	DG1-341K0FN-C00C

## PowerXL Series Drives—600 volt ①

Table 9. Type 1/IP21.

Frame size	Constant torque (CT)/high overload ( $I_H$ )			Variable torque (VT)/low overload ( $I_L$ )			Catalog number
	600 V, 60 Hz kW rating	600 V, 60 Hz hp	Current A	600 V, 60 Hz kW rating	600 V, 60 Hz hp	Current A	
FR1	1.5	2	3.3	2.2	3	4.5	DG1-353D3FB-C21C
	2.2	3	4.5	3.7	5	7.5	DG1-354D5FB-C21C
	3.7	5	7.5	5.5	7.5	10	DG1-357D5FB-C21C
FR2	5.5	7.5	10	7.5	10	13.5	DG1-35010FB-C21C
	7.5	10	13.5	11	15	18	DG1-35013FB-C21C
	11	15	18	15	20	22	DG1-35018FB-C21C
FR3	15	20	22	18.5	25	27	DG1-35022FB-C21C
	18.5	25	27	22	30	34	DG1-35027FB-C21C
	22	30	34	30	40	41	DG1-35034FB-C21C
FR4	30	40	41	37	50	52	DG1-35041FN-C21C
	37	50	52	45	60	62	DG1-35052FN-C21C
	45	60	62	55	75	80	DG1-35062FN-C21C
FR5	55	75	80	75	100	100	DG1-35080FN-C21C
	75	100	100	90	125	125	DG1-35100FN-C21C
	90	125	125	110	150	144	DG1-35125FN-C21C
FR6	110	150	144	150	200	208	DG1-35144FN-C21C
	150	200	208	187	250	250	DG1-35208FN-C21C

Table 10. Type 12/IP54.

Frame size	Constant torque (CT)/high overload ( $I_H$ )			Variable torque (VT)/low overload ( $I_L$ )			Catalog number
	600 V, 60 Hz kW rating	600 V, 60 Hz hp	Current A	600 V, 60 Hz kW rating	600 V, 60 Hz hp	Current A	
FR1	1.5	2	3.3	2.2	3	4.5	DG1-353D3FB-C54C
	2.2	3	4.5	3.7	5	7.5	DG1-354D5FB-C54C
	3.7	5	7.5	5.5	7.5	10	DG1-357D5FB-C54C
FR2	5.5	7.5	10	7.5	10	13.5	DG1-35010FB-C54C
	7.5	10	13.5	11	15	18	DG1-35013FB-C54C
	11	15	18	15	20	22	DG1-35018FB-C54C
FR3	15	20	22	18.5	25	27	DG1-35022FB-C54C
	18.5	25	27	22	30	34	DG1-35027FB-C54C
	22	30	34	30	40	41	DG1-35034FB-C54C
FR4	30	40	41	37	50	52	DG1-35041FN-C54C
	37	50	52	45	60	62	DG1-35052FN-C54C
	45	60	62	55	75	80	DG1-35062FN-C54C
FR5	55	75	80	75	100	100	DG1-35080FN-C54C
	75	100	100	90	125	125	DG1-35100FN-C54C
	90	125	125	110	150	144	DG1-35125FN-C54C
FR6	110	150	144	150	200	208	DG1-35144FN-C54C
	150	200	208	187	250	250	DG1-35208FN-C54C

**PowerXL Series drives—525—600 Volt**

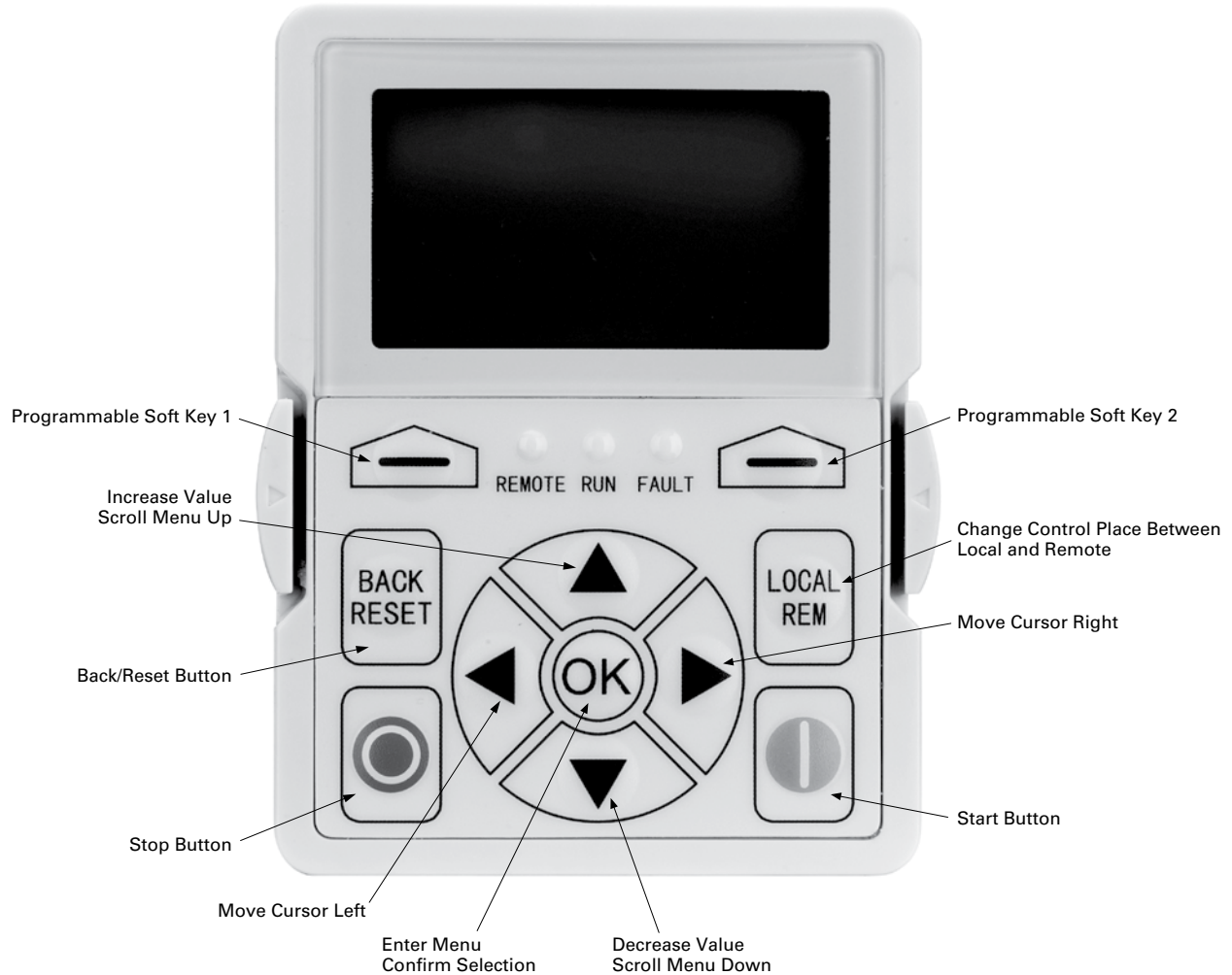
**Table 11. Type 0/IP00.**

Frame size	Constant torque (CT)/high overload ( $I_h$ )			Variable torque (VT)/low overload ( $I_L$ )			Catalog number
	600 V, 50 Hz kW rating	600 V, 60 Hz hp	Current A	600 V, 50 Hz kW rating	600 V, 60 Hz hp	Current A	
FR7	187	250	261	224	300	325	<b>DG1-35261FN-C00C</b>
	224	300	325	298	400	385	<b>DG1-35325FN-C00C</b>
	224	300	385	336	450	416	<b>DG1-35385FN-C00C</b>
FR8	298	400	416	336	450	460	<b>DG1-35416FN-C00C</b>
	336	450	460	373	500	520	<b>DG1-35460FN-C00C</b>
	373	500	520	448	600	590	<b>DG1-35520FN-C00C</b>
	448	600	590	485	650	650	<b>DG1-35590FN-C00C</b>
	485	650	650	522	700	750	<b>DG1-35650FN-C00C</b>
	485	650	650	597	800	820	<b>DG1-35820FN-C00C</b>

## Chapter 2—Keypad overview

The keypad is the interface between the drive and the user. It features an LCD display, 3 LED lights and 11 buttons. With the control keypad, it is possible to control the speed of a motor, to supervise the state of the equipment and to set the frequency converter's parameters. See **Figure 4**.

**Figure 4. Keypad and display.**



## Keypad buttons

### Buttons description

Table 12. Keypad buttons.




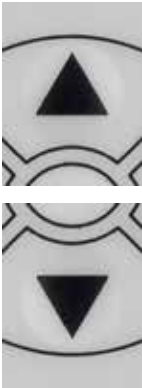





Icon	Button	Description
	Soft key 1, Soft key 2	<p><b>Soft key 1, soft key 2:</b> The functions of these two buttons shall be the following:</p> <ul style="list-style-type: none"> <li>• Forward/Reverse, this shall change motor's run direction.</li> <li>• Menu, this shall return to main menu.</li> <li>• Details, this shall display the details of the fault.</li> <li>• Bypass, this shall make drive go into bypass.</li> <li>• Jog, this shall activate jog. Jog can enabled via press OK Key and Soft2 Key (When the Soft2Key is Jog) and disabled via release any one of the two keys.</li> <li>• Favorite, this shall add this parameter to the Favorite menu.</li> <li>• Delete, this shall delete this parameter from the Favorite menu.</li> </ul>
	Back/Reset	<p><b>Back/Reset:</b> This button has three integrated functions. The button operates as backward button during normal mode. In edit mode, it is used as cancel operate. It is also used to reset faults when faults occur.</p> <ul style="list-style-type: none"> <li>• Backs up one step.</li> <li>• Cancels Modify in edit mode.</li> <li>• Resets the active faults (all the active faults shall be reset by pressing this button more than 2 seconds in any page).</li> <li>• Hold Stop and Back Reset for 5 seconds to return drive to factory default.</li> <li>• At Main Menu page by hitting Back/Reset takes to Default Page.</li> </ul>
	Local/Remote	<p><b>Local/Remote:</b> Switches between LOCAL and REMOTE control for start and speed reference. The control locations corresponding to local and remote shall be selected within an application.</p>
	Up Down	<p><b>Up and down arrows:</b></p> <ul style="list-style-type: none"> <li>• Move either up or down a menu list to select the desired menu item.</li> <li>• Editing a parameter bit by bit, while the active digit is scrolled.</li> <li>• Increase/decrease the reference value of the selected parameter.</li> <li>• In parameter comparison mode, scroll through the parameters of which current value is different from comparison parameter value.</li> <li>• In parameter page when in read mode, move to the previous or next brother parameter of this parameter.</li> </ul>






Table 12. Keypad buttons, continued.

Icon	Button	Description
	Left	<p><b>Left arrow:</b></p> <ul style="list-style-type: none"> <li>• Navigation button, movement to left when editing a parameter digit by digit.</li> <li>• Backs up one step.</li> <li>• At Main Menu page by hitting Back/Reset takes to Default Page.</li> </ul>
	Right	<p><b>Right arrow:</b></p> <ul style="list-style-type: none"> <li>• Enter parameter group mode.</li> <li>• Enter parameter mode from group mode.</li> <li>• Enter parameter whole edit mode when this parameter can be written.</li> <li>• Enter parameter bit by bit edit mode from whole edit mode.</li> <li>• Navigation button, movement to right when editing a parameter bit by bit.</li> </ul>
	OK	<p><b>OK:</b></p> <ul style="list-style-type: none"> <li>• Will clear all the fault history if pressed for more than 5 seconds (including 5 seconds) in any page.</li> <li>• This button is used in the parameter edit mode to save the parameter setting.</li> <li>• To confirm the start-up list at the end of the Start-Up Wizard.</li> <li>• To confirm the comparison item in parameters comparison mode.</li> </ul> <p>The following is the same with Right key:</p> <ul style="list-style-type: none"> <li>• Enter parameter whole edit mode when this parameter can be written.</li> <li>• Enter parameter group mode.</li> <li>• Enter parameter mode from group mode.</li> </ul>
	Stop	<p><b>Stop:</b></p> <p>This button operates as the motor stop button for normal operation. The default is for this button to always be active. It can be changed in parameter P7.5 to only when “Keypad” is selected as the control source.</p> <ul style="list-style-type: none"> <li>• Motor stop from the keypad.</li> </ul>
	Start	<p><b>Start:</b></p> <p>This button operates as motor start button for normal operation when the “Keypad” is selected as the active control source. When Keypad is the reference place after hitting the start button, it will jump directly to the Keypad Ref Screen.</p>

## LED lights

**Table 13. LED state indicators.**

Indicator	Description
 Run	<b>Run:</b> Indicates that the VFD is running and controlling the load in Drive or Bypass. Blinks when a stop command has been given but the drive is still ramping down.
 Fault	<b>Fault:</b> Turn on when there is one or more active drive fault(s).
 Remote	<b>Local/Remote:</b> Local: If the local control place is selected, the light will be off. Remote: If the remote control place is selected, the light will be on.

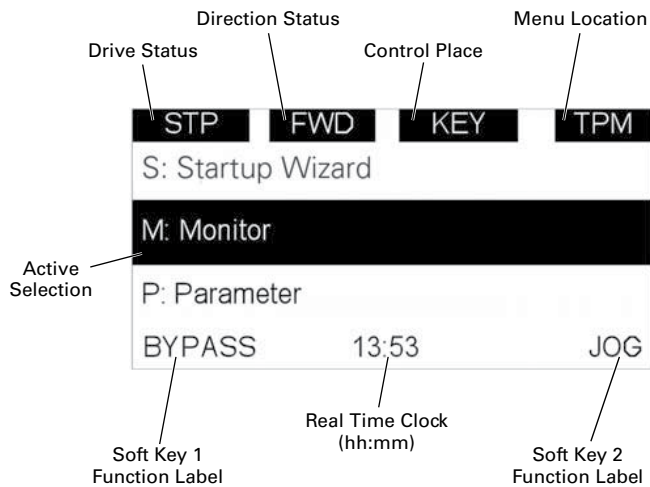
## LCD display

The keypad LCD indicates the status of the motor and the drive and any faults in motor or drive functions. On the LCD, the user sees information about the current location in the menu structure and the item displayed.

### Overview

Five lines shall be displayed in the screen. General view is as following in **Figure 5**.

**Figure 5. General view of LCD.**



The lines definition is as below:

The first line is State line, shows:

- **RUN/STP/NRD/FIM/TFM**—If motor is running, the run state shall display “RUN”; otherwise the state display “STP.” “RUN” blinks when the stop command is sent but the drive is decelerating. “NRD” is displayed if the drive is not ready or does not have a signal “FIM” is displayed to indicate it is in Fire Mode and the drive is in a Run state. “TFM” is displayed when in the Fire Mode Test Mode and the drive is in a Run State.
- **FWD/REV/JOG**—If the motor running direction is clockwise, display “FWD”; otherwise display “REV.” “Jog” if the drive is in Jog mode the status indication will occur.
- **KEY/I/O/BPS/RBP/BUS/OFF**—If it is in bypass currently, display “BPS”; when run command is given it will got to “RBP” otherwise, if the current control source is I/O terminal, display “I/O.” If it is keypad, then display “KEY”; otherwise display “BUS.” if HOA enabled and switch to OFF, it shall show OFF.
- **PAR/MON/FLT/OPE/QSW/FAV/TPM/MS1/SL1/SL2/SL3/SL4/BUx**.—If the current page is parameter menu, display “PAR”; If monitor menu, then display “MON”; If fault menu, then display “FLT”; If operation menu, then display “OPE”; If quick start wizard, then display “QSW”; If optional card menu, then display “BOA”; If favorite menu, then display “FAV”; If main menu, then display “TPM” when doing the Multi-drive Pump and Fan mode, the drive mode will be defined with MS- Master and SL being a slave drive. The 1 through 4 will indicate the number in the series it is. “BUx” indicates the drive being a backup drive when in the redundant drive system.

The second line is Code line, shows the menu code.

The third line is Name line, shows the menu name or parameters name.

The fourth line is Value line, shows the submenu name or parameters value.

The fifth line is Soft key line, the functions of Soft key 1 and Soft key 2 are changeable, and the real time is in the middle.

### Welcome page

LCD shall show the welcome page when power on. See **Figure 6**.

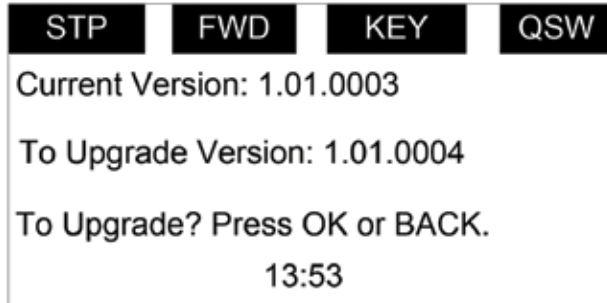
**Figure 6. Welcome page.**



**Upgrade page**

After welcome page, keypad will check whether there is different keypad firmware version in MCU’s serial flash. If yes, then ask user whether to upgrade the keypad.

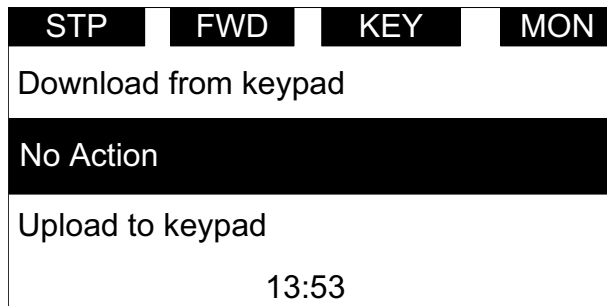
**Figure 7. Upgrade page.**



**Auto backup page**

If keypad is plugged into a new drive, then auto backup page will be shown to notice the user whether to do the upload/download.

**Figure 8. Auto backup page.**



**Soft key description**

There are two soft key buttons. They have different definitions under different pages.

**Table 14. Soft keys.**

Keypad Display page	Default Soft key 1	Default Soft key 2
Main menu page	Null or bypass	Jog*
Group node page	Reverse or forward*	Menu
Parameter node page	Null or favorite	Menu
Favorite page	Delete	Menu
Fault page	Detail	Menu

**\*Note:** If P21.1.18 or P21.1.19 is set to hidden it will hide this value.

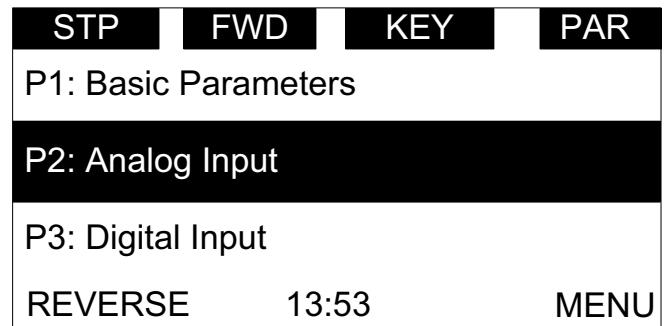
1. In the main menu (root node), “JOG” shall be shown on the right. If bypass is enabled, then “BYPASS” shall be shown on the left. Otherwise, it will not be shown. See **Figure 9**

**Figure 9. Main menu.**



2. For the parameter group, the two soft keys “REVERSE/ FORWARD” and “MENU” shall be shown. See **Figure 10**

**Figure 10. Parent node page.**



## Chapter 2—Keypad overview

- For the parameter menu, if this parameter hasn't been added into the favorite list, two soft keys "FAVORITE" and "MENU" shall be shown. If it has been added into the favorite list, only one soft key "MENU" is shown in the right.

**Figure 11. Parameter page.**

STP	FWD	KEY	PAR
P2.3.1			
AI2 Mode			
0 - 20mA			
FAVORITE	13:53	MENU	

- If one parameter has been added to the favorite list, it shall appear in the favorite menu. Then when you enter into the favorite menu, two soft keys "DELETE" and "MENU" shall be shown, and "DELETE" means you can delete the selected parameter from favorite list. See **Figure 12**

**Figure 12. Parameter page from favorite menu.**

STP	FWD	KEY	PAR
P2.3.1: AI2 Mode			
M2: Reference Frequency			
M3: Motor Speed			
DELETE	13:53	MENU	

- For the fault group, two soft keys "DETAIL" and "MENU" shall be shown. See **Figure 13**. For more information, see **Page 16**

**Figure 13. Fault page.**

STP	FWD	KEY	FLT
F1.2: Fault			
Over Voltage			
2012-4-8 12:30:45			
DETAIL	13:53	MENU	

# Chapter 3—Menu overview

## Main menu page

The data on the keypad are arranged in menus and sub-menus. The first menu level consists of M, P, F, B, T, O and S, and it is called the Main menu.

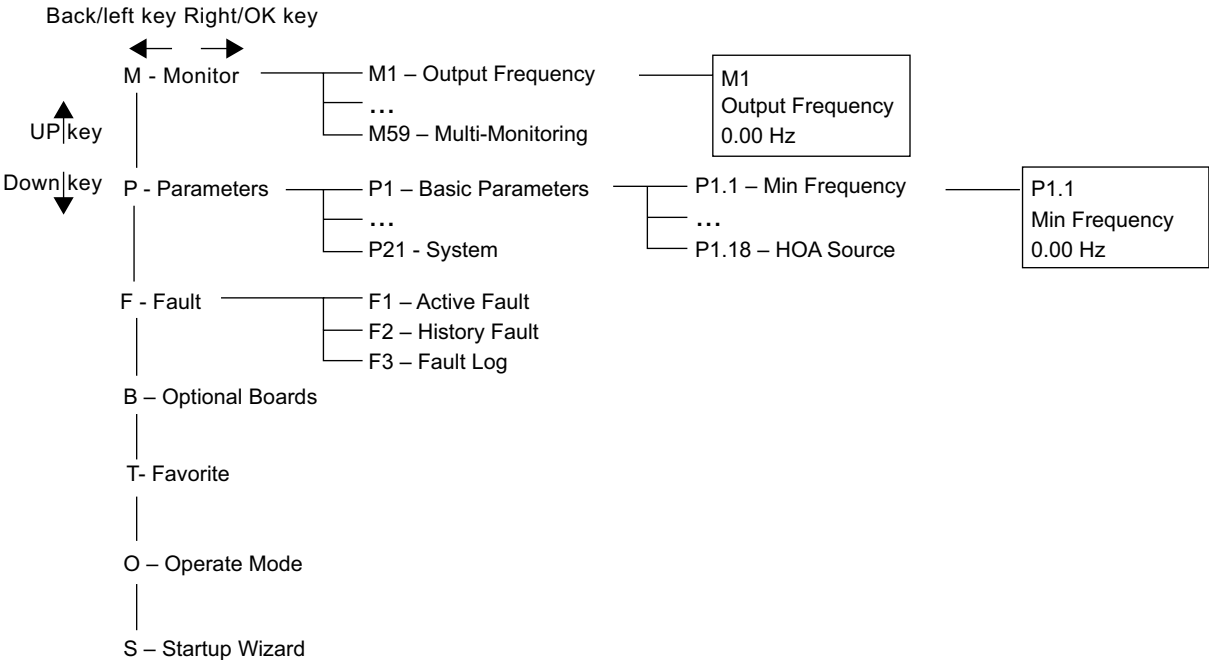
Figure 14. Main menu page.



## Menu navigation

This section provides basic instruction on navigating each section in the menu structure.

Figure 15. Main menu navigation.



**Menu structure**

**Table 15. Keypad menus.**

<b>Item</b>	<b>Description</b>		<b>Item</b>	<b>Description</b>	<b>Item</b>	<b>Description</b>
Monitor	M1—Output Frequency	M31—PID1 Feedback	Parameters	P1—Basic Parameters	Fault	F1—Active Fault
	M2—Freq Reference	M32—PID1 Error Value		P2—Analog Input		F2—History Fault
	M3—Motor Speed	M33—PID1 Output		P3—Digital Input		F3—Fault Log
	M5—Motor Torque	M35—PID2 Set Point		P5—Digital Output	Optional Boards	Bx—SlotA/SlotB
	M6—Motor Power	M36—PID2 Feedback		P6—Logic Function	Favorite	—
	M7—Motor Voltage	M37—PID2 Error Value		P7—Drive Control	Operate Mode	O1—Output Frequency
	M8—DC-link Voltage	M38—PID2 Output		P8—Motor Control		O2—Freq Reference
	M9—Unit Temperature	M39—PID2 Status		P9—Protections		O3—Motor Speed
	M10—Motor Temperature	M40—Running Motors		P10—PID Controller1		O4—Motor Current
	M11—Torque Reference	M41—PT100 Temp		P11—PID Controller2		O5—Motor Torque
	M12—Analog Input 1	M42—Last Active Fault		P12—Preset Speed		O6—Motor Power
	M13—Analog Input 2	M43—RTC Battery Status		P13—Torque Control		O7—Motor Voltage
	M14—Analog Output 1	M44—Instance Motor Power		P14—Brake		O8—DC-Link Voltage
	M15—Analog Output 2	M45—Energy Savings		P15—Fire Mode		O9—Unit Temperature
	M16—DI1, DI2, DI3	M46—Control Board DIDO Status		P16—Second Motor Para		O10—Motor Temperature
	M17—DI4, DI5, DI6	M47—SlotA DIDO Status		P17—Bypass		R11—Keypad Torque Ref
	M18—DI7, DI8	M48—SlotB DIDO Status		P18—Pump Parameters		R12—Keypad Reference
	M19—DO1, Virtual RO1, Virtual RO2	M49—Application Status Word		P19—Real Time Clock		R13—PID1 Keypad Setpoint 1
	M20—RO1, RO2, RO3	M50—Standard Status Word		P20—Communication		R14—PID1 Keypad Setpoint 2
	M21—TC1, TC2, TC3	M51—Output		P21—System	Startup Wizard	S—Startup Wizard
	M22—Interval 1	M52—Reference				
	M23—Interval 2	M53—Total MWh Count				
	M24—Interval 3	M54—Total Power Day Count				
	M25—Interval 4	M55—Total Power Hr Count				
	M26—Interval 5	M56—Trip MWh Count				
	M27—Timer 1	M57—Trip Power Day Count				
	M28—Timer 2	M58—Trip Power Hr Count				
	M29—Timer 3	M59—Multi-Monitoring				
	M30—PID1 Set Point					

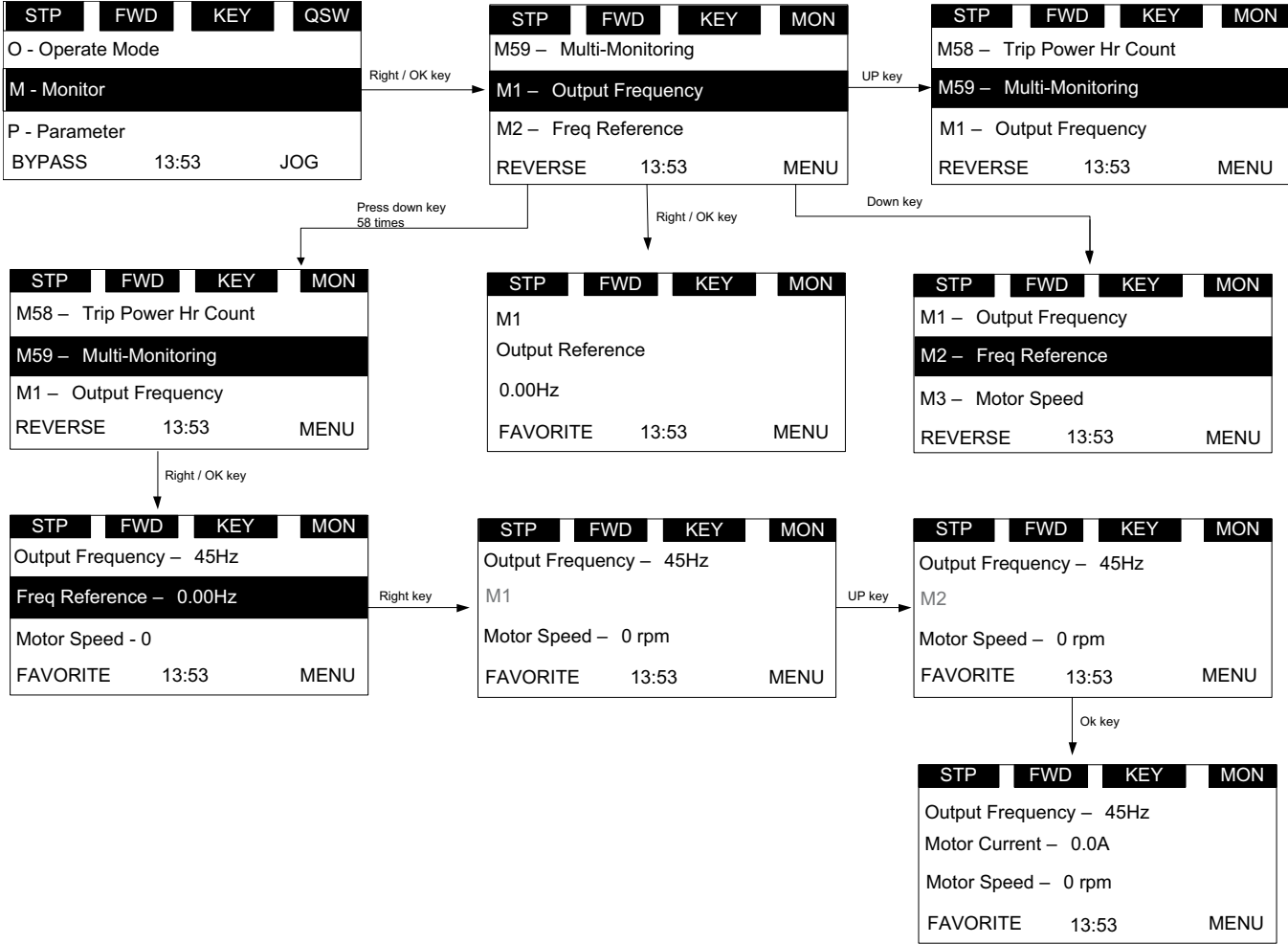
**Note:** Will vary depending on application selected.

**M—Monitor**

In monitor page, user shall not be able to edit the parameters except multi-monitor parameter. Multi-monitor parameters allow for displaying 3 monitor values on display. The three values can be changed to any of the listed values.

The navigation for monitor is as **Figure 16**.

**Figure 16. M—Monitor.**



## Chapter 3—Menu overview

### F—Fault

There are four fault pages. The first one is F1 active faults; the second one will pop-up automatically when fault occurs; the third one is F2 fault history, and the fourth one is the fault log page

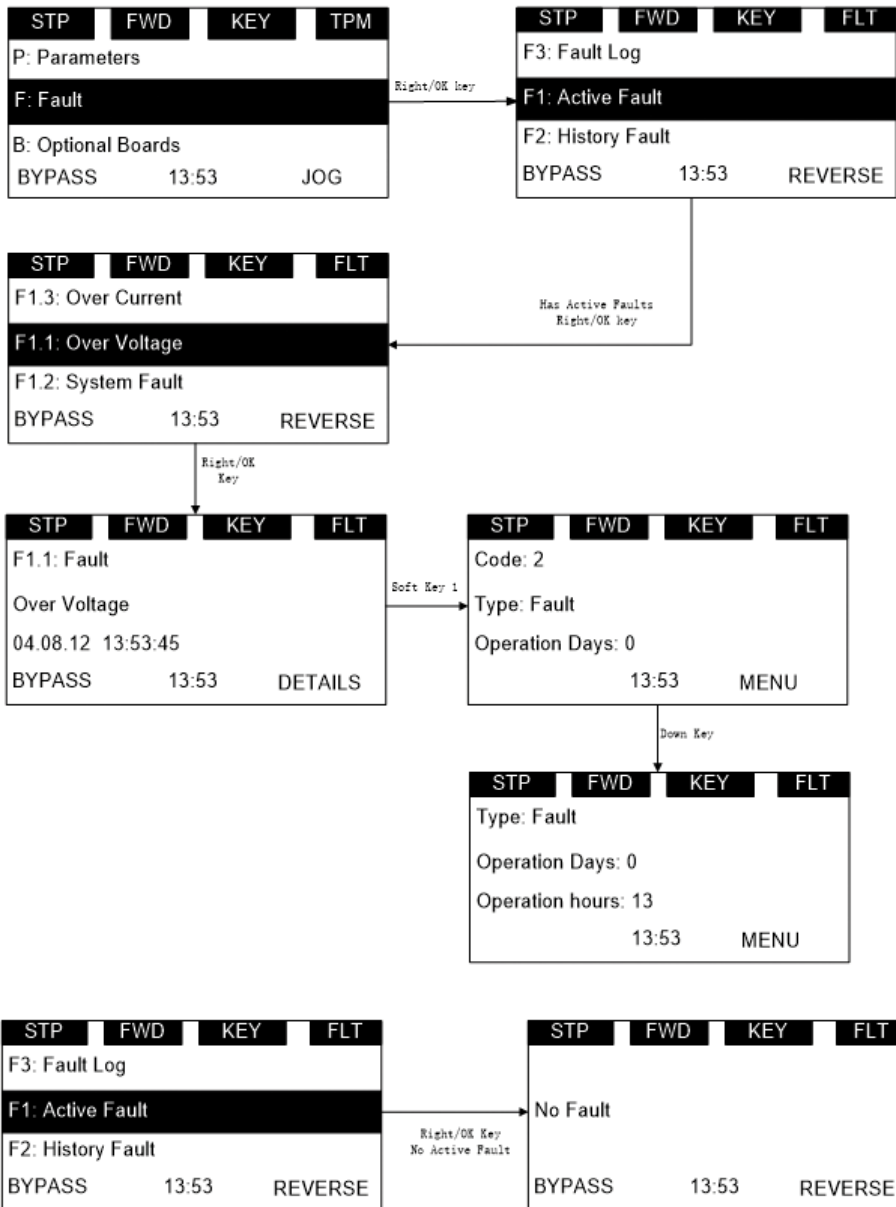
If there is no active fault/history fault, then “No fault” shall be shown.

#### Active fault

The navigation for active faults is as **Figure 17**.

After the DETAIL soft key is pressed, the following detail information about the fault shall be shown: fault code, type, power day count, power hour count, frequency, current, voltage, power, torque, DC voltage, unit temperature, run status, direction, warning, zero speed, Mwh count, at reference.

**Figure 17. Active faults.**

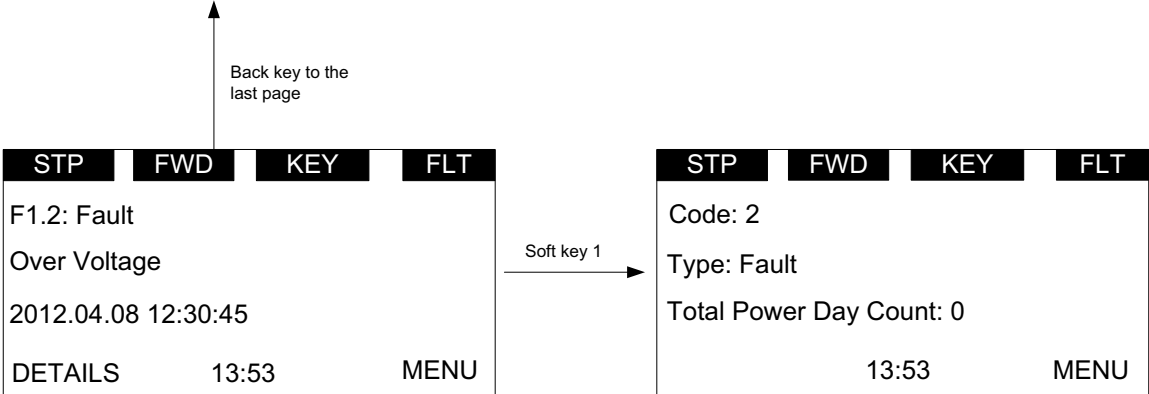




**Pop-up fault**

The navigation for the pop-up active fault is as **Figure 18**.

**Figure 18. Pop-up active faults.**



The latest active fault page shall pop up when there is a new active fault, the pop-up fault page is the same as the active fault page.

Pressing the back/reset key less than 2 seconds shall back to the last page user is watching.

Pressing the back/reset key more than 2 seconds shall reset all active faults when all the active fault condition is not satisfied.

User shall be able to navigate all the active faults by up/down key.

The page for active faults and pop-up faults are the same, except one: the response to the "Back" key. In active faults page, if the Back key is pressed, it returns to the last level menu. In pop-up faults page, it returns to the last page.

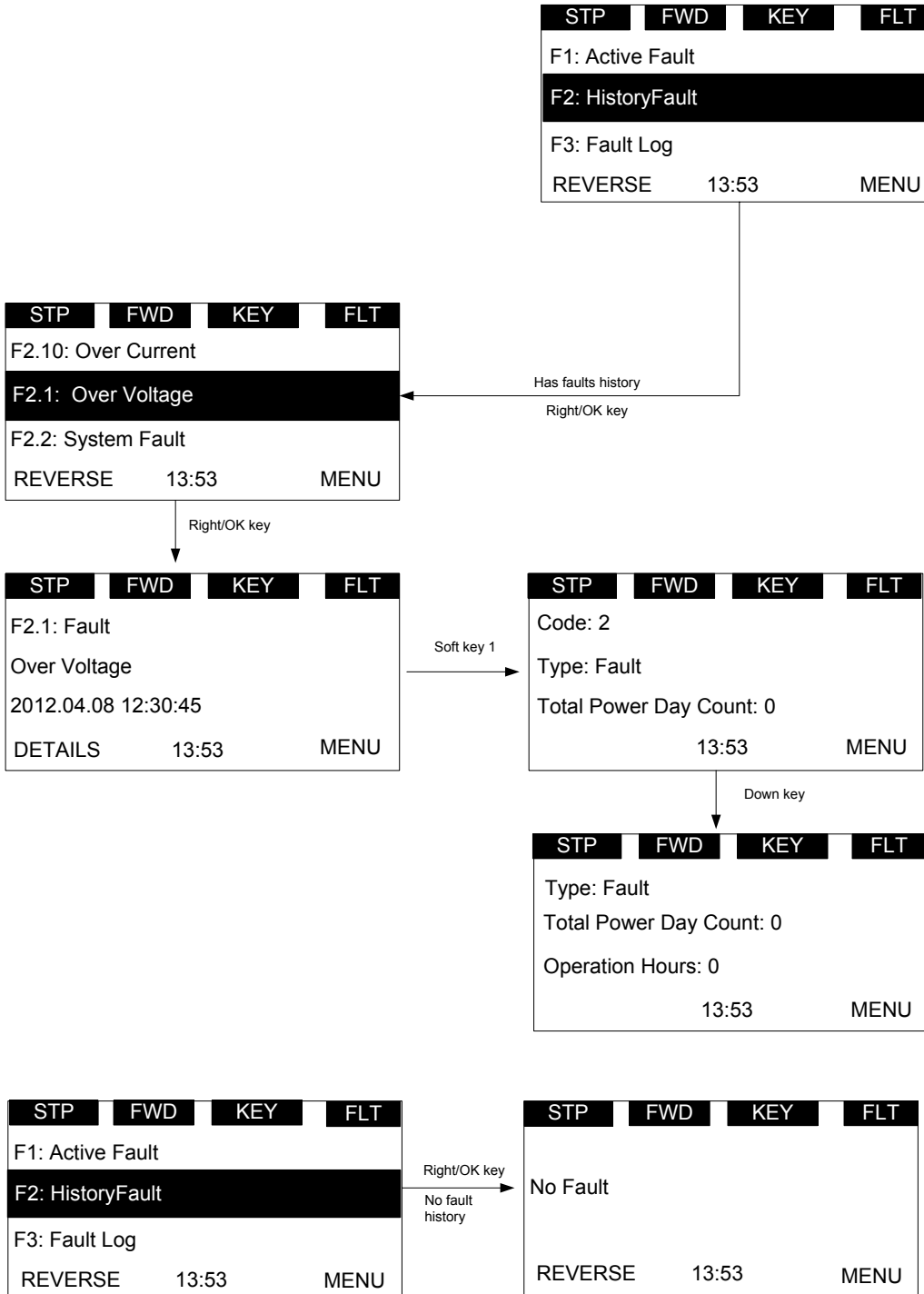
## Chapter 3—Menu overview

### Fault history

The navigation for fault history is as **Figure 19**.

In any page, OK button is used to clear all the active faults and fault history by pressing more than 5s without password.

**Figure 19. Fault history.**



**Fault Log**

The Fault Log will store the last 50 faults in it with 1 being the most recent and 50 being the oldest. Only the fault code, name and time stamp are stored with these faults.

**P—Parameter**

The navigation for the parameter menu is shown in **Figure 20**.

In parameter page, the parameter code shall be shown in the second line (such as P1.1).

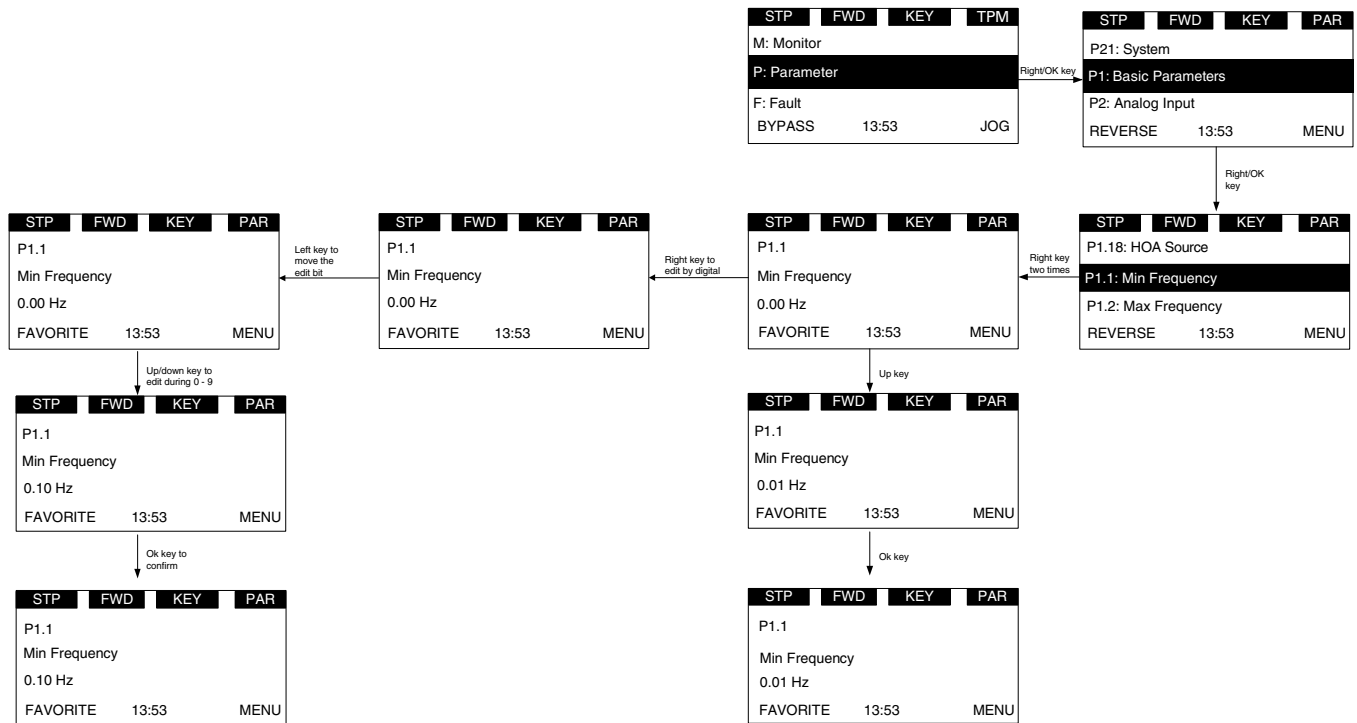
In parameter page, the parameter name shall be shown in the third line (such as Min Frequency).

In parameter page, the value of parameter and unit shall be shown in the fourth line (0.00 Hz).

If the parameter is read and write, then pressing the right key shall make the parameter value flash, which means that the value can be edited.

If the parameter is read only, then pressing the right key will not have any effect, which means that the value can not be edited.

**Figure 20. Parameter menu overview.**



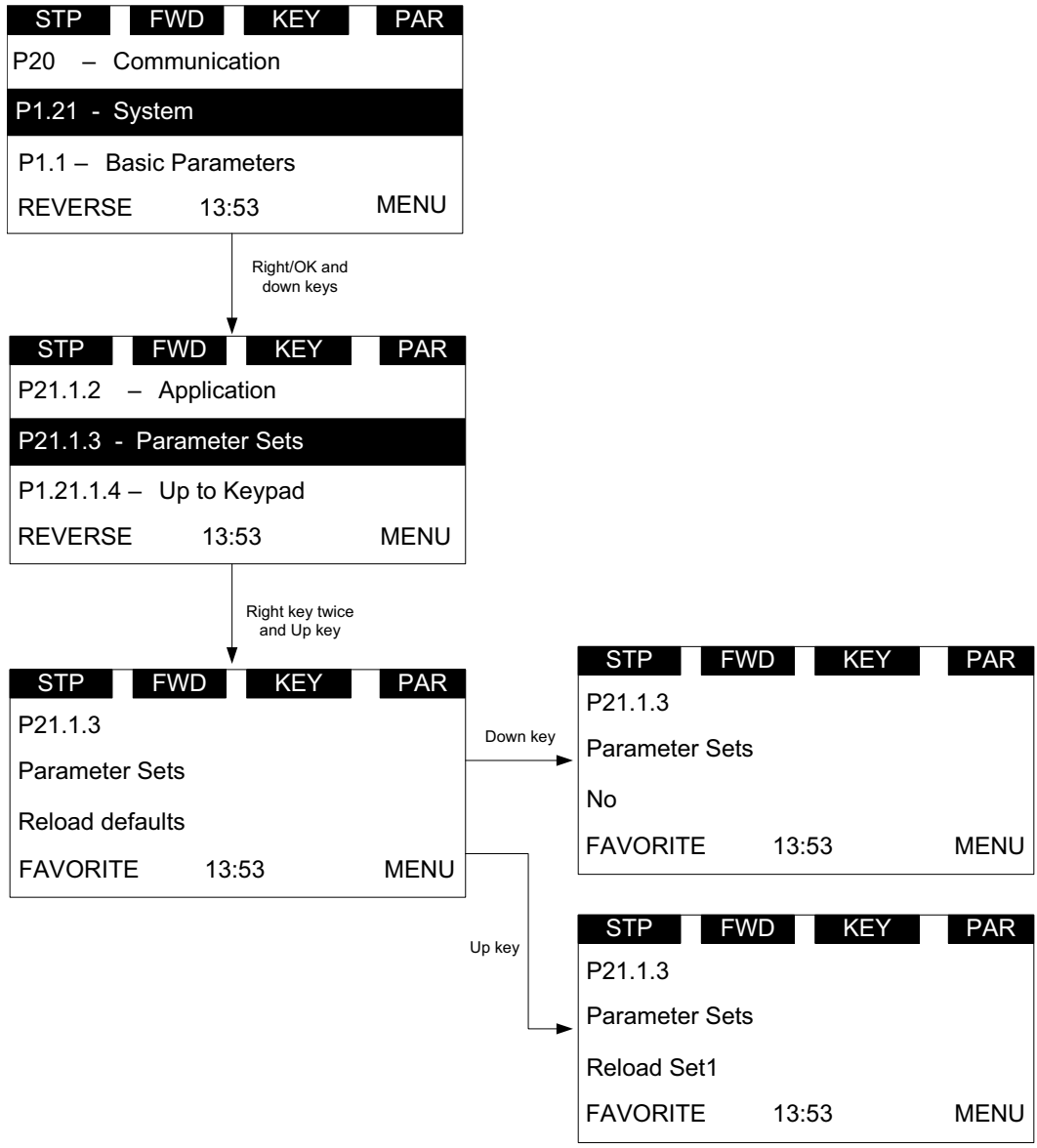
There are several special pages:

1. P21.1.3 Parameter Sets. See **Figure 21**.

User shall be able to load or store parameters. The options are as follows: Reload Defaults, Reload Set 1, Reload Set 2, Store Set 1, Store Set 2, Reset, Reload Defaults VM. The special points are:

- During this operation, “waiting...” shall flash, which means it is in process.
- When it is finished, “OK” shall be shown.
- Drive shall restart after default parameters are loaded.
- “Reload Defaults VM” is for the sales stand. Do not use on a fully functioning drive.

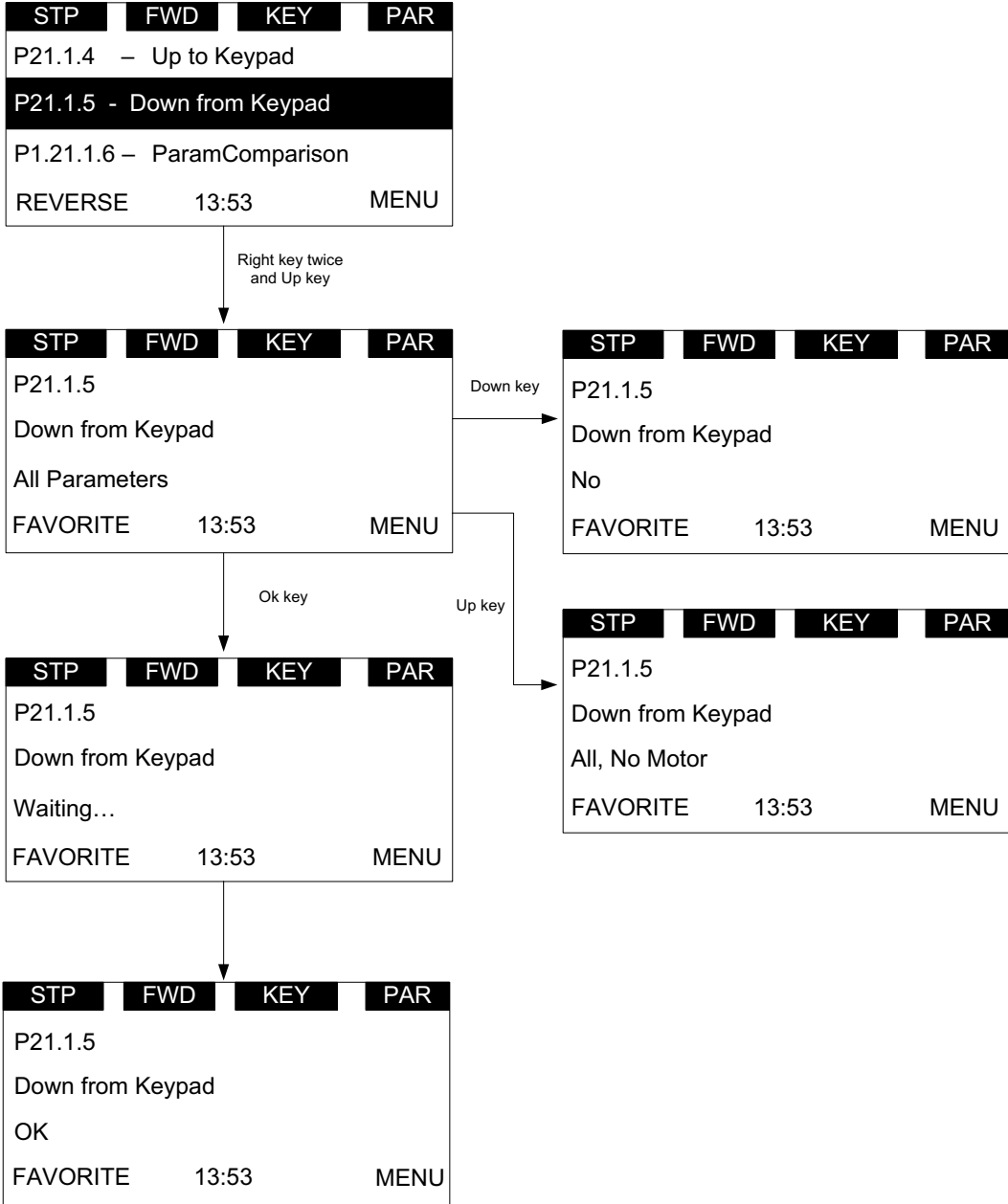
Figure 21. Parameter sets.



- 2. P21.1.4 Up to keypad and P21.1.5 Down from keypad  
 During this operation, "waiting..." shall flash, which means it is in process. When it is finished, "OK" shall be shown.

This stores the parameters to keypad for transferring. Down from keypad is to download parameters from keypad to the drive. Up to keypad takes the parameters from the drive and loads them to the keypad.

Figure 22. Down from keypad.



## Chapter 3—Menu overview

### 3. P21.1.6 Parameters Comparison

After the operation, the number of different parameter will be shown. Then press the right key; the first different parameter shall be shown.

The parameter name shall be shown in the second line, and the value which is from keypad/default/set1/set2 shall be shown in the third line, the current value shall be shown in the fourth line.

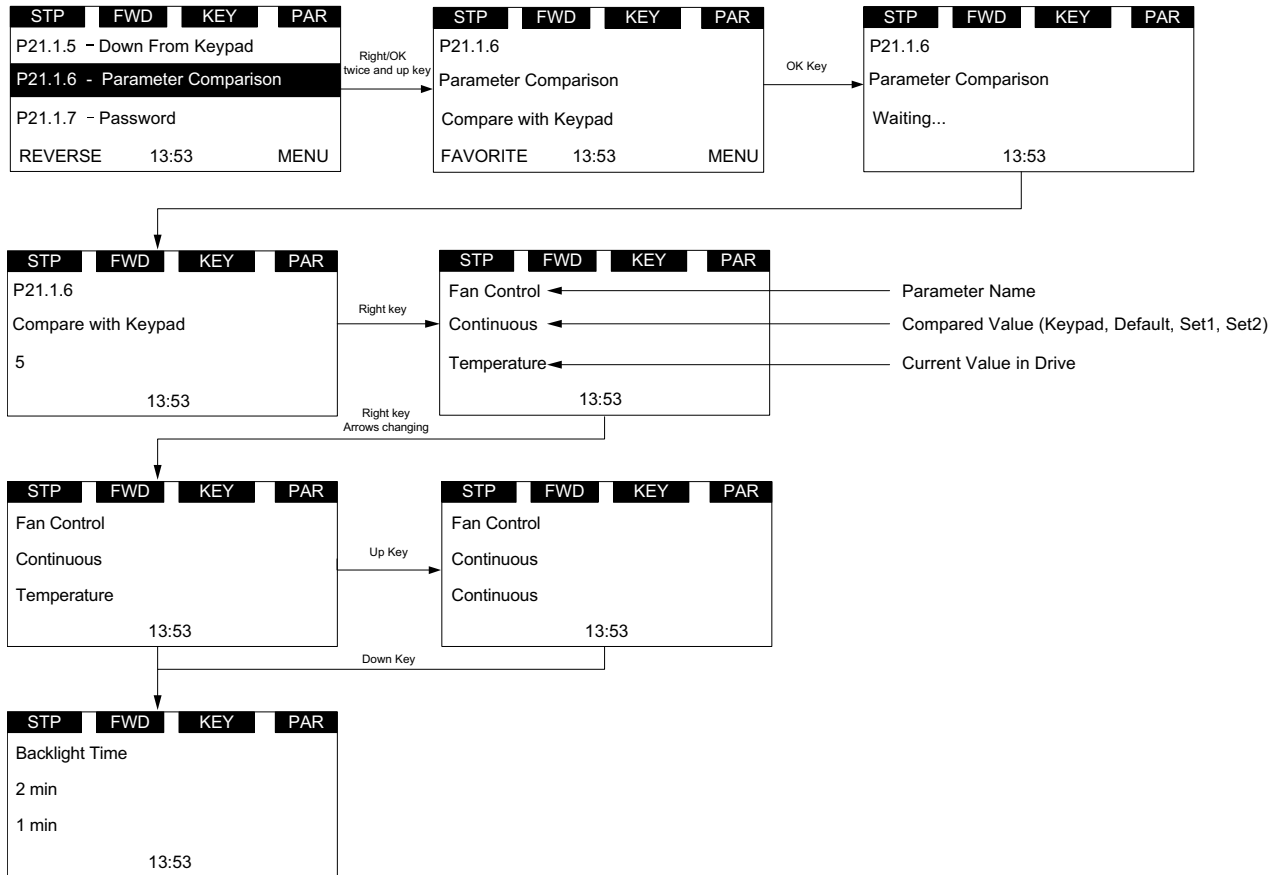
If the user wants to modify the current value, the user shall be able to enter the edit mode by right key.

The user shall be able to browse all the different parameters by up/down key.

During this operation, "waiting..." shall flash, which means it is in process.

When it is finished, "OK" shall be shown. See **Figure 23**.

**Figure 23. Parameters comparison.**



4. P21.1.7 Password

Password protects the parameters' security. Zero means not used, otherwise in use. If password is in use, user can still see the values of parameters, but needs to enter the password before editing. The user must enter current password before changing the password.

0000 shall mean that the password is not used, the password is 0000 by default.

The password range shall be 0001–9999, the setting of password and checking of password are as Figure 24.

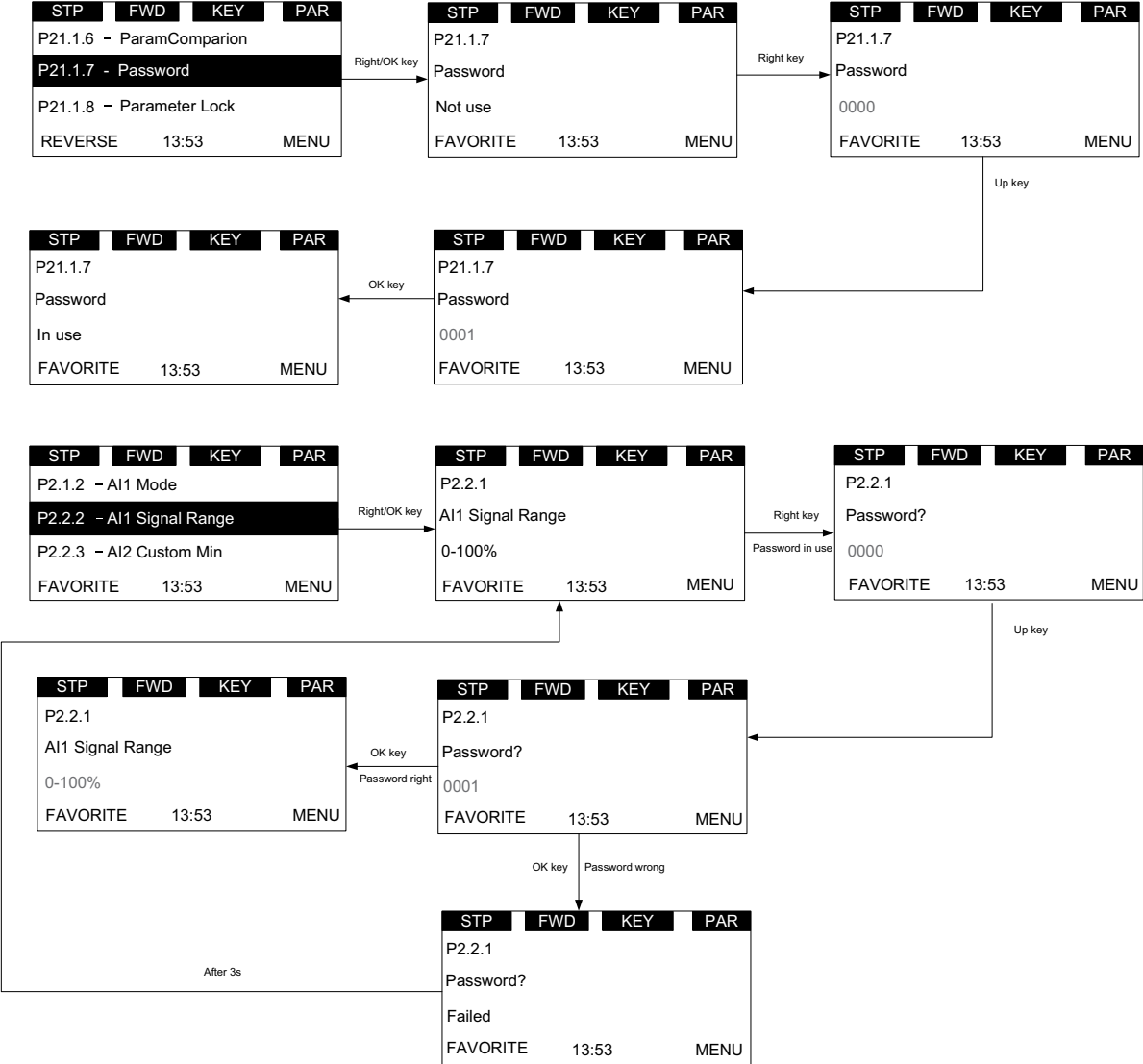
Enter the password setting page. If the password is 0000, then the “Not use” shall be shown. If the password is not 0000, then the “in use” shall be shown.

If the password is in use, and user inputs the wrong password, then the “failed” shall be shown.

After “failed” is shown 3 seconds, the page shall return to the parameter read page.

If the password is in use, and user inputs the right password, then the value shall flash, which indicates that it can be edited.

Figure 24. Password.



## Chapter 3—Menu overview

### Value edit

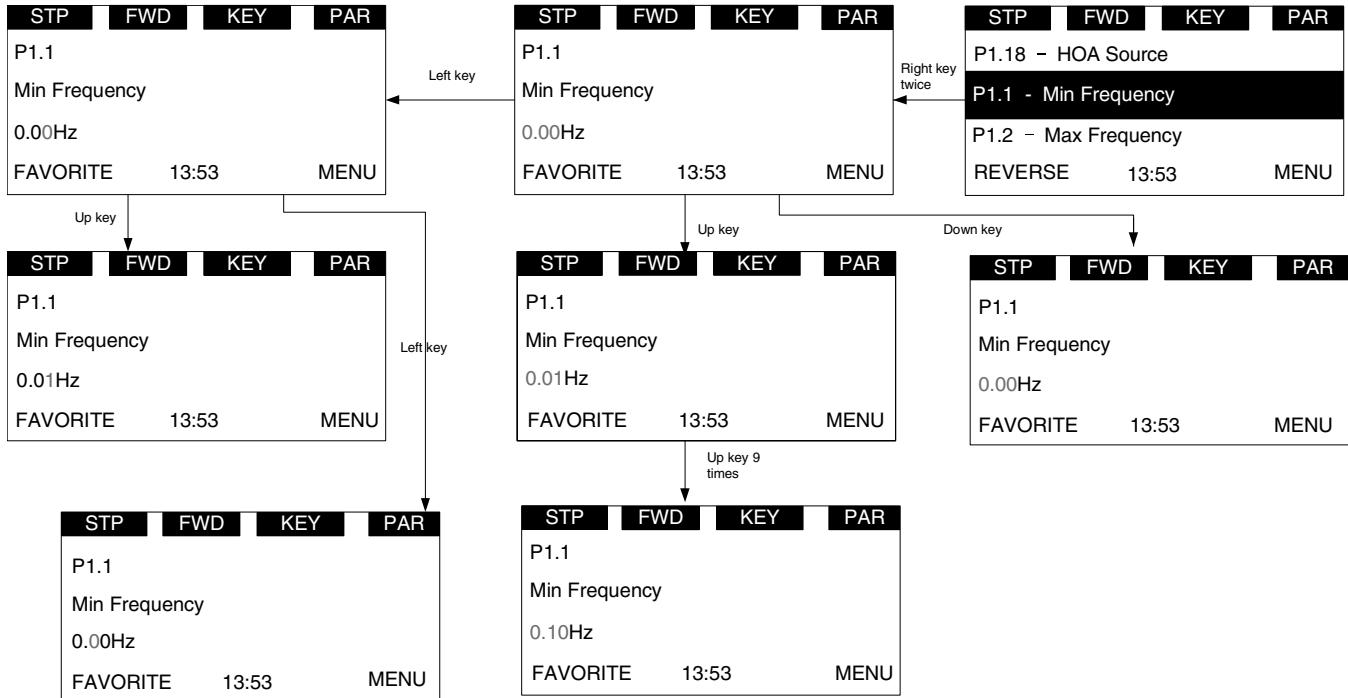
This topic shows the methods to edit value, and what will happen to edit value when password is in use and parameter lock is enabled.

We have three methods to edit value: edit by key press-hold, edit bit by bit, or edit click by click.

For details, please see **Figure 25**. For the editable parameter, press “Right” key once to enter the read mode (just read the value of this parameter), press “Right” key again to enter the edit mode (user can modify the value of this parameter), press “Right” key again to enter the bit-by-bit edit mode.

User shall use Left/Right key to change the current editable bit. When editing one number, it increases/decreases circularly, for example, pressing Up key can change to 9 from 0.

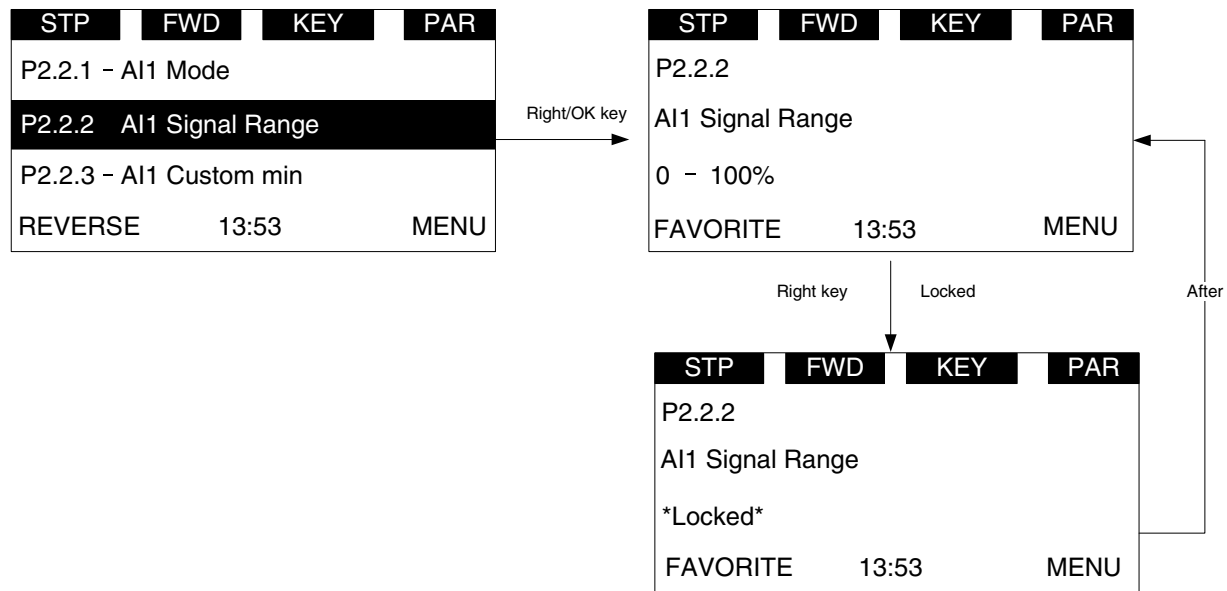
**Figure 25. Edit parameter value.**





1. If password is in use, password shall be needed to check before edit parameter value.
2. If no action in 1 min., the password shall need to be checked again.
3. If Parameter locked is enabled, \*Locked\* shall be shown if user tries to edit the parameter.

**Figure 26. Parameter locked.**



## T—favorite

Favorites collect the user's favorite parameters. The user can add one parameter into favorite list by "FAVORITE" soft key, and can delete it from favorite list by "DELETE" soft key.

If a parameter has not been added into the favorite list, the soft keys "FAVORITE" will be shown in parameter page (see **Figure 11** on **Page 14**). If it has been added into the favorite list, the soft key "FAVORITE" will not be shown.

If a parameter has been added to the favorite list, it shall appear in the favorite menu. Then when you enter into the favorite menu, the soft keys "DELETE" will be shown. This allows you to remove the selected parameter from favorite list (see **Figure 12** on **Page 14**).

After one parameter is removed from favorite list, the next parameter in the favorite list will be selected by default.

### **Chapter 4—Startup**

#### **Startup wizard page**

The Startup Wizard is a sub-menu of main menu. Once the user enters into this menu, the Startup Wizard will begin.

In the Startup Wizard, you will be prompted for essential information needed by the drive so that it can start controlling your motor. During this process, you can also select the application that best suits your needs.

If the user changes the Application, the drive and keypad will reset.

### Startup wizard

In the *Startup Wizard*, you will be prompted for essential information needed by the drive so that it can start controlling your process. In the Wizard, you will need the following keypad buttons:



Up/Down buttons.



Use these to change value.



OK button.

Confirm selection with this button, and enter into next question.



Back/Reset button.

If this button was pressed at the first question, the Startup Wizard will be cancelled.

If this button is pressed in any step on the Startup Wizard, the Startup Wizard will be cancelled.

Once you have connected power to your Eaton PowerXL frequency converter, and the Startup Wizard is enabled, follow these instructions to easily set up your drive.

**Table 16. Startup wizard instructions.**

Item	Description	
1	Startup Wizard	Press OK?
2	Application	0 = Standard 1 = Multi-Pump 2 = Multi-PID 3 = Multi-Purpose
3	Language	0 = English 1 = 中文 2 = Deutsch
4	Real Time Clock	yy.mm.dd hh:mm:ss
5	Daylight Saving	0 = Off 1 = EU 2 = US
6	Min Frequency	Min: 0.00Hz Max: Max Frequency
7	Max Frequency	Min: Min Frequency Max: 400.00Hz
8	Motor Nom Current	Min: DriveNomCurrCT*1/10 Max: DriveNomCurrCT*2
9	Current Limit	Min: Ih*1/10 Max: Ih*2
10	Motor Nom Speed	Min: 300 Max: 20000

**Table 16. Startup wizard instructions, continued.**

Item	Description	
11	Motor PF	Min: 0.30 Max: 1.0
12	Motor Nom Volt	Min: 180 V Max: 690 V
13	Motor Nom Freq	Min: 30.00 Hz Max: 400.00 Hz
14	Accel Time 1	Min: 0.1 s Max: 3000.0 s
15	Decel Time 1	Min: 0.1 s Max: 3000.0 s
16	Local Control Place	0 = Keypad 1 = I/O terminal Start 1 2 = I/O Terminal Start 2 3 = Fieldbus
17	Local Reference	0 = AI1 1 = AI2 2 = Slot A: AI1 3 = Slot B: AI1 4 = AI1 Joystick 5 = AI2 Joystick 6 = Keypad 7 = Fieldbus Ref 8 = Motor Pot 9 = Max Frequency 10 = AI1 + AI2 11 = AI1 - AI2 12 = AI2 - AI1 13 = AI1 * AI2 14 = AI1 or AI2 15 = MIN(AI1,AI2) 16 = MAX(AI1,AI2) 17 = PID1 Control Output 18 = PID2 Control Output
18	Remote 1 Control Place	0 = Keypad 1 = I/O terminal Start 1 2 = I/O Terminal Start 2 3 = Fieldbus
19	Remote 1 Reference	0 = AI1 1 = AI2 2 = Slot A: AI1 3 = Slot B: AI1 4 = AI1 Joystick 5 = AI2 Joystick 6 = Keypad 7 = Fieldbus Ref 8 = Motor Pot 9 = Max Frequency 10 = AI1 + AI2 11 = AI1 - AI2 12 = AI2 - AI1 13 = AI1 * AI2 14 = AI1 or AI2 15 = MIN(AI1,AI2) 16 = MAX(AI1,AI2) 17 = PID1 Control Output 18 = PID2 Control Output

Now the Startup Wizard is done. It will not show again at the next power up. If you want to reset it, please select it from the main menu ("Startup Wizard").

## Application macro Mini-Wizard

### Multi-pump and fan control Mini-Wizard

**Table 17. Multi-pump and fan control.**

Item	Description	
20	PID 1 Process Unit	Select Units
21	PID1 Process Unit Min	Min: -99999.99 Max: PID1 Process Unit Max
22	PID1 Process Unit Max	Min: Process Unit Min Max: 99999.99
23	PID 1 Set Point 1 Source	Select Function
24	PID 1 Keypad Set Point 1	Min: PID 1 Process Unit Min Max: PID 1 Process Unit Max
25	PID 1 Feedback 1 Source	Select Input
26	PID 1 Feedback 1 Min	Min: -200% Max: 200%
27	PID 1 Feedback 1 Max	Min: -200% Max: 200%
28	Number of Pumps	Min: 1 Max: 5
29	PID Bandwidth	Min: 0% Max: 100%
30	Add/Remove Delay	Min: 0 s Max: 3600 s
31	Interlock Enable	0 = Disabled 1 = Enabled

## PID Mini-Wizard

The PID Mini-Wizard is activated in the Quick Setup menu. This Wizard assumes that you are going to use the PID controller in the “one feedback/one setpoint” mode. The control place will be I/O A and the default process unit “%”. The PID Mini-Wizard asks for the following values to be set:

**Table 18. PID Mini-Wizard values.**

Item	Description	
20	PID 1 Process Unit	Select Units
21	PID1 Process Unit Min	Min: -99999.99 Max: PID1 Process Unit Max
22	PID1 Process Unit Max	Min: PID1 Process Unit Min Max: 99999.99
23	PID 1 Set Point 1 Source	Select Function
24	PID 1 Keypad Set Point 1	Min: PID 1 Process Unit Min Max: PID 1 Process Unit Max
25	PID 1 Feedback 1 Source	Select Input
26	PID 1 Feedback 1 Min	Min: -200% Max: 200%
27	PID 1 Feedback 1 Max	Min: -200% Max: 200%

## Chapter 5—Standard application

### Introduction

The Standard Application is typically used in basic motor control scenarios where multiple pump control, PID loops, or advanced control loops are not required. It provides the ability for the user to define its local and remote control and reference signals. In addition, there is the ability to scale the analog input and output signals to be read based off the desired motor response. There are also 8 digital inputs, 3 relay outputs, and 1 digital output that can be programmed to allow for control schemes that require the drive to have certain functions. It provides full customization on the motor control sequence with the ability to be in frequency or speed control mode, and tuning of the V/Hz curve can be selected. Drive/motor protections can be customized to defined actions for added user control. Below is a list of other features that are available in the Standard Application.

Standard Application includes functions:

- Selectable digital input function
- Selectable digital output function
- Reference filter, scaling, inversion, offset, and range
- Output signal filter, scaling, inversion, offset, and range
- Selectable analog output function
- Programmable start/stop and reverse signal logic
- Two independent sets of acceleration/deceleration ramps
- S curves
- Skip frequency
- Start source (local/remote control function)
- Reference source
- Flying start
- Jog
- Volts per Hertz control
- Real time clock function—RTC time display
- Drive temperature limit supervision
- Output frequency 1 limit supervision
- Output frequency 2 limit supervision
- Torque limit supervision
- Reference frequency limit supervision
- Power limit supervision
- Analog input limit supervision
- Auto restart
- Power loss ride through
- Trend buffer
- Programmable switching frequency
- Multi-preset speeds
- Emergency stop
- Line start lockout
- Fan control
- DC brake
- Flux brake
- Dynamic brake
- Motor current limit supervision

### I/O controls

- “Terminal to Function” (TTF) programming

The design behind the programming of the digital inputs in the DG1 drive is to use “Terminal to Function” programming, which is composed of multiple functions that get assigned a digital input to that function. The parameters in the drive are set up with specific functions and by defining the digital input and slot in some cases, depending on which options are available. For use of the drives control board inputs, they will be referred to as DigIN:1 through DigIN:8. When additional option cards are used, they will be defined as DigIN:X:IOY:Z. The X indicates the slot that the card is being installed in, which will be either A or B. The IOY determines the type of card it is, which would be IO1 or IO5. The Z indicates which input is being used on that available option card.

- “Function to Terminal” (FTT) programming

The design behind the programming of the relay outputs and digital output in the DG1 drive is to use “Function to Terminal” programming. It is composed of a terminal, be it a relay output or a digital output, that is assigned a parameter. Within that parameter, it has different functions that can be set.

## Chapter 5—Standard application

The parameters of the Standard Application are explained on **Page 35** of this manual, "Description of Parameters". The explanations are arranged according to the parameter number.

For the DI function, we use terminal programming method to function (TTF), where there is a fixed input that gets programmed to a list of functions. This allows for multiple inputs to be used for different functions. Connecting a certain input with a certain parameter function is done by give a parameter an appropriate value. The value is formed by the location of the input, either being on the standard control board or an external option board and the slot it is located in.

### Force open/force close selection

The Force Open selection would make the selected function always off. Essentially this is a virtual switch that is always open.

The Force Close selection would make the selected function always on. Essentially this is a virtual switch that is always closed.

These options are assigned to a function if we want to force a state without using a hardware input.

#### Example:

If we set Run Enable to Force Closed, the drive is always enabled. If we set the same function to Force Open, the drive would never be Enabled. If a digital input is to be used to activate this Run Enable, the function should be assigned to a hardware input (see below for DIGIN Selections).

### DIGIN selection

This allows assignment of a hardware digital input to a function, this is set in a format of DigIN:X where X is one of the 8 digital inputs on the main control board.

#### Example:

If we set Run Enable to DigIN:6, the drive will be enabled when digital input 6 (Terminal 8) is closed, and would not be enabled when digital input 6 (Terminal 8) is open.

### Option board DIGIN selection

This allows assignment of a hardware digital input on an option card to a function, this is set in a format of DigIN:Y:IO1:X where Y is the slot the option card is inserted on the Main control board and X is the Input on the Board and IO1 is the type of option board used.

#### Example:

If we set Run Enable to DigIN:A:IO5:6, the drive will be enabled when digital input 6 is closed on the IO5 option card which is inserted in Slot A, and would not be enabled when digital input 6 on the option card is open.

### Timer channel selection

A Time Channel is a virtual path to link the digital output of a timer function to a digital input function. To utilize this feature, a timer or interval would need to be assigned to a time channel 1 through 3, and the input function to be controlled would need to be assigned to the same time channel.

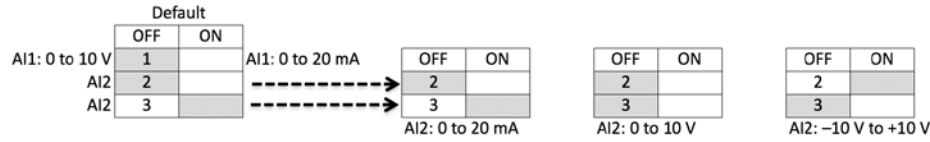
#### Example:

If we set Run Enable to DigIN:TimeChannel1, the drive will be enabled when the timer assigned to Time Channel 1 is active or High, and would not be enabled when the Time Channel is inactive or Low.

### Control I/O configuration

- Run 240 Vac and 24 Vdc control wiring in separate conduit
- Communication wire to be shielded

**Table 19. I/O connection.**



External Wiring	Pin	Signal Name	Signal	Default Setting	Description
	1	+10 V	Ref. Output Voltage	—	10 Vdc Supply Source
	2	AI1+ ①	Analog Input 1	0–10 V	Voltage Speed Reference (Programmable to 4 mA to 20 mA)
	3	AI1–	Analog Input 1 Ground	—	Analog Input 1 Common (Ground)
	4	AI2+ ①	Analog Input 2	4 mA to 20 mA	Current Speed Reference (Programmable to 0–10 V)
	5	AI2–	Analog Input 2 Ground	—	Analog Input 2 Common (Ground)
	6	GND	I/O Signal Ground	—	I/O Ground for Reference and Control
	7	DIN5	Digital Input 5	Preset Speed B0	Sets frequency output to Preset Speed 1
	8	DIN6	Digital Input 6	Preset Speed B1	Sets frequency output to Preset Speed 2
	9	DIN7	Digital Input 7	Not used (TI–)	Input forces VFD output to shut off
	10	DIN8	Digital Input 8	Force Remote (TI+)	Input takes VFD from Local to Remote
	11	CMB	DI5 to DI8 Common	Grounded	Allows source input
	12	GND	I/O Signal Ground	—	I/O Ground for Reference and Control
	13	24 V	+24 Vdc Output	—	Control voltage output (100 mA max.)
	14	DO1	Digital Output 1	Ready	Shows the drive is ready to run
	15	24 Vo	+24 Vdc Output	—	Control voltage output (100 mA max.)
	16	GND	I/O Signal Ground	—	I/O Ground for Reference and Control
	17	AO1+	Analog Output 1	Output Frequency	Shows Output frequency to motor 0–60 Hz (4 mA to 20 mA)
	18	AO2+	Analog Output 2	Motor Current	Shows Motor current of motor 0–FLA (4 mA to 20 mA)
	19	24 Vi	+24 Vdc Input	—	External control voltage input
	20	DIN1	Digital Input 1	Run Forward	Input starts drive in forward direction (start enable)
	21	DIN2	Digital Input 2	Run Reverse	Input starts drive in reverse direction (start enable)
	22	DIN3	Digital Input 3	External Fault	Input causes drive to fault
	23	DIN4	Digital Input 4	Fault Reset	Input resets active faults
	24	CMA	DI1 to DI4 Common	Grounded	Allows source input
	25	A/+	RS-485 Signal A	—	Fieldbus Communication (Modbus, BACnet)
	26	B/-	RS-485 Signal B	—	Fieldbus Communication (Modbus, BACnet)
	27	R3NO	Relay 3 Normally Open	At Speed	Relay output 3 shows VFD is at Ref. Frequency
	28	R1NC	Relay 1 Normally Closed	Run	Relay output 1 shows VFD is in a run state
	29	R1CM	Relay 1 Common	—	—
	30	R1NO	Relay 1 Normally Open	—	—
	31	R3CM	Relay 3 Common	At Speed	Relay output 3 shows VFD is at Ref. Frequency
	32	R2NC	Relay 2 Normally Closed	Fault	Relay output 2 shows VFD is in a fault state
	33	R2CM	Relay 2 Common	—	—
	34	R2NO	Relay 2 Normally Open	—	—

**Notes:** The above wiring demonstrates a SINK configuration. It is important that CMA and CMB are wired to ground (as shown by dashed line). If a SOURCE configuration is desired, wire 24 V to CMA and CMB and close the inputs to ground. When using the +10 V for AI1, it is important to wire AI1— to ground (as shown by dashed line). If using +10 V for AI1 or AI2, terminals 3, 5, and 6 need to be jumpered together.  
 ① AI1+ and AI2+ support 10K potentiometer.

**Table 20. Drive communication ports.**

<b>Port</b>	<b>Communication</b>
<b>RJ45 Keypad Port</b>	
Upload/Download Parameters	USB to RJ45
Remote Mount Keypad	Ethernet
Upgrade Drive Firmware	USB to RJ45
<b>RJ45 Ethernet Port</b>	
Upload/Download Parameters	Ethernet
Ethernet IP Communications	Ethernet
Modbus TCP Communications	Ethernet
<b>RS-485 Serial Port □</b>	
Upload/Download Parameters	Two-Wire Twisted Pair
Upgrade Drive Firmware	Two-Wire Twisted Pair
Modbus RTU Communications	Two-Wire Twisted Pair
BACnet MS/TP Communications	Two-Wire Twisted Pair

① Shielded wire recommended.



## Standard application—parameters list

On the next pages you will find the lists of parameters within the respective parameter groups. The parameter descriptions are given on **Page 194**, “Description of Parameters.” The descriptions are arranged according to the parameter number.

Column explanations:

Code = Location indication on the keypad; shows the operator the present parameter number

Parameter = Name of parameter

Min. = Minimum value of parameter

Max. = Maximum value of parameter

Unit = Unit of parameter value; given if available

Default = Value preset by factory

ID = ID number of the parameter

**Table 21. Monitor—M.**

Code	Parameter	Min.	Max.	Unit	Default	ID	Note
M1	Output Frequency			Hz		1	
M2	Freq Reference			Hz		24	
M3	Motor Speed			rpm		2	
M4	Motor Current			A		3	
M5	Motor Torque			%		4	
M6	Motor Power			%		5	
M7	Motor Voltage			V		6	
M8	DC-link Voltage			V		7	
M9	Unit Temperature			Deg. C		8	
M10	Motor Temperature			%		9	
M12	Analog Input 1			Varies		10	
M13	Analog Input 2			Varies		11	
M14	Analog Output 1			Varies		25	
M15	Analog Output 2			Varies		575	
M16	DI1, DI2, DI3					12	
M17	DI4, DI5, DI6					13	
M18	DI7, DI8					576	
M19	DO1,Virtual RO1,Virtual RO2					14	
M20	RO1, RO2, RO3					557	
M41	PT100 Temperature			Deg. C	1000.0	27	
M42	Latest Fault Code					28	
M43	RTC Battery Status				0	583	0 = Not Installed 1 = Installed 2 = Change Battery 3 = OverVoltage
M44	Instant Motor Power			kW		1686	
M45	Energy Savings			Varies	0.000	2120	
M46	Control Board DIDO Status					2209	
M47	SlotA DIDO Status					2210	
M48	SlotB DIDO Status					2211	
M49	Application Status Word					29	
M50	Standard Status Word					2414	
M51	Output			Varies		2445	
M52	Reference			Varies		2447	

- Note:**
- ① Parameter value can only be changed after the drive has stopped.
  - ② Parameter value will be set to be default when changing macros.
  - ③ Input function is level sensed.
  - ④ Input function is edge sensed.
  - ⑤ Input function is edge sensed when using StartP/StopP start logic.

**Table 21. Monitor—M, continued.**

Code	Parameter	Min.	Max.	Unit	Default	ID	Note
M53	Total MWh Count			Mwh		601	
M54	Total Power Day Count					603	
M55	Total Power Hr Count					606	
M56	Trip MWh Count			Mwh		604	
M57	Trip Power Day Count					636	
M58	Trip Power Hr Count					637	
M59	Total Run time Count			h		2827	
M60	Numbers Of Start					2830	
M61	Trip Run Time Count			h		2829	
M62	FB Status Word					2101	
M63	FB Ctrol Word					2001	
M64	FB Speed Reference	0.00	100.00	%		2003	
M65	Multi-Monitoring				2, 1, 3, 2, 1, 3, 2, 1, 3	1753	

## Parameters

**Table 22. Basic parameters—P1.**

Code	Parameter	Min.	Max.	Unit	Default	ID	Note
P1.1	Min Frequency	0.00	See Par ID 102	Hz	0.00	101	
P1.2 ①	Max Frequency	See Par ID 101	400.00	Hz	MaxFreqMFG	102	
P1.3	Accel Time 1	0.1	3000.0	s	3.0	103	
P1.4	Decel Time 1	0.1	3000.0	s	3.0	104	
P1.5 ①	Motor Nom Current	DriveNomCurrCT*1/10	DriveNomCurrCT*2	A	DriveNomCurrCT	486	
P1.6 ①	Motor Nom Speed	300	24000	rpm	MotorNomSpeedMFG	489	
P1.7 ①	Motor PF	0.30	1.00		0.85	490	
P1.8 ①	Motor Nom Voltage	180	690	V	MotorNomVoltMFG	487	
P1.9 ①	Motor Nom Frequency	8.00	400.00	Hz	MotorNomFreqMFG	488	
P1.10	Power Up Local Remote Select				0	1685	0 = Hold Last 1 = Local Control 2 = Remote control
P1.11	Remote 1 Control Place				0	135	0 = I/O Terminal Start 1 1 = Fieldbus 2 = I/O Terminal Start 2 3 = Keypad
P1.12	Local Control Place				0	1695	0 = Keypad 1 = I/O Terminal Start 1 2 = I/O Terminal Start 2 3 = Fieldbus
P1.13	Bumpless Enable				0	2462	0 = Disabled 1 = Enabled

- Note:**
- ① Parameter value can only be changed after the drive has stopped.
  - ② Parameter value will be set to be default when changing macros.
  - ③ Input function is level sensed.
  - ④ Input function is edge sensed.
  - ⑤ Input function is edge sensed when using StartP/StopP start logic.

**Table 22. Basic parameters—P1, continued.**

Code	Parameter	Min.	Max.	Unit	Default	ID	Note
P1.14 ①②	Local Reference				6	136	0 = AI1 1 = AI2 2 = Slot A: AI1 3 = Slot B: AI1 4 = AI1 Joystick 5 = AI2 Joystick 6 = Keypad 7 = Fieldbus Ref 9 = Max Frequency 10 = AI1 + AI2 11 = AI1 - AI2 12 = AI2 - AI1 13 = AI1 * AI2 14 = AI1 or AI2 15 = MIN (AI1,AI2) 16 = MAX (AI1,AI2)
P1.15 ①②	Remote 1 Reference				0	137	See Par ID 136
P1.16 ①	Reverse Enable				1	1679	See Par ID 2462
P1.17	Run Delay Time	0	32500	s	0	2423	
P1.18 ①	HOA Source				0	2465	0 = Disabled 1 = IO Terminal 2 = Keypad
P1.19 ①	Minimum Run Time	0	32500	s	0	1813	
P1.20	Frequency Reference Upper Limit	See Par ID 101	See Par ID 102	Hz	50.00	2840	
P1.21	Frequency Reference Upper Limit Source				0	2841	0 = Not Used 1 = Freq. Ref. Upper 2 = AI1 3 = AI2

## Analog Input

**Table 23. Basic setting—P2.1.**

Code	Parameter	Min.	Max.	Unit	Default	ID	Note
P2.1.1	AI Ref Scale Min Value	0.00	See Par ID 145	Hz	0.00	144	
P2.1.2	AI Ref Scale Max Value	See Par ID 144	400.00	Hz	0.00	145	

**Table 24. AI1 settings—P2.2.**

Code	Parameter	Min.	Max.	Unit	Default	ID	Note
P2.2.1	AI1 Mode				1	222	0 = 0–20 mA 1 = 0–10 V
P2.2.2	AI1 Signal Range				0	175	0 = 0–100%/ 0–20 mA/0–10 V 1 = 20–100%/ 4–20 mA/2–10 V 2 = Customized
P2.2.3	AI1 Custom Min	0.00	See Par ID 177	%	0.00	176	
P2.2.4	AI1 Custom Max	See Par ID 176	100.00	%	100.00	177	
P2.2.5	AI1 Filter Time	0.00	10.00	s	0.10	174	
P2.2.6	AI1 Signal Invert				0	181	0 = Not Inverted 1 = Inverted
P2.2.7	AI1 Joystick Hyst	0.00	20.00	%	0.00	178	
P2.2.8	AI1 Sleep Limit	0.00	100.00	%	0.00	179	
P2.2.9	AI1 Sleep Delay	0.00	320.00	s	0.00	180	
P2.2.10	AI1 Joystick Offset	-50.00	50.00	%	0.00	133	

**Note:** ① Parameter value can only be changed after the drive has stopped.  
 ② Parameter value will be set to be default when changing macros.  
 ③ Input function is level sensed.  
 ④ Input function is edge sensed.  
 ⑤ Input function is edge sensed when using StartP/StopP start logic.

## Chapter 5—Standard application

**Table 25. AI2 settings—P2.3.**

Code	Parameter	Min.	Max.	Unit	Default	ID	Note
P2.3.1	AI2 Mode				0	223	0 = 0–20 mA 1 = 0–10 V 2 = -10 to +10 V
P2.3.2	AI2 Signal Range				1	183	0 = 0–100%/0–20mA/ 0–10 V/-10 to 10 V 1 = 20–100%/4–20 mA/ 2–10 V/-6 to 10 V 2 = Customized
P2.3.3	AI2 Custom Min	0.00	See Par ID 185	%	0.00	184	
P2.3.4	AI2 Custom Max	See Par ID 184	100.00	%	100.00	185	
P2.3.5	AI2 Filter Time	0.00	10.00	s	0.10	182	
P2.3.6	AI2 Signal Invert				0	189	See Par ID 181
P2.3.7	AI2 Joystick Hyst	0.00	20.00	%	0.00	186	
P2.3.8	AI2 Sleep Limit	0.00	100.00	%	0.00	187	
P2.3.9	AI2 Sleep Delay	0.00	320.00	s	0.00	188	
P2.3.10	AI2 Joystick Offset	-50.00	50.00	%	0.00	134	

**Table 26. Fine adjust—P2.4.**

Code	Parameter	Min.	Max.	Unit	Default	ID	Note
P2.4.1 ①	Fine Tuning Input				0	2484	0 = Not Used 1 = AI1 2 = AI2 3 = Slot A: AI1 4 = Slot B: AI1 5 = Fieldbus
P2.4.2 ①	Fine Tuning Min	0.0	100.0	%	0.0	2485	
P2.4.3 ①	Fine Tuning Max	0.0	100.0	%	0.0	2486	

**Table 27. Digital input—P3.**

Code	Parameter	Min.	Max.	Unit	Default	ID	Note
P3.1 ①	IO Terminal 1 Start Stop Logic				0	143	0 = Forward - Reverse 1 = Start - Reverse 2 = Start - Enable 3 = 3 Wire Control
P3.2 ②③	IO Terminal 1 Start Signal 1				2	190	0 = DigIN:NormallyOpen 1 = DigIN:NormallyClose 2 = DigIN: 1 3 = DigIN: 2 4 = DigIN: 3 5 = DigIN: 4 6 = DigIN: 5 7 = DigIN: 6 8 = DigIN: 7 9 = DigIN: 8 10 = DigIN: A: IO1: 1 11 = DigIN: A: IO1: 2 12 = DigIN: A: IO1: 3 13 = DigIN: A: IO5: 1 14 = DigIN: A: IO5: 2 15 = DigIN: A: IO5: 3 16 = DigIN: A: IO5: 4 17 = DigIN: A: IO5: 5 18 = DigIN: A: IO5: 6

- Note:**
- ① Parameter value can only be changed after the drive has stopped.
  - ② Parameter value will be set to be default when changing macros.
  - ③ Input function is level sensed.
  - ④ Input function is edge sensed.
  - ⑤ Input function is edge sensed when using StartP/StopP start logic.

**Table 27. Digital Input—P3, continued.**

Code	Parameter	Min.	Max.	Unit	Default	ID	Note
P3.2 ②⑤, continued	IO Terminal 1 Start Signal 1				2	190	19 = DigIN: B: IO1: 1 20 = DigIN: B: IO1: 2 21 = DigIN: B: IO1: 3 22 = DigIN: B: IO5: 1 23 = DigIN: B: IO5: 2 24 = DigIN: B: IO5: 3 25 = DigIN: B: IO5: 4 26 = DigIN: B: IO5: 5 27 = DigIN: B: IO5: 6 31 = RO1 Function 32 = RO2 Function 33 = RO3 Function 34 = Virtual RO1 Function 35 = Virtual RO2 Function
P3.3 ②⑤	IO Terminal 1 Start Signal 2				3	191	See Par ID 190
P3.4 ①	Thermistor Input Select				0	881	0 = Digital Input 1 = Thermistor Input
P3.5 ②③	Reverse				0	198	See Par ID 190
P3.6 ②③	Ext. Fault 1 NO				4	192	See Par ID 190
P3.7 ②③	Ext. Fault 1 NC				1	193	See Par ID 190
P3.8 ②④	Fault Reset				5	200	See Par ID 190
P3.9 ②③	Run Enable				1	194	See Par ID 190
P3.10 ②③	Preset Speed B0				6	205	See Par ID 190
P3.11 ②③	Preset Speed B1				7	206	See Par ID 190
P3.12 ②③	Preset Speed B2				0	207	See Par ID 190
P3.15 ②③	Accel/Decel Time Set				0	195	See Par ID 190
P3.16 ②③	Accel/Decel Prohibit				0	201	See Par ID 190
P3.17 ②④	No Access To Param				0	215	See Par ID 190
P3.21 ②③	Remote Control				9	196	See Par ID 190
P3.22 ②③	Local Control				0	197	See Par ID 190
P3.23 ②③	Remote 1/2 Select				0	209	See Par ID 190
P3.26 ②③	DC Brake Active				0	202	See Par ID 190
P3.32 ②③	Jog Enable				0	199	See Par ID 190
P3.36 ②③	AI Ref Source Select				0	208	See Par ID 190
P3.42 ②③	Ext Fault-AR				1	747	See Par ID 190
P3.45 ①	IO Terminal 2 Start Stop Logic				0	2206	See Par ID 143
P3.46 ②⑤	IO Terminal 2 Start Signal 1				2	2207	See Par ID 190
P3.47 ②⑤	IO Terminal 2 Start Signal 2				3	2208	See Par ID 190
P3.48 ②③	Ext. Fault 2 NO				0	2293	See Par ID 190
P3.49 ②③	Ext. Fault 2 NC				1	2294	See Par ID 190
P3.50 ②③	Ext. Fault 3 NO				0	2295	See Par ID 190
P3.51 ②③	Ext. Fault 3 NC				1	2296	See Par ID 190

**Note:** ① Parameter value can only be changed after the drive has stopped.  
 ② Parameter value will be set to be default when changing macros.  
 ③ Input function is level sensed.  
 ④ Input function is edge sensed.  
 ⑤ Input function is edge sensed when using StartP/StopP start logic.

**Table 27. Digital Input—P3, continued.**

Code	Parameter	Min.	Max.	Unit	Default	ID	Note
P3.52	Ext. Fault 1 Text				0	2297	0 = External Fault 1 = Vibration Cut out 2 = High Motor temp 3 = Low Pressure 4 = High Pressure 5 = Low Water 6 = Damper Interlock 7 = Run Enable 8 = Freeze Stat Trip 9 = Smoke Detect 10 = Seal Leakage 11 = Rod Breakage 12 = Torque Limit
P3.53	Ext. Fault 2 Text				1	2298	See Par ID 2297
P3.54	Ext. Fault 3 Text				2	2299	See Par ID 2297
P3.55 ②④	Parameter Set1/2 Sel				0	2312	See Par ID 190
P3.57 ②③	HOA On/Off				1	2395	See Par ID 190
P3.59 ②③	OP Cont Interlock NO				4	2801	See Par ID 190
P3.60 ②③	OP Cont Interlock NC				1	2802	See Par ID 190
P3.61 ③	CP Interlock NC				1	2894	See Par ID 190

**Table 28. Analog output—P4.**

Code	Parameter	Min.	Max.	Unit	Default	ID	Note
P4.1	AO1 Mode				0	227	See Par ID 222
P4.2 ②	AO1 Function				1	146	0 = Not Used 1 = Output Frequency 2 = Freq Reference 3 = Motor Speed 4 = Motor Current 5 = Motor Torque (0–Nom) 6 = Motor Power 7 = Motor Voltage 8 = DC-Bus Voltage 19 = AI1 20 = AI2 21 = Output Freq (–2 ± 2N) 22 = Motor Torque (–2 ± 2N) 23 = Motor Power (–2 ± 2N) 24 = PT100 Temperature 33 = SlotA PT100 Temp Channel 1 34 = SlotA PT100 Temp Channel 2 35 = SlotA PT100 Temp Channel 3 36 = SlotB PT100 Temp Channel 1 37 = SlotB PT100 Temp Channel 2 38 = SlotB PT100 Temp Channel 3 39 = User Defined Output 40 = Motor Current (–2 ± 2N)
P4.3	AO1 Minimum				1	149	0 = 0 V/0 mA 1 = 2 V/4 mA
P4.4	AO1 Filter Time	0.00	10.00	s	1.00	147	
P4.5	AO1 Scale	10	1000	%	100	150	
P4.6	AO1 Inversion				0	148	See Par ID 181

- Note:** ① Parameter value can only be changed after the drive has stopped.  
 ② Parameter value will be set to be default when changing macros.  
 ③ Input function is level sensed.  
 ④ Input function is edge sensed.  
 ⑤ Input function is edge sensed when using StartP/StopP start logic.

**Table 28. Analog Output—P4, continued.**

Code	Parameter	Min.	Max.	Unit	Default	ID	Note
P4.7	A01 Offset	-100.00	100.00	%	0.00	173	
P4.8	A02 Mode				0	228	See Par ID 222
P4.9 ②	A02 Function				4	229	See Par ID 146
P4.10	A02 Minimum				1	232	See Par ID 149
P4.11	A02 Filter Time	0.00	10.00	s	1.00	230	
P4.12	A02 Scale	10	1000	%	100	233	
P4.13	A02 Inversion				0	231	See Par ID 181
P4.14	A02 Offset	-100.00	100.00	%	0.00	234	

**Table 29. Digital output—P5.**

Code	Parameter	Min.	Max.	Unit	Default	ID	Note
P5.1 ②	DO1 Function				1	151	0 = Not Used 1 = Ready 2 = Run 3 = Fault 4 = Fault Invert 5 = Warning 6 = Reversed 7 = At Speed 8 = Zero Frequency 9 = Freq Limit 1 Superv 10 = Freq Limit 2 Superv 13 = OverHeat Fault 14 = OverCurrent Regular 15 = OverVoltage Regular 16 = UnderVoltage Regular 17 = 4 mA Ref Fault/ Warning 20 = Torq Limit Superv 21 = Ref Limit Superv 22 = Control from I/O 23 = Un-Requested Rotation Direction 24 = Thermistor Fault Output 27 = Ext Fault/Warning 28 = Remote Control 29 = Jog Speed Select 30 = Motor Therm Protection 31 = FB Digital Input 1 32 = FB Digital Input 2 33 = FB Digital Input 3 34 = FB Digital Input 4 39 = In E-Stop 40 = Power Limit Superv 41 = Temp Limit Superv 42 = Analog Input Superv 51 = Motor Current 1 Supv 52 = Motor Current 2 Supv 53 = Second AI Limit Supv 54 = DC Charge Switch Close 55 = Preheat Active 56 = Cold Weather Active 58 = 2th Stage Ramp Frequency Active 59 = STO Fault Output 60 = Run Bypass/Drive 63 = Auto Local On COM Fault 64 = FieldBus RTU Fault

- Note:** ① Parameter value can only be changed after the drive has stopped.  
 ② Parameter value will be set to be default when changing macros.  
 ③ Input function is level sensed.  
 ④ Input function is edge sensed.  
 ⑤ Input function is edge sensed when using StartP/StopP start logic.

## Chapter 5—Standard application

**Table 29. Digital Output—P5, continued.**

Code	Parameter	Min.	Max.	Unit	Default	ID	Note
P5.1 ②, continued	D01 Function				1	151	65 = FieldBus TCP Fault 66 = FieldBus MSTP Fault 67 = FieldBus EIP Fault 68 = FieldBus SlotA Fault 69 = FieldBus SlotB Fault 70 = FieldBus SWD Fault 78 = CP Interlock Fault
P5.2 ②	RO1 Function				2	152	See Par ID 151
P5.3 ②	RO2 Function				3	153	See Par ID 151
P5.4 ②	RO3 Function				7	538	See Par ID 151
P5.5 ②	Virtual RO1 Function				0	2463	See Par ID 151
P5.6 ②	Virtual RO2 Function				0	2464	See Par ID 151
P5.7 ②	Freq Limit 1 Supv				0	154	0 = No Limit 1 = Low Limit Superv 2 = High Limit Superv
P5.8	Freq Limit 1 Supv Val	0.00	See Par ID 102	Hz	0.00	155	
P5.9 ②	Freq Limit 2 Supv				0	157	0 = No Limit 1 = Low Limit Superv 2 = High Limit Superv
P5.10	Freq Limit 2 Supv Val	0.00	See Par ID 102	Hz	0.00	158	
P5.11 ②	Torque Limit Supv				0	159	0 = No Limit 1 = Low Limit Superv 2 = High Limit Superv
P5.12 ②	Torque Limit Supv Val	-1000.0	1000.0	%	100.0	160	
P5.13	Ref Limit Supv				0	161	0 = No Limit 1 = Low Limit Superv 2 = High Limit Superv
P5.14	Ref Limit Supv Val	0.00	See Par ID 102	Hz	0.00	162	
P5.17	Temp Limit Supv				0	165	See Par ID 161
P5.18	Temp Limit Supv Val	-10.0	75.0	Deg. C	40.0	166	
P5.19	Power Limit Supv				0	167	See Par ID 161
P5.20	Power Limit Supv Val	-200.0	200.0	%	0.0	168	
P5.21	AI Supv Select				0	170	0 = AI1 1 = AI2
P5.22	AI Limit Supv				0	171	See Par ID 161
P5.23	AI Limit Supv Val	0.00	100.00	%	0.00	172	
P5.32	RO1 On Delay	0.0	320.0	s	0.0	2112	
P5.33	RO1 Off Delay	0.0	320.0	s	0.0	2113	
P5.34	RO2 On Delay	0.0	320.0	s	0.0	2114	
P5.35	RO2 Off Delay	0.0	320.0	s	0.0	2115	
P5.36	RO3 On Delay	0.0	320.0	s	0.0	2116	
P5.37	RO3 Off Delay	0.0	320.0	s	0.0	2117	
P5.38	RO3 Reverse				0	2118	0 = No 1 = Yes
P5.39 ②	Motor Current 1 Supv				0	2189	See Par ID 159
P5.40	Motor Current 1 Supv Value	0.0	DriveNomCurrCT*2	A	DriveNomCurrCT	2190	
P5.41 ②	Motor Current 2 Supv				0	2191	See Par ID 159
P5.42	Motor Current 2 Supv Value	0.0	DriveNomCurrCT*2	A	DriveNomCurrCT	2192	
P5.43	Second AI Supv Select				0	2193	See Par ID 170
P5.44	Second AI Limit Supv				0	2194	See Par ID 161
P5.45	Second AI Limit Supv Val	0.00	100.00	%	0.00	2195	

- Note:**
- ① Parameter value can only be changed after the drive has stopped.
  - ② Parameter value will be set to be default when changing macros.
  - ③ Input function is level sensed.
  - ④ Input function is edge sensed.
  - ⑤ Input function is edge sensed when using StartP/StopP start logic.



**Table 29. Digital Output—P5, continued.**

Code	Parameter	Min.	Max.	Unit	Default	ID	Note
P5.46	Motor Current 1 Supv Hyst	0.1	1.0	A	0.1	2196	
P5.47	Motor Current 2 Supv Hyst	0.1	1.0	A	0.1	2197	
P5.48	AI Supv Hyst	1.00	10.00	%	1.00	2198	
P5.49	Second AI Supv Hyst	1.00	10.00	%	1.00	2199	
P5.50	Freq Limit 1 Supv Hyst	0.10	1.00	Hz	0.10	2200	
P5.51	Freq Limit 2 Supv Hyst	0.10	1.00	Hz	0.10	2201	
P5.52	Torque Limit Supv Hyst	1.0	5.0	%	1.0	2202	
P5.53	Ref Limit Supv Hyst	0.10	1.00	Hz	0.10	2203	
P5.54	Temp Limit Supv Hyst	1.0	10.0	Deg. C	1.0	2204	
P5.55	Power Limit Supv Hyst	0.1	10.0	%	0.1	2205	
P5.56	Virtual R01 On Delay	0.0	320.0	s	0.0	2848	
P5.57	Virtual R01 Off Delay	0.0	320.0	s	0.0	2849	
P5.58	Virtual R02 On Delay	0.0	320.0	s	0.0	2850	
P5.59	Virtual R02 Off Delay	0.0	320.0	s	0.0	2851	

**Table 30. Drive control—P7.**

Code	Parameter	Min.	Max.	Unit	Default	ID	Note
P7.1	Remote 2 Control Place				1	138	See Par ID 135
P7.2 ①②	Remote 2 Reference				7	139	See Par ID 136
P7.3	Keypad Reference	See Par ID 101	See Par ID 102	Hz	0.00	141	
P7.4	Keypad Direction				0	116	0 = Forward 1 = Reverse
P7.5	Keypad Stop				1	114	0 = Enabled-Keypad Operation 1 = Always Enabled
P7.6	Jog Reference	0.00	See Par ID 102	Hz	5.00	117	
P7.9	Start Mode				0	252	0 = Ramp 1 = Flying Start From Stop Frequency 2 = Flying Start From Max Frequency
P7.10	Stop Mode				1	253	0 = Coasting 1 = Ramp
P7.11	Ramp 1 Shape	0.0	10.0	s	0.0	247	
P7.12	Ramp 2 Shape	0.0	10.0	s	0.0	248	
P7.13	Accel Time 2	0.1	3000.0	s	10.0	249	
P7.14	Decel Time 2	0.1	3000.0	s	10.0	250	
P7.15	Skip F1 Low Limit	0.00	See Par ID 257	Hz	0.00	256	
P7.16	Skip F1 High Limit	See Par ID 256	400.00	Hz	0.00	257	
P7.17	Skip F2 Low Limit	0.00	See Par ID 259	Hz	0.00	258	
P7.18	Skip F2 High Limit	See Par ID 258	400.00	Hz	0.00	259	
P7.19	Skip F3 Low Limit	0.00	See Par ID 261	Hz	0.00	260	
P7.20	Skip F3 High Limit	See Par ID 260	400.00	Hz	0.00	261	
P7.21	Skip Range Ramp Factor	0.1	10.0		1.0	264	
P7.22	Power Loss Function				0	267	0 = Disabled 1 = Decel Mode 2 = Coast Mode
P7.23	Power Loss Time	0.3	5.0	s	2.0	268	

**Note:** ① Parameter value can only be changed after the drive has stopped.  
 ② Parameter value will be set to be default when changing macros.  
 ③ Input function is level sensed.  
 ④ Input function is edge sensed.  
 ⑤ Input function is edge sensed when using StartP/StopP start logic.

**Table 30. Drive Control—P7, continued.**

Code	Parameter	Min.	Max.	Unit	Default	ID	Note
P7.24	Currency				0	2122	0 = \$ 1 = £ 2 = € 3 = ¥ 4 = Rs 5 = R\$ 6 = Fr 7 = kr
P7.25	Energy Cost			Varies	0.00	2123	
P7.26	Data Type				0	2124	0 = Cumulative 1 = Daily Avg 2 = Weekly Avg 3 = Monthly Avg 4 = Yearly Avg
P7.27	Energy Savings Reset					2125	0 = Not Reset 1 = Reset
P7.28 ①	2nd Stage Ramp Frequency	See Par ID 101	See Par ID 102	Hz	30.00	2444	
P7.29	Change PhaseSequence Motor				0	2515	0 = Change Disable 1 = Change Enable
P7.30	Run Remove Stop Mode				0	2667	See Par ID 253

**Table 31. Motor control—P8.**

Code	Parameter	Min.	Max.	Unit	Default	ID	Note
P8.1 ①②	Motor Control Mode				0	287	0 = Freq Control 1 = Speed Control
P8.2 ③	Current Limit	DriveNomCurrCT*1/10	DriveNomCurrCT*2	A	DriveNomCurrVT	107	
P8.3 ④	V/Hz Optimization				0	109	See Par ID 2462
P8.4 ④	V/Hz Ratio				0	108	0 = Linear 1 = Squared 2 = Programmable 3 = Linear + Flux Optimization
P8.5 ④	Field Weakening Point	8.00	400.00	Hz	FieldWeakPointMFG	289	
P8.6 ④	Voltage at FWP	10.00	200.00	%	100.00	290	
P8.7 ④	V/Hz Mid Frequency	0.00	See Par ID 289	Hz	VHzCurveMidFreqMFG	291	
P8.8 ④	V/Hz Mid Voltage	0.00	100.00	%	100.00	292	
P8.9 ④	Zero Frequency Voltage	0.00	40.00	%	0.00	293	
P8.10	Switching Frequency	MinSwitchFreq	MaxSwitchFreq	kHz	DefaultSwitchFreqCT	2522	
P8.11	Sine Filter Enable				0	1665	See Par ID 2462
P8.12 ①	OverVoltage Control				3	294	0 = Disabled 1 = REF + 8Hz 2 = Max Freq 3 = Max Freq + 8Hz
P8.14 ②	Identification				0	299	0 = No Action 1 = Identification Only Stator Resistor 2 = Identification with Run 3 = Identification No Run 4 = Identification Only Inertia
P8.17 ②	Frequency Ramp Out Filter Time Constant	0	3000	ms	0	1585	

**Note:** ① Parameter value can only be changed after the drive has stopped.  
 ② Parameter value will be set to be default when changing macros.  
 ③ Input function is level sensed.  
 ④ Input function is edge sensed.  
 ⑤ Input function is edge sensed when using StartP/StopP start logic.

**Table 31. Motor control—P8 Continued.**

Code	Parameter	Min.	Max.	Unit	Default	ID	Note
P8.50 ①	Stator Resistor	0.001	65.535	ohm	0.001	771	
P8.59	VF Stable Kd	0	3000	%	100	1656	
P8.60	VF Stable Kq	0	3000	%	100	1657	
P8.61 ①	Overmodulation Enable				0	2835	See Par ID 2462
P8.71	Slip Compensation Coefficient	0	500	%	100	1664	

**Table 32. Protections—P9.**

Code	Parameter	Min.	Max.	Unit	Default	ID	Note
P9.1 ①	4 mA Input Fault				0	306	0 = No Action 1 = Warning 2 = Warning: Previous Freq 3 = Warning: Preset Freq 4 = Fault 5 = Fault, Coast
P9.2 ②	4 mA Fault Frequency	0.00	See Par ID 102	Hz	0.00	331	
P9.3 ③	External Fault				2	307	0 = No Action 1 = Warning 2 = Fault 3 = Fault, Coast
P9.4 ④	Input Phase Fault				2	332	0 = No Action 1 = Warning 2 = Fault 3 = Fault, Coast 4 = Single Phase Power Limit
P9.5 ⑤	Uvolt Fault Response				2	330	See Par ID 307
P9.6 ⑤	Output Phase Fault				2	308	See Par ID 307
P9.7 ⑤	Ground Fault				2	309	See Par ID 307
P9.8 ⑤	Motor Thermal Protection				2	310	See Par ID 307
P9.9	Motor Thermal F0 Current	0.0	150.0	%	100.0	311	
P9.11 ①	Stall Protection				0	313	See Par ID 307
P9.12	Stall Current Limit	0.1	ActiveMotor NomCurr*2	A	ActiveMotor NomCurr*13/10	314	
P9.13	Stall Time Limit	1.0	120.0	s	15.0	315	
P9.14	Stall Frequency Limit	1.00	See Par ID 102	Hz	25.00	316	
P9.15 ①	Underload Protection				0	317	See Par ID 307
P9.16	Underload Fnom Torque	10.0	150.0	%	50.0	318	
P9.17	Underload F0 Torque	5.0	150.0	%	10.0	319	
P9.18	Underload Time Limit	2.00	600.00	s	20.00	320	
P9.19 ①	Thermistor Fault Response				2	333	See Par ID 307
P9.20	Line Start Lockout				2	750	0 = Disabled, No Change 1 = Enable, No Change 2 = Disabled, Changed 3 = Enable, Changed
P9.21 ①	Fieldbus Fault Response				2	334	0 = No Action 1 = Warning 2 = Fault 3 = Fault, Coast 4 = Warning, Coast 5 = Warning, Auto Switch To Local 6 = Warning, Auto Switch To Preset Speed 1
P9.22 ①	OPTCard Fault Response				2	335	See Par ID 307

**Note:** ① Parameter value can only be changed after the drive has stopped.  
 ② Parameter value will be set to be default when changing macros.  
 ③ Input function is level sensed.  
 ④ Input function is edge sensed.  
 ⑤ Input function is edge sensed when using StartP/StopP start logic.

**Table 32. Protections—P9, continued.**

Code	Parameter	Min.	Max.	Unit	Default	ID	Note
P9.23 ①	Unit Under Temp Prot				2	1564	See Par ID 307
P9.24	AR Wait Time	1.00	300.00	s	1.00	321	
P9.25	AR Trail Time	0.00	600.00	s	30.00	322	
P9.26	AR Start Function				0	323	0 = Flying Start From Stop Frequency 1 = Ramp 2 = Flying Start From Max Frequency
P9.27	Undervoltage Attempts	0	10		1	324	
P9.28	OverVoltage Attempts	0	10		1	325	
P9.29	OverCurrent Attempts	0	3		1	326	
P9.30	4 mA Fault Attempts	0	10		1	327	
P9.31	Motor Temp Fault Attempts	0	10		1	329	
P9.32	External Fault Attempts	0	10		1	328	
P9.33	Underload Attempts	0	10		1	336	
P9.34 ①	RTC Fault				1	955	See Par ID 307
P9.35 ①	PT100 Fault Response				2	337	See Par ID 307
P9.36 ①	Replace Battery Fault Response				1	1256	See Par ID 307
P9.37 ①	Replace Fan Fault Response				1	1257	See Par ID 307
P9.38 ①	IP Address Confliction Resp				1	1678	See Par ID 307
P9.39	Cold Weather Mode				0	2126	See Par ID 2462
P9.40	Cold Weather Volt. Level	0.0	20.0	%	2.0	2127	
P9.41	Cold Weather Time Out	0	10	min	3	2128	
P9.42	Cold Weather Password					2129	
P9.43	Under Temp Fault Override					2130	See Par ID 2118
P9.44	Ground Fault Limit	0	30	%	15	2158	
P9.45 ①	Keypad Comm Fault Response				2	2157	See Par ID 307
P9.46	Preheat Mode				0	2159	See Par ID 2462

**Note:** ① Parameter value can only be changed after the drive has stopped.  
 ② Parameter value will be set to be default when changing macros.  
 ③ Input function is level sensed.  
 ④ Input function is edge sensed.  
 ⑤ Input function is edge sensed when using StartP/StopP start logic.

**Table 32. Protections—P9, continued.**

Code	Parameter	Min.	Max.	Unit	Default	ID	Note
P9.47 ②	Preheat Control Source				31	2160	0 = DigIN:NormallyOpen 1 = DigIN:NormallyClose 2 = DigIN: 1 3 = DigIN: 2 4 = DigIN: 3 5 = DigIN: 4 6 = DigIN: 5 7 = DigIN: 6 8 = DigIN: 7 9 = DigIN: 8 10 = DigIN: A: IO1: 1 11 = DigIN: A: IO1: 2 12 = DigIN: A: IO1: 3 13 = DigIN: A: IO5: 1 14 = DigIN: A: IO5: 2 15 = DigIN: A: IO5: 3 16 = DigIN: A: IO5: 4 17 = DigIN: A: IO5: 5 18 = DigIN: A: IO5: 6 19 = DigIN: B: IO1: 1 20 = DigIN: B: IO1: 2 21 = DigIN: B: IO1: 3 22 = DigIN: B: IO5: 1 23 = DigIN: B: IO5: 2 24 = DigIN: B: IO5: 3 25 = DigIN: B: IO5: 4 26 = DigIN: B: IO5: 5 27 = DigIN: B: IO5: 6 31 = Drive Temperature 32 = SlotA PT100 Temp Channel 1 33 = SlotA PT100 Temp Channel 2 34 = SlotA PT100 Temp Channel 3 35 = SlotA Max PT100 Temp 36 = SlotB PT100 Temp Channel 1 37 = SlotB PT100 Temp Channel 2 38 = SlotB PT100 Temp Channel 3 39 = SlotB Max PT100 Temp 40 = SlotA and SlotB Max PT100 Temp
P9.48	Preheat Enter Temp	-20.0	20.0	Deg. C	10.0	2161	
P9.49	Preheat Quit Temp	-10.0	40.0	Deg. C	20.0	2162	
P9.50	Preheat Output Volt	0.0	20.0	%	2.0	2163	
P9.56	STO Fault Response				2	2427	0 = No Action 1 = Warning 2 = Fault
P9.57	Fault Reset Start				0	2483	0 = Follow Run Command 1 = Rising Edge After Fault Reset
P9.58	Warning Operation Mode				1	2657	0 = No Action 1 = Warning, No Store 2 = Warning, Store
P9.59	Fan Protection				2	2664	See Par ID 307
P9.60	Under Voltage Trip Level	DCLinkUnder VoltStopLimit	DCLinkOver VoltStopLimit	V	DCLinkUnder VoltProtectLimit	2666	
P9.61	OP Cont Interlock Attempts	0	10		1	2803	

**Note:** ① Parameter value can only be changed after the drive has stopped.  
 ② Parameter value will be set to be default when changing macros.  
 ③ Input function is level sensed.  
 ④ Input function is edge sensed.  
 ⑤ Input function is edge sensed when using StartP/StopP start logic.

**Table 32. Protections—P9, continued.**

Code	Parameter	Min.	Max.	Unit	Default	ID	Note
P9.62 ①	OP Cont Interlock Protection				2	2831	See Par ID 307
P9.63 ①	CP Interlock Run Protection				2	2895	See Par ID 307
P9.64 ①	CP Interlock Stop Protection				1	2896	0 = No Action 1 = Warning, No Store
P9.65	CP Interlock Attempts	0	10		1	2897	

**Table 33. Preset speed—P12.**

Code	Parameter	Min.	Max.	Unit	Default	ID	Note
P12.1	Preset Speed 1	0.00	See Par ID 102	Hz	5.00	105	
P12.2	Preset Speed 2	0.00	See Par ID 102	Hz	10.00	106	
P12.3	Preset Speed 3	0.00	See Par ID 102	Hz	15.00	118	
P12.4	Preset Speed 4	0.00	See Par ID 102	Hz	20.00	119	
P12.5	Preset Speed 5	0.00	See Par ID 102	Hz	25.00	120	
P12.6	Preset Speed 6	0.00	See Par ID 102	Hz	30.00	121	
P12.7	Preset Speed 7	0.00	See Par ID 102	Hz	35.00	122	

**Table 34. Brake—P14.**

Code	Parameter	Min.	Max.	Unit	Default	ID	Note
P14.1 ①	DC-Brake Current	DriveNom CurrCT*15/100	DriveNom CurrCT*15/10	A	DriveNom CurrCT*1/2	254	
P14.2 ①	Start DC-Brake Time	0.00	600.00	s	0.00	263	
P14.3 ①	Stop DC-Brake Frequency	0.10	10.00	Hz	1.50	262	
P14.4 ①	Stop DC-Brake Time	0.00	600.00	s	0.00	255	
P14.5 ①	Brake Chopper Mode				0	251	0 = Disabled 1 = B(Run) T(Rdy) 2 = External 3 = B(Rdy) T(Rdy) 4 = B(Run) T(No)
P14.6 ①	Flux Brake				0	266	0 = Off 1 = On
P14.7 ①	Flux Brake Current	ActiveMotor NomCurr*1/10	See Par ID 107	A	ActiveMotor NomCurr*1/2	265	

**Note:** ① Parameter value can only be changed after the drive has stopped.  
 ② Parameter value will be set to be default when changing macros.  
 ③ Input function is level sensed.  
 ④ Input function is edge sensed.  
 ⑤ Input function is edge sensed when using StartP/StopP start logic.

## Communication

**Table 35. FB process data input Sel—P20.1.**

Code	Parameter	Min.	Max.	Unit	Default	ID	Note
P20.1.1	FB Process Data Input 1 Sel	0	3000		2541	2533	
P20.1.2	FB Process Data Input 2 Sel	0	See Par ID 2533		2542	2534	
P20.1.3	FB Process Data Input 3 Sel	0	See Par ID 2533		2550	2535	
P20.1.4	FB Process Data Input 4 Sel	0	See Par ID 2533		0	2536	
P20.1.5	FB Process Data Input 5 Sel	0	See Par ID 2533		0	2537	
P20.1.6	FB Process Data Input 6 Sel	0	See Par ID 2533		0	2538	
P20.1.7	FB Process Data Input 7 Sel	0	See Par ID 2533		0	2539	
P20.1.8	FB Process Data Input 8 Sel	0	See Par ID 2533		0	2540	

**Table 36. FB process data output Sel—P20.2.**

Code	Parameter	Min.	Max.	Unit	Default	ID	Note
P20.2.1	FB Process Data Output 1 Sel				1	1556	
P20.2.2	FB Process Data Output 2 Sel				2	1557	
P20.2.3	FB Process Data Output 3 Sel				3	1558	
P20.2.4	FB Process Data Output 4 Sel				4	1559	
P20.2.5	FB Process Data Output 5 Sel				5	1560	
P20.2.6	FB Process Data Output 6 Sel				6	1561	
P20.2.7	FB Process Data Output 7 Sel				7	1562	
P20.2.8	FB Process Data Output 8 Sel				28	1563	
P20.2.9 ②	Standard Status Word Bit0 Function Select				1	2415	0 = Not Used 1 = Ready 2 = Run 3 = Fault 4 = Fault Invert 5 = Warning 6 = Reversed 7 = At Speed 8 = Zero Frequency 9 = Freq Limit 1 Superv 10 = Freq Limit 2 Superv 13 = OverHeat Fault 14 = OverCurrent Regular 15 = OverVoltage Regular 16 = UnderVoltage Regular 17 = 4 mA Ref Fault/Warning 20 = Torq Limit Superv 21 = Ref Limit Superv 22 = Control from I/O 23 = Un-Requested Rotation Direction

- Note:**
- ① Parameter value can only be changed after the drive has stopped.
  - ② Parameter value will be set to be default when changing macros.
  - ③ Input function is level sensed.
  - ④ Input function is edge sensed.
  - ⑤ Input function is edge sensed when using StartP/StopP start logic.

**Table 36. FB Process Data Output Sel—P20.2, continued.**

Code	Parameter	Min.	Max.	Unit	Default	ID	Note
P20.2.9 ②, continued	Standard Status Word Bit0 Function Select				1	2415	24 = Thermistor Fault Output 27 = Ext Fault/Warning 28 = Remote Control 29 = Jog Speed Select 30 = Motor Therm Protection 31 = FB Digital Input 1 32 = FB Digital Input 2 33 = FB Digital Input 3 34 = FB Digital Input 4 39 = In E-Stop 40 = Power Limit Superv 41 = Temp Limit Superv 42 = Analog Input Superv 51 = Motor Current 1 Supv 52 = Motor Current 2 Supv 53 = Second AI Limit Supv 54 = DC Charge Switch Close 55 = Preheat Active 56 = Cold Weather Active 58 = 2th Stage Ramp Frequency Active 59 = STO Fault Output 60 = Run Bypass/Drive 63 = Auto Local On COM Fault 64 = FieldBus RTU Fault 65 = FieldBus_TCP_Fault 66 = FieldBus_MSTP_Fault 67 = FieldBus_EIP_Fault 68 = FieldBus_SlotA_Fault 69 = FieldBus_SlotB_Fault 70 = FieldBus SWD Fault 78 = CP Interlock Fault
P20.2.10 ②	Standard Status Word Bit1 Function Select				2	2416	See Par ID 2415
P20.2.11 ②	Standard Status Word Bit2 Function Select				3	2417	See Par ID 2415
P20.2.12 ②	Standard Status Word Bit3 Function Select				4	2418	See Par ID 2415
P20.2.13 ②	Standard Status Word Bit4 Function Select				5	2419	See Par ID 2415
P20.2.14 ②	Standard Status Word Bit5 Function Select				6	2420	See Par ID 2415
P20.2.15 ②	Standard Status Word Bit6 Function Select				7	2421	See Par ID 2415
P20.2.16 ②	Standard Status Word Bit7 Function Select				8	2422	See Par ID 2415

- Note:**
- ① Parameter value can only be changed after the drive has stopped.
  - ② Parameter value will be set to be default when changing macros.
  - ③ Input function is level sensed.
  - ④ Input function is edge sensed.
  - ⑤ Input function is edge sensed when using StartP/StopP start logic.



## RS-485 Bus

**Table 37. Basic setting—P20.3.1.**

Code	Parameter	Min.	Max.	Unit	Default	ID	Note
P20.3.1.1 ①	RS485 Comm Set				0	586	0 = Modbus RTU 1 = BACnet MS/TP 2 = SWD

**Table 38. Modbus RTU—P20.3.2.**

Code	Parameter	Min.	Max.	Unit	Default	ID	Note
P20.3.2.1 ①	Slave Address	1	247		1	587	
P20.3.2.2 ①	Baud Rate				1	584	0 = 9600 1 = 19200 2 = 38400 3 = 57600 4 = 115200
P20.3.2.3 ①	Parity Type And Stop Bit				2	585	0 = None and 2 stop bits 1 = Odd and 1 stop bit 2 = Even and 1 stop bit 3 = None and 1 stop bit
P20.3.2.4	Modbus RTU Protocol Status					588	0 = Initial 1 = Stopped 2 = Operational 3 = Faulted
P20.3.2.5	Comm Timeout Modbus RTU	0	60000	ms	10000	593	
P20.3.2.6	Modbus RTU Fault Response				0	2516	0 = in Fieldbus Control 1 = in all Control

**Table 39. BACnet MS/TP—P20.3.3.**

Code	Parameter	Min.	Max.	Unit	Default	ID	Note
P20.3.3.1 ①	MSTP Baud Rate				2	594	0 = 9600 1 = 19200 2 = 38400 3 = 76800 4 = 115200
P20.3.3.2 ①	MSTP Device Address	0	127		1	595	
P20.3.3.3 ①	MSTP Instance Number	0	4194302		0	596	
P20.3.3.4	MSTP Comm Timeout	0	60000	ms	10000	598	
P20.3.3.5	MSTP Protocol Status				0	599	0 = Stopped 1 = Operational 2 = Faulted
P20.3.3.6	MSTP Fault Code				0	600	0 = None 1 = Sole Master 2 = Duplicate MAC ID 3 = Baud rate fault
P20.3.3.7	MSTP Fault Response				0	2526	See Par ID 2516
P20.3.3.8 ①	MSTP Max Master	1	127		127	1537	

**Note:** ① Parameter value can only be changed after the drive has stopped.  
 ② Parameter value will be set to be default when changing macros.  
 ③ Input function is level sensed.  
 ④ Input function is edge sensed.  
 ⑤ Input function is edge sensed when using StartP/StopP start logic.

## Chapter 5—Standard application

**Table 40. Terminal: SWD—P20.3.4.**

Code	Parameter	Min.	Max.	Unit	Default	ID	Note
P20.3.4.1	Parameter Access				1	2630	0 = Local Control 1 = Fieldbus
P20.3.4.2 ①	Process Data Access				4	2631	0 = Local Control 1 = Fieldbus 2 = Mixed Interface 4 = NET, Local on Fault 5 = Dual Mode
P20.3.4.3	Fault Situation Counter					2632	
P20.3.4.4	Board Status					2609	
P20.3.4.5	Firmware Version					2610	
P20.3.4.6	Protocol Status					2612	0 = Not Configured 1 = Operational 2 = Diagnostics
P20.3.4.7	Operation Mode					2613	0 = PD2x16Bit Profil 1 = 8Bit Profil 2 = 1-0–A Switch
P20.3.4.8	PDP-Telegram Selection				1	2614	1 = Standard Telegram 1
P20.3.4.9	Fault Counter PDP				0	2615	
P20.3.4.10	Fault Situations Max				8,8	2616	
P20.3.4.11	PDP-Profil Number				809	2618	
P20.3.4.12	PDP-Control Word					2619	
P20.3.4.13	PDP-Status Word				64	2620	
P20.3.4.14	PDP-MaxBlockLength				30	2621	
P20.3.4.15	PDP-NoOfMultiparameter				1	2622	
P20.3.4.16	PDP-MaxLatency				2	2623	
P20.3.4.17	PDP-DO Manufacturer					2624	
P20.3.4.18	PDP-DO Device Type					1451	
P20.3.4.19	PDP-DO FW-Interface					2625	
P20.3.4.20	PDP-DO FW-Year					2626	
P20.3.4.21	PDP-DO FW-DayMonth					2627	
P20.3.4.22	PDP-DO NoOfDOs				1	2628	
P20.3.4.23	PDP-DO Subclass				1	2629	

**Table 41. EtherNet/IP—P20.4.**

Code	Parameter	Min.	Max.	Unit	Default	ID	Note
P20.4.1 ①	IP Address Mode				0	1500	0 = Static IP 1 = DHCP with AutoIP
P20.4.2	Active IP Address					1507	
P20.4.3	Active Subnet Mask					1509	
P20.4.4	Active Default Gateway					1511	
P20.4.5	MAC Address					1513	
P20.4.6 ①	Static IP Address				192.168.1.254	1501	
P20.4.7 ①	Static Subnet Mask				255.255.255.0	1503	
P20.4.8 ①	Static Default Gateway				192.168.1.1	1505	
P20.4.9	Ethernet IP Protocol Status					608	0 = Off 1 = Operational 2 = Faulted
P20.4.10	EIP Fault Response				0	2518	See Par ID 2516

- Note:**
- ① Parameter value can only be changed after the drive has stopped.
  - ② Parameter value will be set to be default when changing macros.
  - ③ Input function is level sensed.
  - ④ Input function is edge sensed.
  - ⑤ Input function is edge sensed when using StartP/StopP start logic.

**Table 42. Modbus TCP—P20.5.**

Code	Parameter	Min.	Max.	Unit	Default	ID	Note
P20.5.1	Connection Limit				5	609	
P20.5.2	Modbus TCP Unit ID				1	610	
P20.5.3	Comm Timeout Modbus TCP	0	60000	ms	10000	611	
P20.5.4	Modbus TCP Protocol Status					612	See Par ID 599
P20.5.5	Modbus TCP Fault Response				0	2517	See Par ID 2516
P20.5.6	Modbus TCP Trusted IP Enable				0	74	See Par ID 2462
P20.5.7	Trusted IP White List				0xC0.0xA8.0x01.0xFF. 0x00.0x00.0x00.0x00.0x0 0.0x00.0x00.0x00	68	

**Table 43. WebUI—P20.6.**

Code	Parameter	Min.	Max.	Unit	Default	ID	Note
P20.6.1	WebUI Protocol Status					2915	See Par ID 608
P20.6.2	WebUI Fault Response				0	2916	See Par ID 2516
P20.6.3	WebUI Communication Timeout	30000	60000	ms	60000	2919	
P20.6.4 ①	WebUI Enable				1	2921	See Par ID 2462

## System

**Table 44. Basic setting—P21.1.**

Code	Parameter	Min.	Max.	Unit	Default	ID	Note
P21.1.1	Language				0	340	0 = English 1 = 中文 2 = Deutsch
P21.1.2 ①	Application					142	0 = Standard 1 = Multi-Pump 2 = Multi-PID 3 = Multi-Purpose
P21.1.3 ①	Parameter Sets					619	0 = No 1 = Reload Defaults 2 = Reload Set 1 3 = Reload Set 2 4 = Store Set 1 5 = Store Set 2 6 = Reset 7 = Reload Defaults VM
P21.1.4	Up To Keypad					620	See Par ID 2118
P21.1.5 ①	Down From Keypad					621	0 = No 1 = All Parameters 2 = All, No Motor 3 = App Parameters
P21.1.6	Parameter Comparison					623	0 = No 1 = Compare with Keypad 2 = Compare with Default 3 = Compare with Set 1 4 = Compare with Set 2
P21.1.7	Password	0	9999		0	624	
P21.1.8	Parameter Lock				0	625	0 = Change Enable 1 = Change Disable
P21.1.9	Multimonitor Set				0	627	See Par ID 625

**Note:** ① Parameter value can only be changed after the drive has stopped.  
 ② Parameter value will be set to be default when changing macros.  
 ③ Input function is level sensed.  
 ④ Input function is edge sensed.  
 ⑤ Input function is edge sensed when using StartP/StopP start logic.

**Table 44. Basic setting—P21.1, continued.**

Code	Parameter	Min.	Max.	Unit	Default	ID	Note
P21.1.10	Default Page				2	628	0 = None 1 = Main Menu 2 = Multi-Monitor 3 = Favorite Menu 4 = Keypad Reference
P21.1.11	Timeout Time	0	65535	s	30	629	
P21.1.12	Contrast Adjust	5	18		12	630	
P21.1.13	Backlight Time	1	65535	min	10	631	
P21.1.14	Fan Control				1	632	0 = Continuous 1 = Temperature 2 = Run Follow
P21.1.15	Keypad ACK Timeout	200	5000	ms	200	633	
P21.1.16	Keypad Retry Number	1	10		5	634	
P21.1.17	Startup Wizard				0	626	0 = Yes 1 = No
P21.1.18	Jog Softkey Hidden				0	2412	See Par ID 2462
P21.1.19	Reverse Softkey Hidden				0	2413	See Par ID 2462
P21.1.20	Output Display Unit				45	2424	0 = % 1 = 1/min 2 = rpm 3 = ppm 4 = pps 5 = l/s 6 = l/min 7 = l/h 8 = kg/s 9 = kg/min 10 = kg/h 11 = m3/s 12 = m3/min 13 = m3/h 14 = m/s 15 = mbar 16 = bar 17 = Pa 18 = kPa 19 = mVS 20 = kW 21 = Deg. C 22 = GPM 23 = gal/s 24 = gal/min 25 = gal/h 26 = lb/s 27 = lb/min 28 = lb/h 29 = CFM 30 = ft3/s 31 = ft3/min 32 = ft3/h 33 = ft/s 34 = in wg 35 = ft wg 36 = PSI 37 = lb/in2 38 = HP 39 = Deg. F 40 = PA 41 = W/C 42 = HG 43 = ft 44 = m 45 = Hz 46 = strokes/min

- Note:**
- ① Parameter value can only be changed after the drive has stopped.
  - ② Parameter value will be set to be default when changing macros.
  - ③ Input function is level sensed.
  - ④ Input function is edge sensed.
  - ⑤ Input function is edge sensed when using StartP/StopP start logic.

**Table 44. Basic setting—P21.1, continued.**

Code	Parameter	Min.	Max.	Unit	Default	ID	Note
P21.1.21	Output Display Unit Min	-60000.00	See Par ID 2425	Varies	0.00	2460	
P21.1.22	Output Display Unit Max	See Par ID 2460	60000.00	Varies	MotorNomFreqMFG	2425	
P21.1.23	Keypad Lock Password	0	9999		0	75	

**Table 45. Version info.—P21.2.**

Code	Parameter	Min.	Max.	Unit	Default	ID	Note
P21.2.1	Keypad Software Version					640	
P21.2.2	Motor Control Software Version					642	
P21.2.3	Application Software Version					644	
P21.2.4	Software Bundle Version					1714	

**Table 46. Application info.—P21.3.**

Code	Parameter	Min.	Max.	Unit	Default	ID	Note
P21.3.1	Brake Chopper Status					646	See Par ID 2118
P21.3.2	Brake Resistor Status					647	See Par ID 2118
P21.3.3	Serial Number					648	
P21.3.4	Power Unit Serial Number					1270	
P21.3.5	Control Unit Serial Number					1276	

**Table 47. User info.—P21.4.**

Code	Parameter	Min.	Max.	Unit	Default	ID	Note
P21.4.1	Real Time Clock				0.0.0.1:1:13	566	
P21.4.2	Daylight Saving				0	582	0 = Off 1 = EU 2 = US
P21.4.3	Total MWh Count			Mwh		601	
P21.4.4	Total Power Day Count					603	
P21.4.5	Total Power Hr Count					606	
P21.4.6	Trip MWh Count			Mwh		604	
P21.4.7	Clear Trip MWh Count					635	See Par ID 2125
P21.4.8	Trip Power Day Count					636	
P21.4.9	Trip Power Hr Count					637	
P21.4.10	Clear Trip Power Count					639	See Par ID 2125

**Table 48. Operate mode—O.**

Code	Parameter	Min.	Max.	Unit	Default	ID	Note
O1	Output Frequency			Hz		1	
O2	Freq Reference			Hz		24	
O3	Motor Speed			rpm		2	
O4	Motor Current			A		3	
O5	Motor Torque			%		4	
O6	Motor Power			%		5	
O7	Motor Voltage			V		6	
O8	DC-link Voltage			V		7	
O9	Unit Temperature			Deg. C		8	
O10	Motor Temperature			%		9	
R12 ②	Keypad Reference	See Par ID 101	See Par ID 102	Hz	0.00	141	

**Note:** ① Parameter value can only be changed after the drive has stopped.  
 ② Parameter value will be set to be default when changing macros.  
 ③ Input function is level sensed.  
 ④ Input function is edge sensed.  
 ⑤ Input function is edge sensed when using StartP/StopP start logic.

# Chapter 6 — Multi-pump and fan control application

## Introduction

The Multi-pump and fan control application is designed to be used in applications where multiple pumps or fan systems are used to maintain a desired flow rate, pressure, or temperature value. It gives the ability to use a single PID loop to control one drive and have auxiliary motors connected via drives or contactors start and stop based off the desired process. It also gives the ability to use a single PID loop and operate using a Multi-Master/Lead-Lag scheme using up to 5 drives. It also provides the ability to auto-change between the multiple motors to keep run times equal. Control-wise it allows for 2 control and reference place selections with 8 digital inputs and 2 analog inputs that are programmable. For monitoring the system and turning on aux motors, there are 3 programmable relay outputs, 1 digital output, and 2 sets of analog outputs that are programmable. The application allows for full customization of the motor control scheme with frequency or speed control along with customizing the V/Hz curve. Drive/motor protections can be customized to defined actions. Below is a list of other features in addition to the standard application features that are available in the multi-pump and fan control application.

Select the Multi-Pump and Fan Application in menu **P21.1.2**.

Multi-pump and fan includes all the functions in standard application and additional functions:

- Damper control
- Fire mode
- Smoke purge mode
- Interlock for motors
- Multi-pump control
- Auto change function
- Bypass
- Real time clock function—Timer
- Real time clock function—Interval
- PM setback
- Two independent set of motor parameter
- PID
- Multi-Master/Lead-Lag

**Note:** When Fire mode is enabled, this causes the drive to ignore any fault and run till its death. Warranty will be none valid in the case this is enabled and the drive causes issues to the system.

## I/O controls

- “Terminal to Function” (TTF) programming

The design behind the programming of the digital inputs in the DG1 drive is to use “Terminal to Function” programming, which is composed of multiple functions that get assigned a digital input to that function. The parameters in the drive are set up with specific functions and by defining the digital input and slot in some cases, depending on which options are available. For use of the drives control board inputs, they will be referred to as DigIN:1 through DigIN:8. When additional option cards are used, they will be defined as DigIN:X:IOY:Z. The X indicates the slot that the card is being installed in, which will be either A or B. The IOY determines the type of card it is, which would be IO1 or IO5. The Z indicates which input is being used on that available option card.

- “Function to Terminal” (FTT) Programming

The design behind the programming of the relay outputs and digital output in the DG1 drive is to use “Function to Terminal” programming. It is composed of a terminal, be it a relay output or a digital output, that is assigned a parameter. Within that parameter, it has different functions that can be set.

The parameters of the Multi-pump and fan control application are explained on **Page 68** of this manual, “Description of Parameters.” The explanations are arranged according to the parameter.

For the DI function, we use terminal programming method to function (TTF), where there is a fixed input that gets programmed to a list of functions. This allows for multiple inputs to be used for different functions. Connecting a certain input with a certain parameter function is done by give a parameter an appropriate value. The value is formed by the location of the input, either being on the standard control board or an external option board and the slot it is located in.

### Force open/force close selection

The Force Open selection would make the selected function always off. Essentially this is a virtual switch that is always open.

The Force Close selection would make the selected function always on. Essentially this is a virtual switch that is always closed.

These options are assigned to a function if we want to force a state without using a hardware input.

#### Example:

If we set Run Enable to Force Closed, the drive is always enabled. If we set the same function to Force Open, the drive would never be Enabled. If a digital input is to be used to activate this Run Enable, the function should be assigned to a hardware input (see below for DIGIN Selections).

### DIGIN selection

This allows assignment of a hardware digital input to a function, this is set in a format of DigIN:X where X is one of the 8 Digital inputs on the main control board.

#### Example:

If we set Run Enable to DigIN:6, the drive will be enabled when digital input 6 (terminal 8) is closed, and would not be enabled when digital input 6 (terminal 8) is open.

### Option board DigIN selection

This allows assignment of a hardware digital input on an option card to a function. This is set in a format of DigIN:Y:IO1:X where Y is the slot the option card is inserted on the main control board and X is the Input on the board and IO1 is the type of option board used.

#### Example:

If we set Run Enable to DigIN:A:IO5:6, the drive will be enabled when digital input 6 is closed on the IO5 option card which is inserted in Slot A, and would not be enabled when digital input 6 on the option card is open.

### Timer channel selection

A Time Channel is a virtual path to link the digital output of a timer function to a digital input function. To utilize this feature a timer or interval would need to be assigned to a time channel 1 through 3, and the input function to be controlled would need to be assigned to the same time channel.

#### Example:

If we set Run Enable to DigIN:TimeChannel1, the drive will be enabled when the timer assigned to Time Channel 1 is active or High, and would not be enabled when the Time Channel is inactive or Low.

### Control examples

#### Single drive

Figure 27. Example of two-pump autochange, main diagram.

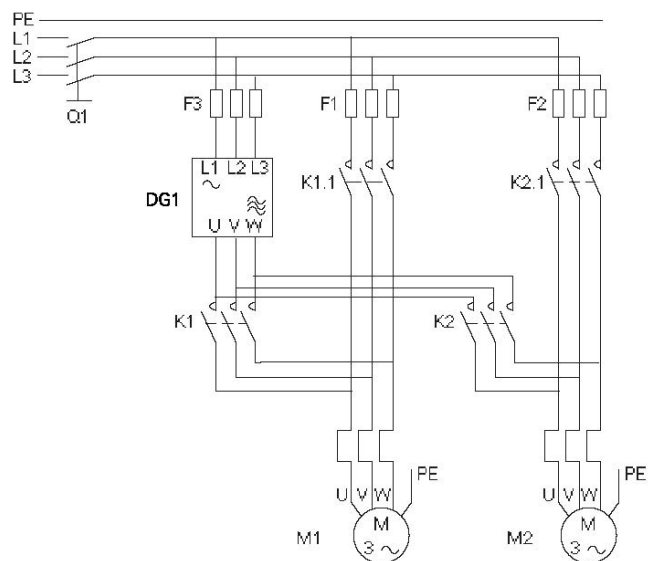


Figure 28. Two-pump autochange system principal control diagram.

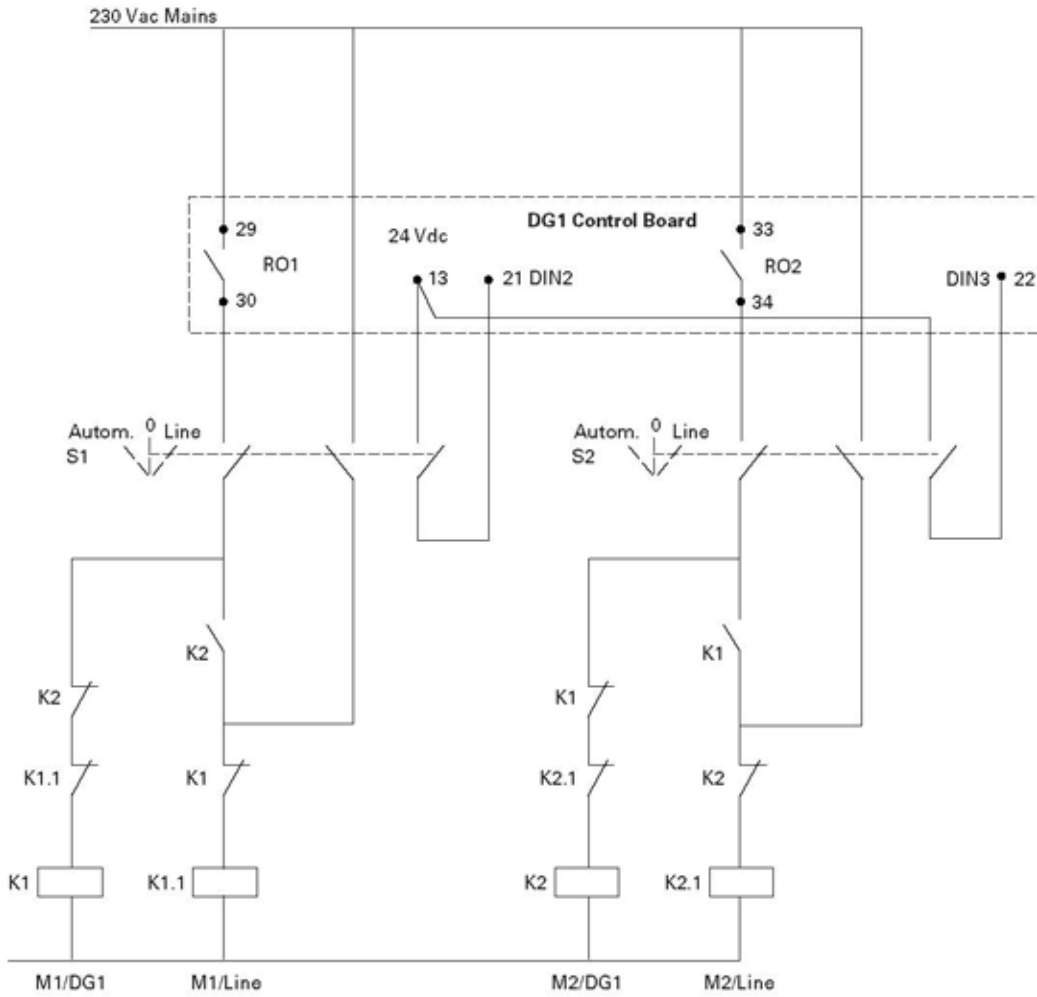




Figure 29. Example of three-pump autochange, main diagram.

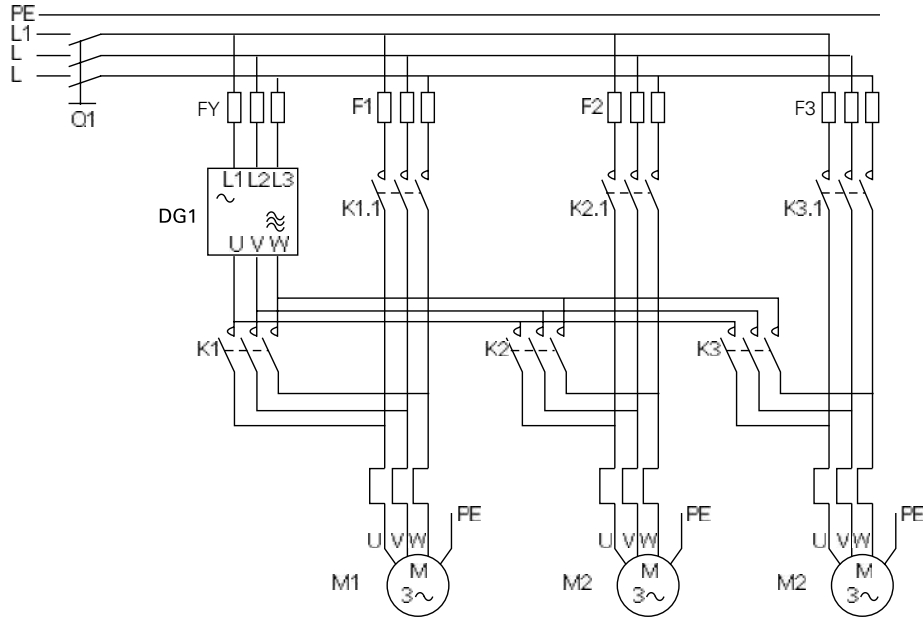


Figure 30. Three-pump autochange system principal control diagram.

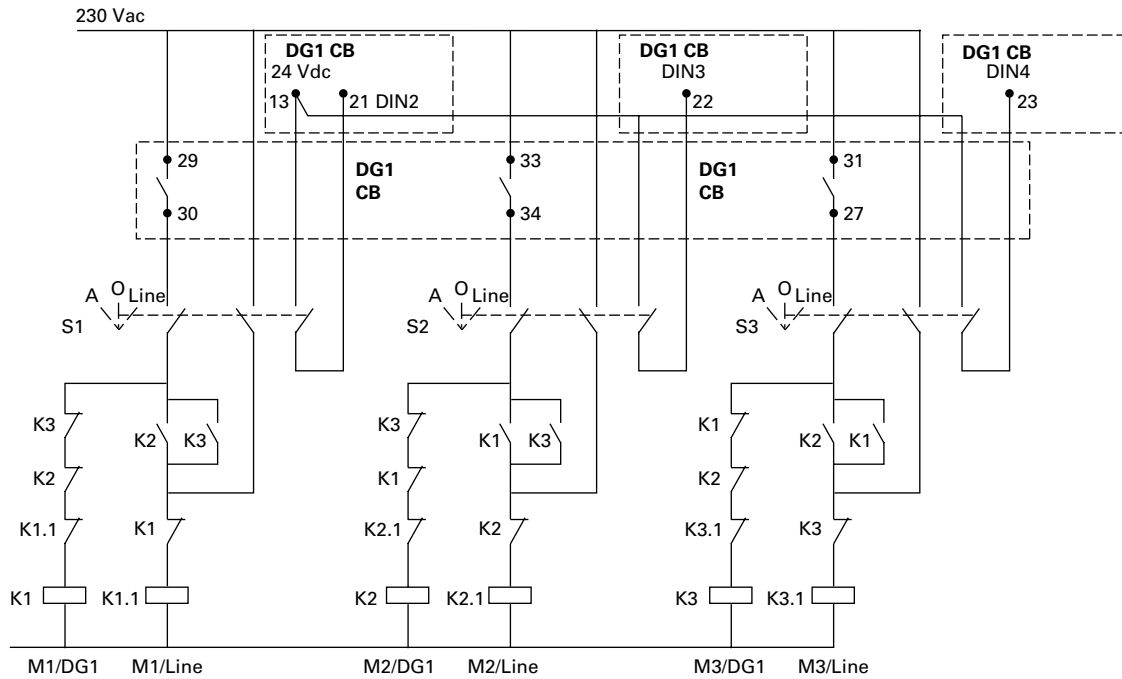


Figure 31. Example of the function of the PFC application with three auxiliary drives.

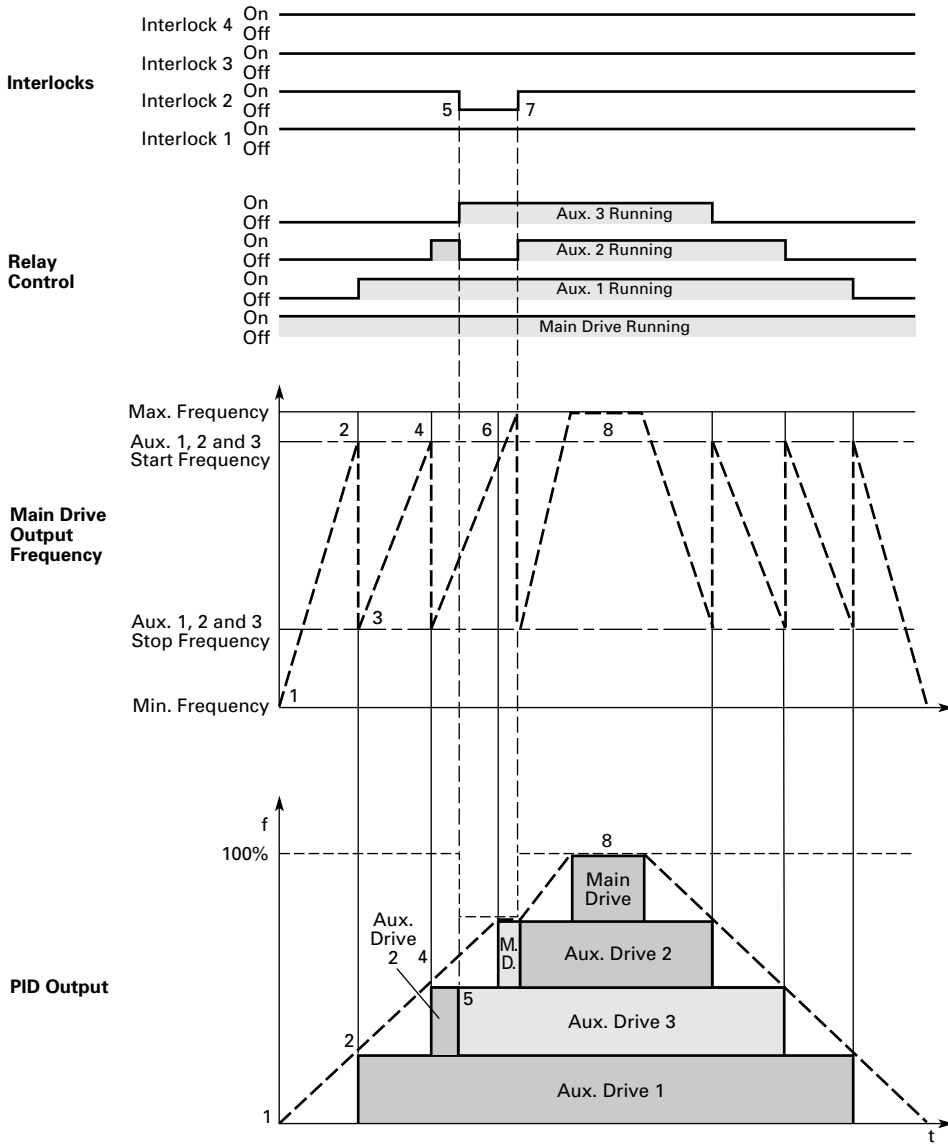


Figure 32. Multi-pump control curve.

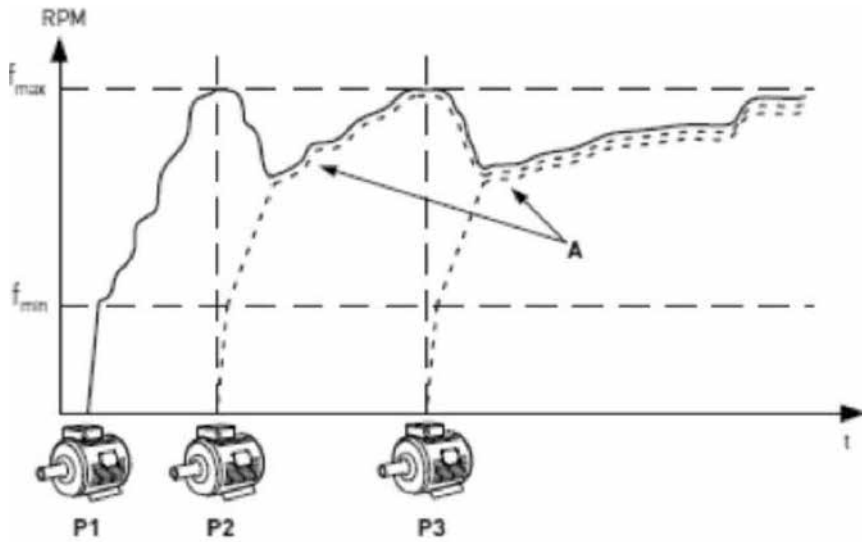


Figure 33. Multi-drive/multi-pump layout.

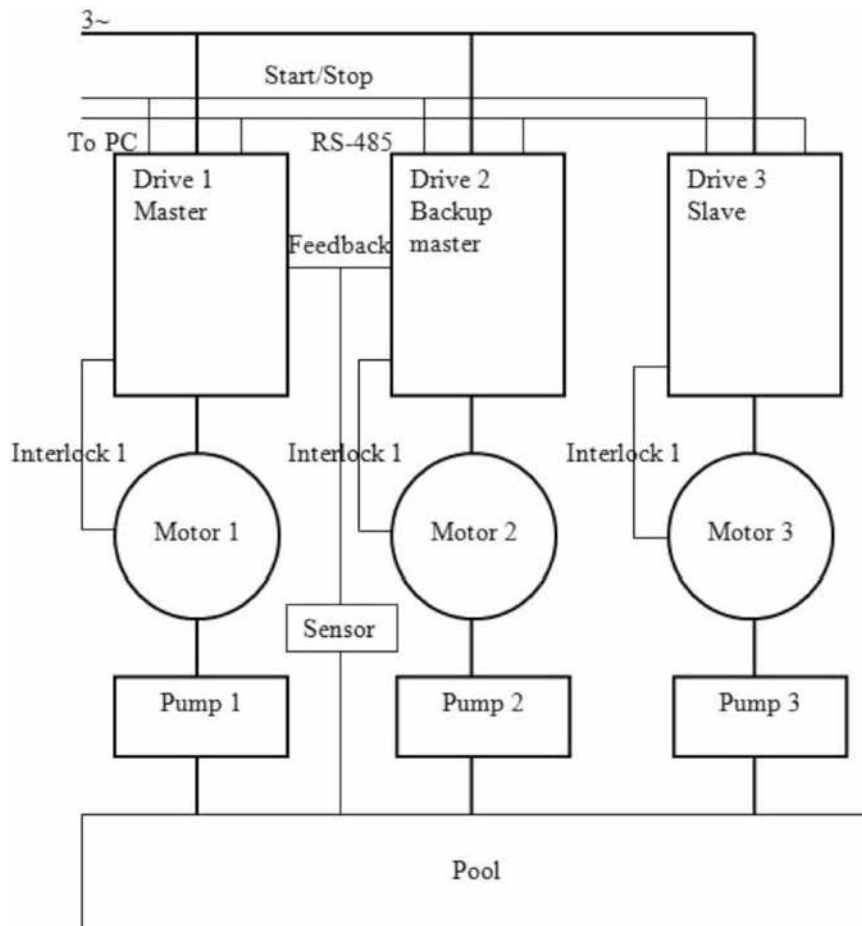


Figure 34. PowerXL drives with 10 V supply with a 0–10 V transducer.

Note

- 10V+/24V Supplies along with grounds for each Master should be connected for the Reference/Setpoint And Start signal if using I/O. (There could be up to 1-5 Masters, anything not considered a master could be a slave with a max of 4 slaves)
- The feedback is wired' to each Master, since it is a voltage signal they are connected in parallel
- Check the Analog input jumpers to be sure they match signal.

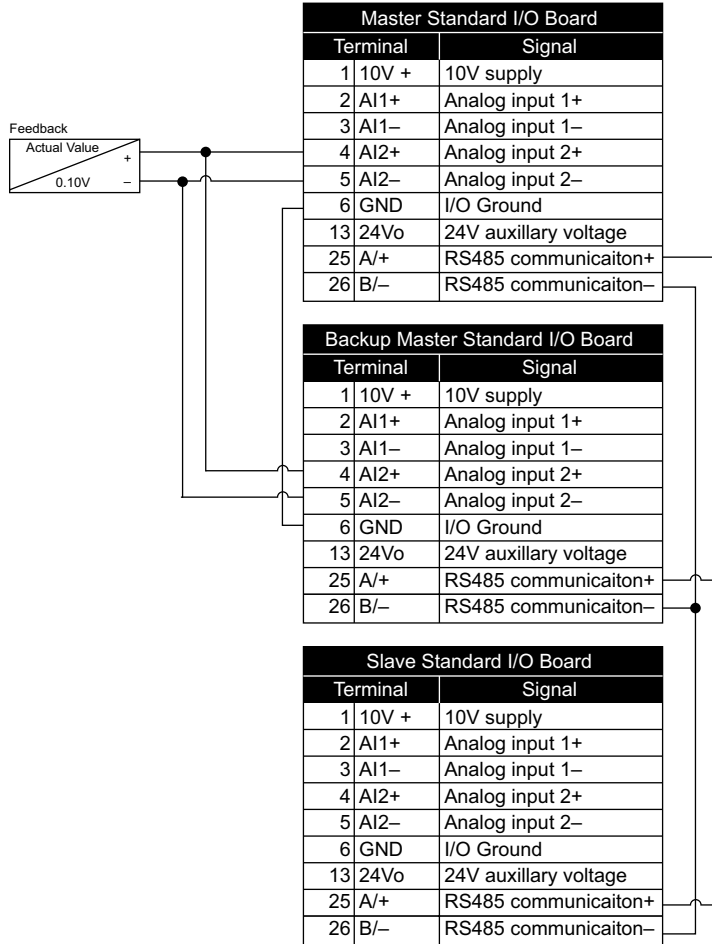


Figure 35. PowerXL drives with 24 V supply with a 4–20 mA transducer.

Note

- 10V+/24V Supplies along with Grounds for each Master should be connected for the Reference/Setpoint And Start signal if using I/O. (There could be up to 1-5 Masters, anything not considered a master could be a slave with a max of 4 slaves)
- The feedback is wired to each Master, since it is a voltage signal they are connected in parallel.
- Check the Analog input jumpers to be sure they match signal.

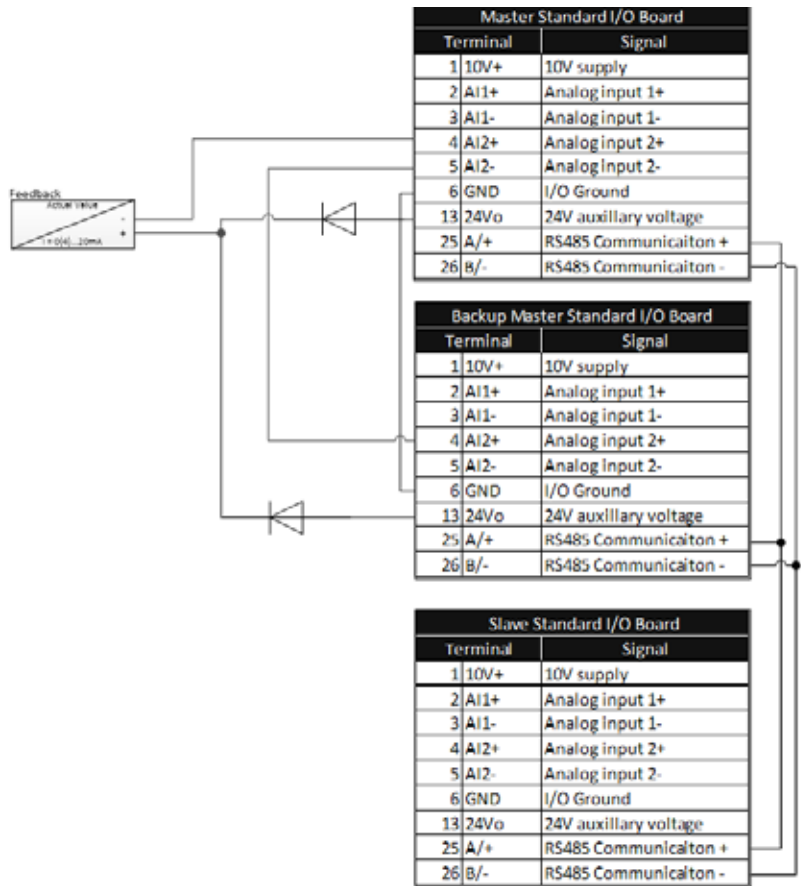


Figure 36. PowerXL drives with ext. supply with a 4–20 mA transducer.

Note  
 - 10V+/24V Supplies along with Grounds for each Master should be connected for the Reference/Setpoint And Start signal if using I/O. (There could be up to 1- 5 Masters, anything not considered a master could be a slave with a max of 4 slaves)  
 -The feedback is wired to each Master, since it is a voltage signal they are connected in parallel.  
 -Check the Analog input jumpers to be sure they match signal.

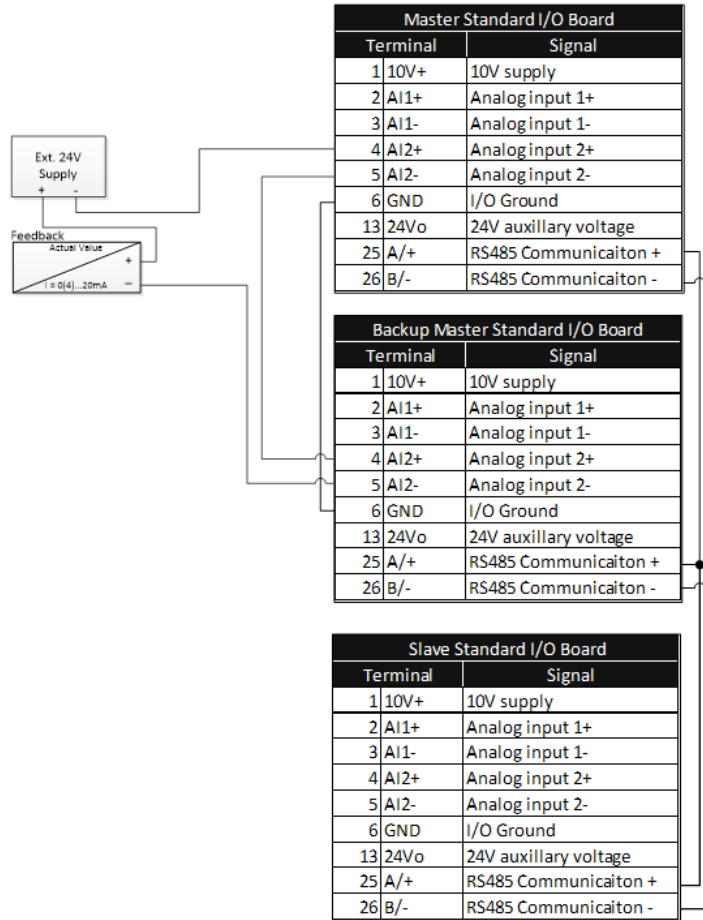
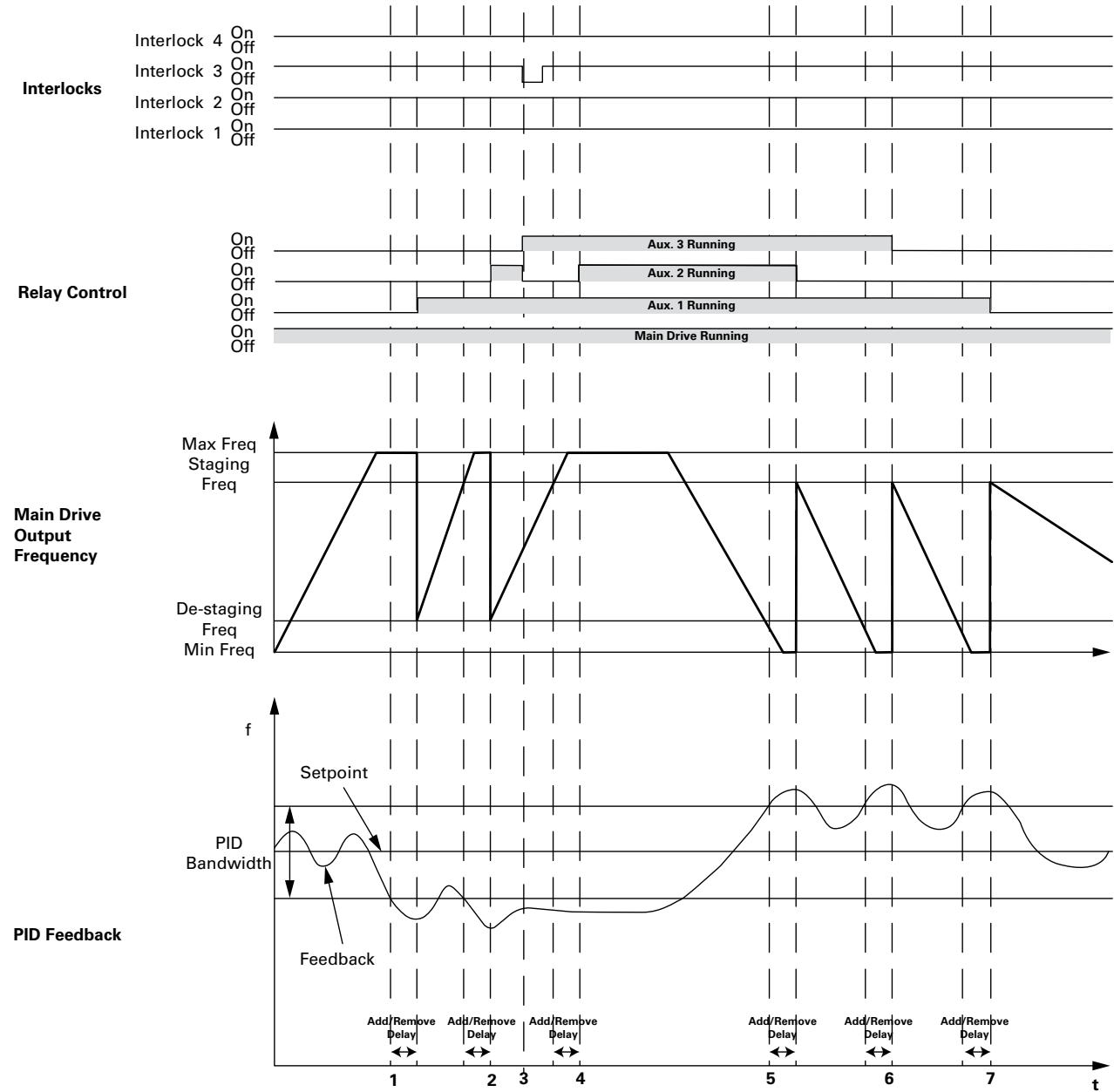


Figure 37. Bandwidth feedback.

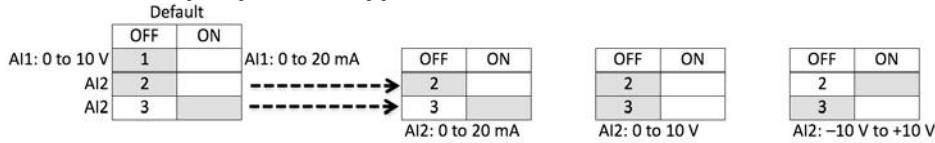


1. Feedback out of bandwidth, output frequency over staging frequency, start delay counter; delay times out, and interlock 2 is OK, add aux. 1 motor by closing its corresponding relay.
2. As above, add aux. 2 motor.
3. Aux. 2's interlock lost, add aux. 3 as backup immediately.
4. Add aux. 2 motor again since its interlock resumed.
5. Feedback out of bandwidth, output frequency below de-staging frequency, start delay counter; delay times out, remove aux. 2 motor first because it's the last one which been added.
6. As above, remove aux. 3 motor.
7. As above, remove aux. 1 motor.

### Control I/O configuration

- Run 240 Vac and 24 Vdc control wiring in separate conduit
- Communication wire to be shielded

**Table 49. Multi-pump and fan application default I/O connection.**



External Wiring	Pin	Signal Name	Signal	Default Setting	Description
	1	+10 V	Ref. Output Voltage	—	10 Vdc Supply Source
	2	AI1+ ⊕	Analog Input 1	0–10 V	Voltage Speed Reference (Programmable to 4 mA to 20 mA)
	3	AI1–	Analog Input 1 Ground	—	Analog Input 1 Common (Ground)
	4	AI2+ ⊕	Analog Input 2	4 mA to 20 mA	Current Speed Reference (Programmable to 0–10 V)
	5	AI2–	Analog Input 2 Ground	—	Analog Input 2 Common (Ground)
	6	GND	I/O Signal Ground	—	I/O Ground for Reference and Control
	7	DIN5	Digital Input 5	Preset Speed B0	Sets frequency output to Preset Speed 1
	8	DIN6	Digital Input 6	Preset Speed B1	Sets frequency output to Preset Speed 2
	9	DIN7	Digital Input 7	Not Used (TI–)	Input forces VFD output to shut off
	10	DIN8	Digital Input 8	Force Remote (TI+)	Input takes VFD from Local to Remote
	11	CMB	DI5 to DI8 Common	Grounded	Allows source input
	12	GND	I/O Signal Ground	—	I/O Ground for Reference and Control
	13	24 V	+24 Vdc Output	—	Control voltage output (100 mA max.)
	14	DO1	Digital Output 1	Ready	Shows the drive is ready to run
	15	24 Vo	+24 Vdc Output	—	Control voltage output (100 mA max.)
	16	GND	I/O Signal Ground	—	I/O Ground for Reference and Control
	17	AO1+	Analog Output 1	Output Frequency	Shows Output frequency to motor 0–60 Hz (4 mA to 20 mA)
	18	AO2+	Analog Output 2	Motor Current	Shows Motor current of motor 0–FLA (4 mA to 20 mA)
	19	24 Vi	+24 Vdc Input	—	External control voltage input
	20	DIN1	Digital Input 1	Run Forward	Input starts drive in forward direction (start enable)
	21	DIN2	Digital Input 2	Run Reverse	Input starts drive in reverse direction (start enable)
	22	DIN3	Digital Input 3	External Fault	Input causes drive to fault
	23	DIN4	Digital Input 4	Fault Reset	Input resets active faults
	24	CMA	DI1 to DI4 Common	Grounded	Allows source input
	25	A/+	RS-485 Signal A	—	Fieldbus Communication (Modbus, BACnet)
	26	B/-	RS-485 Signal B	—	Fieldbus Communication (Modbus, BACnet)
	27	R3NO	Relay 3 Normally Open	At Speed	Relay output 3 shows VFD is at Ref. Frequency
	28	R1NC	Relay 1 Normally Closed	Run	Relay output 1 shows VFD is in a run state
	29	R1CM	Relay 1 Common		
	30	R1NO	Relay 1 Normally Open		
	31	R3CM	Relay 3 Common	At Speed	Relay output 3 shows VFD is at Ref. Frequency
	32	R2NC	Relay 2 Normally Closed	Fault	Relay output 2 shows VFD is in a fault state
	33	R2CM	Relay 2 Common		
	34	R2NO	Relay 2 Normally Open		

**Note:** The above wiring demonstrates a SINK configuration. It is important that CMA and CMB are wired to ground (as shown by dashed line). If a SOURCE configuration is desired, wire 24 V to CMA and CMB and close the inputs to ground. When using the +10 V for AI1, it is important to wire AI1–to ground (as shown by dashed line). If using +10 V for AI1 or AI2, terminals 3, 5, and 6 need to be jumpered together.

⊕ AI1+ and AI2+ support 10K potentiometer.



**Table 50. Drive communication ports.**

<b>Port</b>	<b>Communication</b>
<b>RJ45 Keypad Port</b>	
Upload/Download Parameters	USB to RJ45
Remote Mount Keypad	Ethernet
Upgrade Drive Firmware	USB to RJ45
<b>RJ45 Ethernet Port</b>	
Upload/Download Parameters	Ethernet
Ethernet IP Communications	Ethernet
Modbus TCP Communications	Ethernet
<b>RS-485 Serial Port</b> ①	
Upload/Download Parameters	Two-Wire Twisted Pair
Upgrade Drive Firmware	Two-Wire Twisted Pair
Modbus RTU Communications	Two-Wire Twisted Pair
BACnet MS/TP Communications	Two-Wire Twisted Pair
SmartWire-DT Communications	Two-Wire Shielded Cable

① Shielded wire recommended.

### Pump and fan application—parameters list

On the next pages you will find the lists of parameters within the respective parameter groups. The parameter descriptions are given on **Page 194**, “Description of Parameters.” The descriptions are arranged according to the parameter number.

Column explanations:

- Code = Location indication on the keypad; shows the operator the present parameter number
- Parameter = Name of parameter
- Min = Minimum value of parameter
- Max = Maximum value of parameter
- Unit = Unit of parameter value; given if available
- Default = Value preset by factory
- ID = ID number of the parameter

**Table 51. Monitor—M.**

Code	Parameter	Min.	Max.	Unit	Default	ID	Note
M1	Output Frequency			Hz		1	
M2	Freq Reference			Hz		24	
M3	Motor Speed			rpm		2	
M4	Motor Current			A		3	
M5	Motor Torque			%		4	
M6	Motor Power			%		5	
M7	Motor Voltage			V		6	
M8	DC-link Voltage			V		7	
M9	Unit Temperature			Deg. C		8	
M10	Motor Temperature			%		9	
M12	Analog Input 1			Varies		10	
M13	Analog Input 2			Varies		11	
M14	Analog Output 1			Varies		25	
M15	Analog Output 2			Varies		575	
M16	DI1, DI2, DI3					12	
M17	DI4, DI5, DI6					13	
M18	DI7, DI8					576	
M19	DO1,Virtual RO1,Virtual RO2					14	
M20	RO1, RO2, RO3					557	
M21	TC1, TC2, TC3					558	
M22	Interval 1					559	0 = Inactive 1 = Active
M23	Interval 2					560	See Par ID 559
M24	Interval 3					561	See Par ID 559
M25	Interval 4					562	See Par ID 559
M26	Interval 5					563	See Par ID 559
M27	Timer 1			s	0	569	
M28	Timer 2			s	0	571	
M29	Timer 3			s	0	573	
M30	PID1 Set Point			Varies		16	
M31	PID1 Feedback			Varies		18	
M32	PID1 Error Value			Varies		20	
M33	PID1 Output			%		22	

- Note:**
- ① Parameter value can only be changed after the drive has stopped.
  - ② Parameter value will be set to be default when changing macros.
  - ③ Input function is level sensed.
  - ④ Input function is edge sensed.
  - ⑤ Input function is edge sensed when using StartP/StopP start logic.

**Table 51. Monitor—M, continued.**

Code	Parameter	Min.	Max.	Unit	Default	ID	Note
M34	PID1 Status					23	0 = Stopped 1 = Running 2 = Sleep Mode
M40	Running Motors					26	
M41	PT100 Temperature			Deg. C	1000.0	27	
M42	Latest Fault Code					28	
M43	RTC Battery Status				0	583	0 = Not Installed 1 = Installed 2 = Change Battery 3 = OverVoltage
M44	Instant Motor Power			kW		1686	
M45	Energy Savings			Varies	0.000	2120	
M46	Control Board DIDO Status					2209	
M47	SlotA DIDO Status					2210	
M48	SlotB DIDO Status					2211	
M49	Application Status Word					29	
M50	Standard Status Word					2414	
M51	Output			Varies		2445	
M52	Reference			Varies		2447	
M53	Total MWh Count			Mwh		601	
M54	Total Power Day Count					603	
M55	Total Power Hr Count					606	
M56	Trip MWh Count			Mwh		604	
M57	Trip Power Day Count					636	
M58	Trip Power Hr Count					637	
M59	Total Run time Count			h		2827	
M60	Numbers Of Start					2830	
M61	Trip Run Time Count			h		2829	
M62	FB Status Word					2101	
M63	FB Ctrol Word					2001	
M64	FB Speed Reference	0.00	100.00	%		2003	
M65	Multi-Monitoring				2, 1, 3, 2, 1, 3, 2, 1, 3	1753	

**Note:** ① Parameter value can only be changed after the drive has stopped.  
 ② Parameter value will be set to be default when changing macros.  
 ③ Input function is level sensed.  
 ④ Input function is edge sensed.  
 ⑤ Input function is edge sensed when using StartP/StopP start logic.

## Parameters

**Table 52. Basic parameters—P1.**

Code	Parameter	Min.	Max.	Unit	Default	ID	Note
P1.1	Min Frequency	0.00	See Par ID 102	Hz	0.00	101	
P1.2 ①	Max Frequency	See Par ID 101	400.00	Hz	MaxFreqMFG	102	
P1.3	Accel Time 1	0.1	3000.0	s	3.0	103	
P1.4	Decel Time 1	0.1	3000.0	s	3.0	104	
P1.5 ①	Motor Nom Current	DriveNomCurrCT*1/10	DriveNomCurrCT*2	A	DriveNomCurrCT	486	
P1.6 ①	Motor Nom Speed	300	24000	rpm	MotorNomSpeedMFG	489	
P1.7 ①	Motor PF	0.30	1.00		0.85	490	
P1.8 ①	Motor Nom Voltage	180	690	V	MotorNomVoltMFG	487	
P1.9 ①	Motor Nom Frequency	8.00	400.00	Hz	MotorNomFreqMFG	488	
P1.10	Power Up Local Remote Select				0	1685	0 = Hold Last 1 = Local Control 2 = Remote control
P1.11	Remote 1 Control Place				0	135	0 = I/O Terminal Start 1 1 = Fieldbus 2 = I/O Terminal Start 2 3 = Keypad
P1.12	Local Control Place				0	1695	0 = Keypad 1 = I/O Terminal Start 1 2 = I/O Terminal Start 2 3 = Fieldbus
P1.13	Bumpless Enable				0	2462	0 = Disabled 1 = Enabled
P1.14 ①②	Local Reference				6	136	0 = AI1 1 = AI2 2 = Slot A: AI1 3 = Slot B: AI1 4 = AI1 Joystick 5 = AI2 Joystick 6 = Keypad 7 = Fieldbus Ref 9 = Max Frequency 10 = AI1 + AI2 11 = AI1 - AI2 12 = AI2 - AI1 13 = AI1 * AI2 14 = AI1 or AI2 15 = MIN(AI1,AI2) 16 = MAX(AI1,AI2) 17 = PID1 Control Output
P1.15 ①②	Remote 1 Reference				0	137	See Par ID 136
P1.16 ①	Reverse Enable				1	1679	See Par ID 2462
P1.17	Run Delay Time	0	32500	s	0	2423	
P1.18 ①	HOA Source				0	2465	0 = Disabled 1 = I/O Terminal 2 = Keypad
P1.19 ①	Minimum Run Time	0	32500	s	0	1813	
P1.20	Frequency reference upper limit	See Par ID 101	See Par ID 102	Hz	50.00	2840	
P1.21	Frequency reference upper limit source				0	2841	0 = Not Used 1 = Freq Ref Upper 2 = AI1 3 = AI2

**Note:** ① Parameter value can only be changed after the drive has stopped.  
 ② Parameter value will be set to be default when changing macros.  
 ③ Input function is level sensed.  
 ④ Input function is edge sensed.  
 ⑤ Input function is edge sensed when using StartP/StopP start logic.

## Analog input

**Table 53. Basic setting—P2.1.**

Code	Parameter	Min.	Max.	Unit	Default	ID	Note
P2.1.1	AI Ref Scale Min Value	0.00	See Par ID 145	Hz	0.00	144	
P2.1.2	AI Ref Scale Max Value	See Par ID 144	400.00	Hz	0.00	145	

**Table 54. AI1 settings—P2.2.**

Code	Parameter	Min.	Max.	Unit	Default	ID	Note
P2.2.1	AI1 Mode				1	222	0 = 0–20 mA 1 = 0–10 V
P2.2.2	AI1 Signal Range				0	175	0 = 0–100%/0–20 mA/0–10 V 1 = 20–100%/4–20 mA/2–10 V 2 = Customized
P2.2.3	AI1 Custom Min	0.00	See Par ID 177	%	0.00	176	
P2.2.4	AI1 Custom Max	See Par ID 176	100.00	%	100.00	177	
P2.2.5	AI1 Filter Time	0.00	10.00	s	0.10	174	
P2.2.6	AI1 Signal Invert				0	181	0 = Not Inverted 1 = Inverted
P2.2.7	AI1 Joystick Hyst	0.00	20.00	%	0.00	178	
P2.2.8	AI1 Sleep Limit	0.00	100.00	%	0.00	179	
P2.2.9	AI1 Sleep Delay	0.00	320.00	s	0.00	180	
P2.2.10	AI1 Joystick Offset	-50.00	50.00	%	0.00	133	

**Table 55. AI2 settings—P2.3.**

Code	Parameter	Min.	Max.	Unit	Default	ID	Note
P2.3.1	AI2 Mode				0	223	0 = 0–20 mA 1 = 0–10 V 2 = –10 to +10 V
P2.3.2	AI2 Signal Range				1	183	0 = 0–100%/0–20 mA/ 0–10 V –10 to +10 V 1 = 20–100%/ 4–20 mA/2–10 V/–6 to 10 V 2 = Customized
P2.3.3	AI2 Custom Min	0.00	See Par ID 185	%	0.00	184	
P2.3.4	AI2 Custom Max	See Par ID 184	100.00	%	100.00	185	
P2.3.5	AI2 Filter Time	0.00	10.00	s	0.10	182	
P2.3.6	AI2 Signal Invert				0	189	See Par ID 181
P2.3.7	AI2 Joystick Hyst	0.00	20.00	%	0.00	186	
P2.3.8	AI2 Sleep Limit	0.00	100.00	%	0.00	187	
P2.3.9	AI2 Sleep Delay	0.00	320.00	s	0.00	188	
P2.3.10	AI2 Joystick Offset	-50.00	50.00	%	0.00	134	

- Note:**
- ① Parameter value can only be changed after the drive has stopped.
  - ② Parameter value will be set to be default when changing macros.
  - ③ Input function is level sensed.
  - ④ Input function is edge sensed.
  - ⑤ Input function is edge sensed when using StartP/StopP start logic.

## Chapter 6 — Multi-pump and fan control application

**Table 56. Fine adjust—P2.4.**

Code	Parameter	Min.	Max.	Unit	Default	ID	Note
P2.4.1 ①	Fine Tuning Input				0	2484	0 = Not Used 1 = AI1 2 = AI2 3 = Slot A: AI1 4 = Slot B: AI1 5 = Fieldbus
P2.4.2 ①	Fine Tuning Min	0.0	100.0	%	0.0	2485	
P2.4.3 ①	Fine Tuning Max	0.0	100.0	%	0.0	2486	

**Table 57. Digital input—P3.**

Code	Parameter	Min.	Max.	Unit	Default	ID	Note
P3.1 ①	IO Terminal 1 Start Stop Logic				0	143	0 = Forward - Reverse 1 = Start - Reverse 2 = Start - Enable 3 = 3 Wire Control
P3.2 ②⑤	IO Terminal 1 Start Signal 1				2	190	0 = DigIN:NormallyOpen 1 = DigIN:NormallyClose 2 = DigIN: 1 3 = DigIN: 2 4 = DigIN: 3 5 = DigIN: 4 6 = DigIN: 5 7 = DigIN: 6 8 = DigIN: 7 9 = DigIN: 8 10 = DigIN: A: IO1: 1 11 = DigIN: A: IO1: 2 12 = DigIN: A: IO1: 3 13 = DigIN: A: IO5: 1 14 = DigIN: A: IO5: 2 15 = DigIN: A: IO5: 3 16 = DigIN: A: IO5: 4 17 = DigIN: A: IO5: 5 18 = DigIN: A: IO5: 6 19 = DigIN: B: IO1: 1 20 = DigIN: B: IO1: 2 21 = DigIN: B: IO1: 3 22 = DigIN: B: IO5: 1 23 = DigIN: B: IO5: 2 24 = DigIN: B: IO5: 3 25 = DigIN: B: IO5: 4 26 = DigIN: B: IO5: 5 27 = DigIN: B: IO5: 6 28 = Time Channel 1 29 = Time Channel 2 30 = Time Channel 3 31 = RO1 Function 32 = RO2 Function 33 = RO3 Function 34 = Virtual RO1 Function 35 = Virtual RO2 Function
P3.3 ②⑤	IO Terminal 1 Start Signal 2				3	191	See Par ID 190
P3.4 ①	Thermistor Input Select				0	881	0 = Digital Input 1 = Thermistor Input
P3.5 ②③	Reverse				0	198	See Par ID 190
P3.6 ②③	Ext. Fault 1 NO				4	192	See Par ID 190
P3.7 ②③	Ext. Fault 1 NC				1	193	See Par ID 190
P3.8 ②④	Fault Reset				5	200	See Par ID 190
P3.9 ②③	Run Enable				1	194	See Par ID 190
P3.10 ②③	Preset Speed B0				6	205	See Par ID 190

**Note:** ① Parameter value can only be changed after the drive has stopped.  
 ② Parameter value will be set to be default when changing macros.  
 ③ Input function is level sensed.  
 ④ Input function is edge sensed.  
 ⑤ Input function is edge sensed when using StartP/StopP start logic.

**Table 57. Digital input—P3, continued.**

Code	Parameter	Min.	Max.	Unit	Default	ID	Note
P3.11 ②③	Preset Speed B1				7	206	See Par ID 190
P3.12 ②③	Preset Speed B2				0	207	See Par ID 190
P3.13 ②③	PID1 Control Enable				1	550	See Par ID 190
P3.15 ②③	Accel/Decel Time Set				0	195	See Par ID 190
P3.16 ②③	Accel/Decel Prohibit				0	201	See Par ID 190
P3.17 ②④	No Access To Param				0	215	See Par ID 190
P3.21 ②③	Remote Control				9	196	See Par ID 190
P3.22 ②③	Local Control				0	197	See Par ID 190
P3.23 ②③	Remote 1/2 Select				0	209	See Par ID 190
P3.24 ②③	Second Motor Para Select				0	217	See Par ID 190
P3.25 ②③	Force Bypass				0	218	See Par ID 190
P3.26 ②③	DC Brake Active				0	202	See Par ID 190
P3.27 ②③	Smoke Mode				0	219	See Par ID 190
P3.28 ②③	Fire Mode				0	220	See Par ID 190
P3.29 ②③	Fire Mode Ref 1/2 Select				0	221	See Par ID 190
P3.30 ②③	PID1 Set Point Select				0	351	See Par ID 190
P3.32 ②③	Jog Enable				0	199	See Par ID 190
P3.33 ③	Start Timer 1				0	224	See Par ID 190
P3.34 ③	Start Timer 2				0	225	See Par ID 190
P3.35 ③	Start Timer 3				0	226	See Par ID 190
P3.36 ②③	AI Ref Source Select				0	208	See Par ID 190
P3.37 ②③	Motor Interlock 1				0	210	See Par ID 190
P3.38 ②③	Motor Interlock 2				0	211	See Par ID 190
P3.39 ②③	Motor Interlock 3				0	212	See Par ID 190
P3.40 ②③	Motor Interlock 4				0	213	See Par ID 190
P3.41 ②③	Motor Interlock 5				0	214	See Par ID 190
P3.42 ②③	Ext Fault-AR				1	747	See Par ID 190
P3.43 ②③	Bypass Overload				0	1246	See Par ID 190
P3.44 ②③	Fire Mode Direction Invert				0	2119	See Par ID 190
P3.45 ①	IO Terminal 2 Start Stop Logic				0	2206	See Par ID 143
P3.46 ②⑤	IO Terminal 2 Start Signal 1				2	2207	See Par ID 190
P3.47 ②⑤	IO Terminal 2 Start Signal 2				3	2208	See Par ID 190
P3.48 ②③	Ext. Fault 2 NO				0	2293	See Par ID 190
P3.49 ②③	Ext. Fault 2 NC				1	2294	See Par ID 190
P3.50 ②③	Ext. Fault 3 NO				0	2295	See Par ID 190
P3.51 ②③	Ext. Fault 3 NC				1	2296	See Par ID 190

**Note:** ① Parameter value can only be changed after the drive has stopped.  
 ② Parameter value will be set to be default when changing macros.  
 ③ Input function is level sensed.  
 ④ Input function is edge sensed.  
 ⑤ Input function is edge sensed when using StartP/StopP start logic.

## Chapter 6 — Multi-pump and fan control application

**Table 57. Digital input—P3, continued.**

Code	Parameter	Min.	Max.	Unit	Default	ID	Note
P3.52	Ext. Fault 1 Text					2297	0 = External Fault 1 = Vibration Cut out 2 = High Motor temp 3 = Low Pressure 4 = High Pressure 5 = Low Water 6 = Damper Interlock 7 = Run Enable 8 = Freeze Stat Trip 9 = Smoke Detect 10 = Seal Leakage 11 = Rod Breakage 12 = Torque Limit
P3.53	Ext. Fault 2 Text				1	2298	See Par ID 2297
P3.54	Ext. Fault 3 Text				2	2299	See Par ID 2297
P3.55 ②④	Parameter Set1/2 Sel				0	2312	See Par ID 190
P3.56 ②③	Deragging Enable				0	2394	See Par ID 190
P3.57 ②③	HOA On/Off				1	2395	See Par ID 190
P3.58 ③	Multi-pump Mode 1/2 Select				0	2658	See Par ID 190
P3.59 ②③	OP Cont Interlock NO				4	2801	See Par ID 190
P3.60 ②③	OP Cont Interlock NC				1	2802	See Par ID 190
P3.61 ③	CP Interlock NC				1	2894	See Par ID 190

**Note:** ① Parameter value can only be changed after the drive has stopped.  
 ② Parameter value will be set to be default when changing macros.  
 ③ Input function is level sensed.  
 ④ Input function is edge sensed.  
 ⑤ Input function is edge sensed when using StartP/StopP start logic.



**Table 58. Analog output—P4.**

Code	Parameter	Min.	Max.	Unit	Default	ID	Note
P4.1	AO1 Mode				0	227	See Par ID 222
P4.2 ②	AO1 Function				1	146	0 = Not Used 1 = Output Frequency 2 = Freq Reference 3 = Motor Speed 4 = Motor Current 5 = Motor Torque (0-Nom) 6 = Motor Power 7 = Motor Voltage 8 = DC-Bus Voltage 9 = PID1 Setpoint 10 = PID1 Feedback 1 11 = PID1 Feedback 2 12 = PID1 Control Error Value 13 = PID1 Control Output 19 = AI1 20 = AI2 21 = Output Freq (-2-+2N) 22 = Motor Torque (-2-+2N) 23 = Motor Power (-2-+2N) 24 = PT100 Temperature 25 = FB Process Data Input 1 26 = FB Process Data Input 2 27 = FB Process Data Input 3 28 = FB Process Data Input 4 29 = FB Process Data Input 5 30 = FB Process Data Input 6 31 = FB Process Data Input 7 32 = FB Process Data Input 8 33 = SlotA PT100 Temp Channel 1 34 = SlotA PT100 Temp Channel 2 35 = SlotA PT100 Temp Channel 3 36 = SlotB PT100 Temp Channel 1 37 = SlotB PT100 Temp Channel 2 38 = SlotB PT100 Temp Channel 3 39 = User Defined Output 40 = Motor Current (-2-+2N)
P4.3	AO1 Minimum				1	149	0 = 0 V / 0 mA 1 = 2 V / 4 mA
P4.4	AO1 Filter Time	0.00	10.00	s	1.00	147	
P4.5	AO1 Scale	10	1000	%	100	150	
P4.6	AO1 Inversion				0	148	See Par ID 181
P4.7	AO1 Offset	-100.00	100.00	%	0.00	173	
P4.8	AO2 Mode				0	228	See Par ID 222
P4.9 ②	AO2 Function				4	229	See Par ID 146
P4.10	AO2 Minimum				1	232	See Par ID 149
P4.11	AO2 Filter Time	0.00	10.00	s	1.00	230	
P4.12	AO2 Scale	10	1000	%	100	233	
P4.13	AO2 Inversion				0	231	See Par ID 181
P4.14	AO2 Offset	-100.00	100.00	%	0.00	234	

**Note:** ① Parameter value can only be changed after the drive has stopped.  
 ② Parameter value will be set to be default when changing macros.  
 ③ Input function is level sensed.  
 ④ Input function is edge sensed.  
 ⑤ Input function is edge sensed when using StartP/StopP start logic.

**Table 59. Digital output—P5.**

Code	Parameter	Min.	Max.	Unit	Default	ID	Note
P5.1 ②	DO1 Function				1	151	0 = Not Used 1 = Ready 2 = Run 3 = Fault 4 = Fault Invert 5 = Warning 6 = Reversed 7 = At Speed 8 = Zero Frequency 9 = Freq Limit 1 Superv 10 = Freq Limit 2 Superv 11 = PID1 Superv 13 = OverHeat Fault 14 = OverCurrent Regular 15 = OverVoltage Regular 16 = UnderVoltage Regular 17 = 4mA Ref Fault/Warning 20 = Torq Limit Superv 21 = Ref Limit Superv 22 = Control from I/O 23 = Un-Requested Rotation Direction 24 = Thermistor Fault Output 25 = Fire Mode 26 = In Bypass Mode 27 = Ext Fault/Warning 28 = Remote Control 29 = Jog Speed Select 30 = Motor Therm Protection 31 = FB Digital Input 1 32 = FB Digital Input 2 33 = FB Digital Input 3 34 = FB Digital Input 4

- Note:**
- ① Parameter value can only be changed after the drive has stopped.
  - ② Parameter value will be set to be default when changing macros.
  - ③ Input function is level sensed.
  - ④ Input function is edge sensed.
  - ⑤ Input function is edge sensed when using StartP/StopP start logic.

**Table 59. Digital output—P5, continued.**

Code	Parameter	Min.	Max.	Unit	Default	ID	Note
P5.1 ②, continued	DO1 Function				1	151	35 = Damper Control 36 = TC1 Status 37 = TC2 Status 38 = TC3 Status 39 = In E-Stop 40 = Power Limit Superv 41 = Temp Limit Superv 42 = Analog Input Superv 43 = Motor 1 Control 44 = Motor 2 Control 45 = Motor 3 Control 46 = Motor 4 Control 47 = Motor 5 Control 49 = PID1 Sleep 51 = Motor Current 1 Supv 52 = Motor Current 2 Supv 53 = Second AI Limit Supv 54 = DC Charge Switch Close 55 = Preheat Active 56 = Cold Weather Active 57 = Prime Pump Active 58 = 2th Stage Ramp Frequency Active 59 = STO Fault Output 60 = Run Bypass/Drive 61 = Bypass Overload 62 = Bypass Run 63 = Auto Local On COM Fault 64 = FieldBus RTU Fault 65 = FieldBus TCP Fault 66 = FieldBus MSTP Fault 67 = FieldBus EIP Fault 68 = FieldBus SlotA Fault 69 = Fieldbus SlotB Fault 70 = FieldBus SWD Fault 71 = Jockey Pump Active 72 = Lube Pump Active 73 = PID1 Low Feedback 74 = PID1 High Feedback 77 = Master in MPFC 78 = CP Interlock Fault
P5.2 ②	RO1 Function				2	152	See Par ID 151
P5.3 ②	RO2 Function				3	153	See Par ID 151
P5.4 ②	RO3 Function				7	538	See Par ID 151
P5.5 ②	Virtual RO1 Function				0	2463	See Par ID 151
P5.6 ②	Virtual RO2 Function				0	2464	See Par ID 151
P5.7 ②	Freq Limit 1 Supv				0	154	0 = No Limit 1 = Low Limit Superv 2 = High Limit Superv
P5.8	Freq Limit 1 Supv Val	0.00	See Par ID 102	Hz	0.00	155	
P5.9 ②	Freq Limit 2 Supv				0	157	0 = No Limit 1 = Low Limit Superv 2 = High Limit Superv
P5.10	Freq Limit 2 Supv Val	0.00	See Par ID 102	Hz	0.00	158	
P5.11 ②	Torque Limit Supv				0	159	0 = No Limit 1 = Low Limit Superv 2 = High Limit Superv
P5.12 ②	Torque Limit Supv Val	-1000.0	1000.0	%	100.0	160	
P5.13	Ref Limit Supv				0	161	0 = No Limit 1 = Low Limit Superv 2 = High Limit Superv
P5.14	Ref Limit Supv Val	0.00	See Par ID 102	Hz	0.00	162	

**Note:** ① Parameter value can only be changed after the drive has stopped.  
 ② Parameter value will be set to be default when changing macros.  
 ③ Input function is level sensed.  
 ④ Input function is edge sensed.  
 ⑤ Input function is edge sensed when using StartP/StopP start logic.

## Chapter 6 — Multi-pump and fan control application

**Table 59. Digital output—P5, continued.**

Code	Parameter	Min.	Max.	Unit	Default	ID	Note
P5.17	Temp Limit Supv				0	165	See Par ID 161
P5.18	Temp Limit Supv Val	-10.0	75.0	Deg. C	40.0	166	
P5.19	Power Limit Supv				0	167	See Par ID 161
P5.20	Power Limit Supv Val	-200.0	200.0	%	0.0	168	
P5.21	AI Supv Select				0	170	0 = AI1 1 = AI2
P5.22	AI Limit Supv				0	171	See Par ID 161
P5.23	AI Limit Supv Val	0.00	100.00	%	0.00	172	
P5.24	PID1 Superv Enable				0	1346	See Par ID 2462
P5.25	PID1 Superv Upper Limit	See Par ID 1298	See Par ID 1300	Varies	0.00	1347	
P5.26	PID1 Superv Lower Limit	See Par ID 1298	See Par ID 1300	Varies	0.00	1349	
P5.27	PID1 Superv Delay	0	3000	s	0	1351	
P5.32	RO1 On Delay	0.0	320.0	s	0.0	2112	
P5.33	RO1 Off Delay	0.0	320.0	s	0.0	2113	
P5.34	RO2 On Delay	0.0	320.0	s	0.0	2114	
P5.35	RO2 Off Delay	0.0	320.0	s	0.0	2115	
P5.36	RO3 On Delay	0.0	320.0	s	0.0	2116	
P5.37	RO3 Off Delay	0.0	320.0	s	0.0	2117	
P5.38	RO3 Reverse				0	2118	0 = No 1 = Yes
P5.39 ②	Motor Current 1 Supv				0	2189	See Par ID 159
P5.40	Motor Current 1 Supv Value	0.0	DriveNomCurrCT*2	A	DriveNomCurrCT	2190	
P5.41 ②	Motor Current 2 Supv				0	2191	See Par ID 159
P5.42	Motor Current 2 Supv Value	0.0	DriveNomCurrCT*2	A	DriveNomCurrCT	2192	
P5.43	Second AI Supv Select				0	2193	See Par ID 170
P5.44	Second AI Limit Supv				0	2194	See Par ID 161
P5.45	Second AI Limit Supv Val	0.00	100.00	%	0.00	2195	
P5.46	Motor Current 1 Supv Hyst	0.1	1.0	A	0.1	2196	
P5.47	Motor Current 2 Supv Hyst	0.1	1.0	A	0.1	2197	
P5.48	AI Supv Hyst	1.00	10.00	%	1.00	2198	
P5.49	Second AI Supv Hyst	1.00	10.00	%	1.00	2199	
P5.50	Freq Limit 1 Supv Hyst	0.10	1.00	Hz	0.10	2200	
P5.51	Freq Limit 2 Supv Hyst	0.10	1.00	Hz	0.10	2201	
P5.52	Torque Limit Supv Hyst	1.0	5.0	%	1.0	2202	
P5.53	Ref Limit Supv Hyst	0.10	1.00	Hz	0.10	2203	
P5.54	Temp Limit Supv Hyst	1.0	10.0	Deg. C	1.0	2204	
P5.55	Power Limit Supv Hyst	0.1	10.0	%	0.1	2205	
P5.56	Virtual RO1 On Delay	0.0	320.0	s	0.0	2848	
P5.57	Virtual RO1 Off Delay	0.0	320.0	s	0.0	2849	
P5.58	Virtual RO2 On Delay	0.0	320.0	s	0.0	2850	
P5.59	Virtual RO2 Off Delay	0.0	320.0	s	0.0	2851	

- Note:**
- ① Parameter value can only be changed after the drive has stopped.
  - ② Parameter value will be set to be default when changing macros.
  - ③ Input function is level sensed.
  - ④ Input function is edge sensed.
  - ⑤ Input function is edge sensed when using StartP/StopP start logic.

**Table 60. Drive control—P7.**

Code	Parameter	Min.	Max.	Unit	Default	ID	Note
P7.1	Remote 2 Control Place				1	138	See Par ID 135
P7.2 ①②	Remote 2 Reference				7	139	See Par ID 136
P7.3	Keypad Reference	See Par ID 101	See Par ID 102	Hz	0.00	141	
P7.4	Keypad Direction				0	116	0 = Forward 1 = Reverse
P7.5	Keypad Stop				1	114	0 = Enabled-Keypad Operation 1 = Always Enabled
P7.6	Jog Reference	0.00	See Par ID 102	Hz	5.00	117	
P7.9	Start Mode				0	252	0 = Ramp 1 = Flying Start From Stop Frequency 2 = Flying Start From Max Frequency
P7.10	Stop Mode					2531	0 = Coasting 1 = Ramp
P7.11	Ramp 1 Shape	0.0	10.0	s	0.0	247	
P7.12	Ramp 2 Shape	0.0	10.0	s	0.0	248	
P7.13	Accel Time 2	0.1	3000.0	s	10.0	249	
P7.14	Decel Time 2	0.1	3000.0	s	10.0	250	
P7.15	Skip F1 Low Limit	0.00	See Par ID 257	Hz	0.00	256	
P7.16	Skip F1 High Limit	See Par ID 256	400.00	Hz	0.00	257	
P7.17	Skip F2 Low Limit	0.00	See Par ID 259	Hz	0.00	258	
P7.18	Skip F2 High Limit	See Par ID 258	400.00	Hz	0.00	259	
P7.19	Skip F3 Low Limit	0.00	See Par ID 261	Hz	0.00	260	
P7.20	Skip F3 High Limit	See Par ID 260	400.00	Hz	0.00	261	
P7.21	Skip Range Ramp Factor	0.1	10.0		1.0	264	
P7.22	Power Loss Function				0	267	0 = Disabled 1 = Decel Mode 2 = Coast Mode
P7.23	Power Loss Time	0.3	5.0	s	2.0	268	
P7.24	Currency				0	2122	0 = \$ 1 = £ 2 = € 3 = ¥ 4 = Rs 5 = R\$ 6 = Fr 7 = kr
P7.25	Energy Cost			Varies	0.00	2123	
P7.26	Data Type				0	2124	0 = Cumulative 1 = Daily Avg 2 = Weekly Avg 3 = Monthly Avg 4 = Yearly Avg
P7.27	Energy Savings Reset					2125	0 = Not Reset 1 = Reset
P7.28①	2nd Stage Ramp Frequency	See Par ID 101	See Par ID 102	Hz	30.00	2444	
P7.29	Change PhaseSequence Motor				0	2515	0 = Change Disable 1 = Change Enable
P7.30	Run Remove Stop Mode				0	2667	See Par ID 253

**Note:** ① Parameter value can only be changed after the drive has stopped.  
 ② Parameter value will be set to be default when changing macros.  
 ③ Input function is level sensed.  
 ④ Input function is edge sensed.  
 ⑤ Input function is edge sensed when using StartP/StopP start logic.

## Chapter 6 — Multi-pump and fan control application

**Table 61. Motor Control—P8.**

Code	Parameter	Min.	Max.	Unit	Default	ID	Note
P8.1 ①②	Motor Control Mode				0	287	0 = Freq Control 1 = Speed Control
P8.2 ①	Current Limit	DriveNomCurrCT*1/10	DriveNomCurrCT*2	A	DriveNomCurrVT	107	
P8.3 ①	V/Hz Optimization				0	109	See Par ID 2462
P8.4 ①	V/Hz Ratio				0	108	0 = Linear 1 = Squared 2 = Programmable 3 = Linear + Flux Optimization
P8.5 ①	Field Weakening Point	8.00	400.00	Hz	FieldWeakPointMFG	289	
P8.6 ①	Voltage at FWP	10.00	200.00	%	100.00	290	
P8.7 ①	V/Hz Mid Frequency	0.00	See Par ID 289	Hz	VHzCurveMidFreqMFG	291	
P8.8 ①	V/Hz Mid Voltage	0.00	100.00	%	100.00	292	
P8.9 ①	Zero Frequency Voltage	0.00	40.00	%	0.00	293	
P8.10	Switching Frequency	MinSwitchFreq	MaxSwitchFreq	kHz	DefaultSwitchFreqCT	2522	
P8.11	Sine Filter Enable				0	1665	See Par ID 2462
P8.12 ①	OverVoltage Control				3	297	0 = Disabled 1 = REF + 8Hz 2 = Max Freq 3 = Max Freq + 8Hz
P8.14 ②	Identification				0	299	0 = No Action 1 = Identification Only Stator Resistor 2 = Identification with Run 3 = Identification No Run 4 = Identification Only Inertia
P8.17	Frequency Ramp Out FilterTime Constant	0	3000	ms	0	1585	
P8.50 ①	Stator Resistor	0.001	65.535	ohm	0.001	771	
P8.59	VF Stable Kd	0	3000	%	100	1656	
P8.60	VF Stable Kq	0	3000	%	100	1657	
P8.61 ①	Overmodulation Enable				0	2835	See Par ID 2462
P8.71	Slip Compensation Coefficient	0	500	%	100	1664	

**Table 62. Protections—P9.**

Code	Parameter	Min.	Max.	Unit	Default	ID	Note
P9.1 ①	4mA Input Fault				0	306	0 = No Action 1 = Warning 2 = Warning: Previous Freq 3 = Warning: Preset Freq 4 = Fault 5 = Fault, Coast
P9.2 ①	4mA Fault Frequency	0.00	See Par ID 102	Hz	0.00	331	
P9.3 ①	External Fault				2	307	0 = No Action 1 = Warning 2 = Fault 3 = Fault, Coast
P9.4 ①	Input Phase Fault				2	332	0 = No Action 1 = Warning 2 = Fault 3 = Fault, Coast 4 = Single Phase Power Limit
P9.5 ①	Uvolt Fault Response				2	330	See Par ID 307
P9.6 ①	Output Phase Fault				2	308	See Par ID 307

**Note:** ① Parameter value can only be changed after the drive has stopped.  
 ② Parameter value will be set to be default when changing macros.  
 ③ Input function is level sensed.  
 ④ Input function is edge sensed.  
 ⑤ Input function is edge sensed when using StartP/StopP start logic.

**Table 62. Protections—P9, continued.**

Code	Parameter	Min.	Max.	Unit	Default	ID	Note
P9.7 ①	Ground Fault				2	309	See Par ID 307
P9.8 ①	Motor Thermal Protection				2	310	See Par ID 307
P9.9	Motor Thermal FO Current	0.0	150.0	%	100.0	311	
P9.11 ①	Stall Protection				0	313	See Par ID 307
P9.12	Stall Current Limit	0.1	ActiveMotor NomCurr*2	A	ActiveMotor NomCurr*13/10	314	
P9.13	Stall Time Limit	1.0	120.0	s	15.0	315	
P9.14	Stall Frequency Limit	1.00	See Par ID 102	Hz	25.00	316	
P9.15 ①	Underload Protection				0	317	See Par ID 307
P9.16	Underload Fnom Torque	10.0	150.0	%	50.0	318	
P9.17	Underload FO Torque	5.0	150.0	%	10.0	319	
P9.18	Underload Time Limit	2.00	600.00	s	20.00	320	
P9.19 ①	Thermistor Fault Response				2	333	See Par ID 307
P9.20	Line Start Lockout				2	750	0 = Disabled, No Change 1 = Enable, No Change 2 = Disabled, Changed 3 = Enable, Changed
P9.21 ①	Fieldbus Fault Response				2	334	0 = No Action 1 = Warning 2 = Fault 3 = Fault, Coast 4 = Warning, Coast 5 = Warning, Auto Switch To Local 6 = Warning, Auto Switch To Preset Speed 1
P9.22 ①	OPTCard Fault Response				2	335	See Par ID 307
P9.23 ①	Unit Under Temp Prot				2	1564	See Par ID 307
P9.24	AR Wait Time	1.00	300.00	s	1.00	321	
P9.25	AR Trail Time	0.00	600.00	s	30.00	322	
P9.26	AR Start Function				0	323	0 = Flying Start From Stop Frequency 1 = Ramp 2 = Flying Start From Max Frequency
P9.27	Undervoltage Attempts	0	10		1	324	
P9.28	OverVoltage Attempts	0	10		1	325	
P9.29	OverCurrent Attempts	0	3		1	326	
P9.30	4mA Fault Attempts	0	10		1	327	
P9.31	Motor Temp Fault Attempts	0	10		1	329	
P9.32	External Fault Attempts	0	10		1	328	
P9.33	Underload Attempts	0	10		1	336	
P9.34 ①	RTC Fault				1	955	See Par ID 307
P9.35 ①	PT100 Fault Response				2	337	See Par ID 307
P9.36 ①	Replace Battery Fault Response				1	1256	See Par ID 307
P9.37 ①	Replace Fan Fault Response				1	1257	See Par ID 307

**Note:** ① Parameter value can only be changed after the drive has stopped.  
 ② Parameter value will be set to be default when changing macros.  
 ③ Input function is level sensed.  
 ④ Input function is edge sensed.  
 ⑤ Input function is edge sensed when using StartP/StopP start logic.

## Chapter 6 — Multi-pump and fan control application

**Table 62. Protections—P9, continued.**

Code	Parameter	Min.	Max.	Unit	Default	ID	Note
P9.38 ①	IP Address Conflict Resp				1	1678	See Par ID 307
P9.39	Cold Weather Mode				0	2126	See Par ID 2462
P9.40	Cold Weather Volt. Level	0.0	20.0	%	2.0	2127	
P9.41	Cold Weather Time Out	0	10	min	3	2128	
P9.42	Cold Weather Password					2129	
P9.43	Under Temp Fault Override					2130	See Par ID 2118
P9.44	Ground Fault Limit	0	30	%	15	2158	
P9.45 ①	Keypad Comm Fault Response				2	2157	See Par ID 307
P9.46	Preheat Mode				0	2159	See Par ID 2462
P9.47 ②	Preheat Control Source				31	2160	0 = DigIN:NormallyOpen 1 = DigIN:NormallyClose 2 = DigIN: 1 3 = DigIN: 2 4 = DigIN: 3 5 = DigIN: 4 6 = DigIN: 5 7 = DigIN: 6 8 = DigIN: 7 9 = DigIN: 8 10 = DigIN: A: IO1: 1 11 = DigIN: A: IO1: 2 12 = DigIN: A: IO1: 3 13 = DigIN: A: IO5: 1 14 = DigIN: A: IO5: 2 15 = DigIN: A: IO5: 3 16 = DigIN: A: IO5: 4 17 = DigIN: A: IO5: 5 18 = DigIN: A: IO5: 6 19 = DigIN: B: IO1: 1 20 = DigIN: B: IO1: 2 21 = DigIN: B: IO1: 3 22 = DigIN: B: IO5: 1 23 = DigIN: B: IO5: 2 24 = DigIN: B: IO5: 3 25 = DigIN: B: IO5: 4 26 = DigIN: B: IO5: 5 27 = DigIN: B: IO5: 6 28 = Time Channel 1 29 = Time Channel 2 30 = Time Channel 3 31 = Drive Temperature 32 = SlotA PT100 Temp Channel 1 33 = SlotA PT100 Temp Channel 2 34 = SlotA PT100 Temp Channel 3 35 = SlotA Max PT100 Temp 36 = SlotB PT100 Temp Channel 1 37 = SlotB PT100 Temp Channel 2 38 = SlotB PT100 Temp Channel 3 39 = SlotB Max PT100 Temp 40 = SlotA and SlotB Max PT100 Temp
P9.48	Preheat Enter Temp	-20.0	20.0	Deg. C	10.0	2161	

- Note:**
- ① Parameter value can only be changed after the drive has stopped.
  - ② Parameter value will be set to be default when changing macros.
  - ③ Input function is level sensed.
  - ④ Input function is edge sensed.
  - ⑤ Input function is edge sensed when using StartP/StopP start logic.



**Table 62. Protections—P9, continued.**

Code	Parameter	Min.	Max.	Unit	Default	ID	Note
P9.49	Preheat Quit Temp	-10.0	40.0	Deg. C	20.0	2162	
P9.50	Preheat Output Volt	0.0	20.0	%	2.0	2163	
P9.51 ①	PID Feedback AI Loss Response				0	2401	0 = No Action 1 = Warning 2 = Fault 3 = Warning: Preset Freq 4 = Warning: Analog->Net
P9.52 ②	PID Feedback AI Loss Pre Freq	0.00	400.00	Hz	0.00	2402	
P9.53	PID Feedback AI Loss Pipe Fill Loss Level	0.0	1000.0	Varies	0.0	2403	
P9.54	PID Feedback AI Loss PreFreq Timeout	0	6000	s	0	2404	
P9.55	PID Feedback AI Loss Attempts	0	10		1	2405	
P9.56	STO Fault Response				2	2427	0 = No Action 1 = Warning 2 = Fault
P9.57	Fault Reset Start				0	2483	0 = Follow Run Command 1 = Rising Edge After Fault Reset
P9.58	Warning Operation Mode				1	2657	0 = No Action 1 = Warning, No Store 2 = Warning, Store
P9.59	Fan Protection				2	2664	See Par ID 307
P9.60	Under Voltage Trip Level	DCLinkUnderVolt StopLimit	DCLinkOverVolt StopLimit	V	DCLinkUnderVolt ProtectLimit	2666	
P9.61	OP Cont Interlock Attempts	0	10		1	2803	
P9.62 ①	OP Cont Interlock Protection				2	2831	See Par ID 307
P9.63 ①	CP Interlock Run Protection				2	2895	See Par ID 307
P9.64 ①	CP Interlock Stop Protection				1	2896	0 = No Action 1 = Warning, No Store
P9.65	CP Interlock Attempts	0	10		1	2897	

**Table 63. PID Controller 1—P10.**

Code	Parameter	Min.	Max.	Unit	Default	ID	Note
P10.1	PID1 Control Gain	0.00	200.00	%	100.00	1294	
P10.2	PID1 Control ITime	0.00	600.00	s	1.00	1295	
P10.3	PID1 Control DTime	0.00	100.00	s	0.00	1296	

**Note:** ① Parameter value can only be changed after the drive has stopped.  
 ② Parameter value will be set to be default when changing macros.  
 ③ Input function is level sensed.  
 ④ Input function is edge sensed.  
 ⑤ Input function is edge sensed when using StartP/StopP start logic.

## Chapter 6 — Multi-pump and fan control application

**Table 63. PID controller 1—P10, continued.**

Code	Parameter	Min.	Max.	Unit	Default	ID	Note
P10.4 ①	PID1 Process Unit				0	1297	0 = % 1 = 1/min 2 = rpm 3 = ppm 4 = pps 5 = l/s 6 = l/min 7 = l/h 8 = kg/s 9 = kg/min 10 = kg/h 11 = m3/s 12 = m3/min 13 = m3/h 14 = m/s 15 = mbar 16 = bar 17 = Pa 18 = kPa 19 = mVS 20 = kW 21 = Deg. C 22 = GPM 23 = gal/s 24 = gal/min 25 = gal/h 26 = lb/s 27 = lb/min 28 = lb/h 29 = CFM
P10.4 ①, continued	PID1 Process Unit				0	1297	30 = ft3/s 31 = ft3/min 32 = ft3/h 33 = ft/s 34 = in wg 35 = ft wg 36 = PSI 37 = lb/in2 38 = HP 39 = Deg. F 40 = PA 41 = WC 42 = HG 43 = ft 44 = m
P10.5	PID1 Process Unit Min	-99999.99	See Par ID 1300	Varies	0.00	1298	
P10.6	PID1 Process Unit Max	See Par ID 1298	99999.99	Varies	100.00	1300	
P10.7	PID1 Process Unit Decimal	0	4		2	1302	
P10.8 ①	PID1 Error Inversion				0	1303	See Par ID 181
P10.9	PID1 Dead Band	0.00	99999.99	Varies	0.00	1304	
P10.10	PID1 Dead Band Delay	0.00	320.00	s	0.00	1306	
P10.11	PID1 Keypad Set Point 1	See Par ID 1298	See Par ID 1300	Varies	0.00	1307	
P10.12	PID1 Keypad Set Point 2	See Par ID 1298	See Par ID 1300	Varies	0.00	1309	
P10.13	PID1 Ramp Time	0.00	300.00	s	0.00	1311	

- Note:**
- ① Parameter value can only be changed after the drive has stopped.
  - ② Parameter value will be set to be default when changing macros.
  - ③ Input function is level sensed.
  - ④ Input function is edge sensed.
  - ⑤ Input function is edge sensed when using StartP/StopP start logic.

**Table 63. PID controller 1—P10, continued.**

Code	Parameter	Min.	Max.	Unit	Default	ID	Note
P10.14 ①②	PID1 Set Point 1 Source				1	1312	0 = Not Used 1 = PID1 Keypad Set Point 1 2 = PID1 Keypad Set Point 2 3 = AI1 4 = AI2 5 = Slot A: AI1 6 = Slot B: AI1 7 = FB Process Data Input 1 8 = FB Process Data Input 2 9 = FB Process Data Input 3 10 = FB Process Data Input 4 11 = FB Process Data Input 5 12 = FB Process Data Input 6 13 = FB Process Data Input 7 14 = FB Process Data Input 8 16 = Multi Drive Network 17 = FB PID1 Set Point 1 18 = FB PID1 Set Point 2
P10.15	PID1 Set Point 1 Min	-200.00	200.00	%	0.00	1313	
P10.16	PID1 Set Point 1 Max	-200.00	200.00	%	100.00	1314	
P10.17 ③	PID1 Set Point 1 Sleep Enable				0	1315	See Par ID 2462
P10.18 ④	PID1 Set Point 1 Sleep Unit Sel				0	2396	0 = Output Frequency 1 = Motor Speed 2 = Motor Current 3 = PID1 Feedback
P10.19	PID1 Set Point 1 Sleep Level			Varies	0.00	2450	
P10.20	PID1 Set Point 1 Sleep Delay	0	3000	s	0	1317	
P10.21	PID1 Set Point 1 Wake Up Level	-99999.99	99999.99	Varies	0.00	1318	
P10.22	PID1 Set Point 1 Boost	-2.0	2.0		1.0	1320	
P10.23 ①②	PID1 Set Point 2 Source				2	1321	See Par ID 1312
P10.24	PID1 Set Point 2 Min	-200.00	200.00	%	0.00	1322	
P10.25	PID1 Set Point 2 Max	-200.00	200.00	%	100.00	1323	
P10.26 ③	PID1 Set Point 2 Sleep Enable				0	1324	See Par ID 2462
P10.27 ④	PID1 Set Point 2 Sleep Unit Sel				0	2397	See Par ID 2396
P10.28	PID1 Set Point 2 Sleep Level			Varies	0.00	2452	
P10.29	PID1 Set Point 2 Sleep Delay	0	3000	s	0	1326	
P10.30	PID1 Set Point 2 Wake Up Level	-99999.99	99999.99	Varies	0.00	1327	
P10.31	PID1 Set Point 2 Boost	-2.0	2.0		1.0	1329	
P10.32 ⑤	PID1 Feedback Function				0	1330	0 = Source 1 1 = SQRT(Source 1) 2 = SQRT(Source 1 - Source 2) 3 = SQRT(Source 1) + SQRT(Source 2) 4 = Source 1 + Source 2 5 = Source 1 - Source 2 6 = MIN(Source 1,Source 2) 7 = MAX(Source 1,Source 2) 8 = MEAN(Source1,Source2) 9 = Source1*Source2
P10.33	PID1 Feedback Gain	-1000.0	1000.0	%	100.0	1331	

**Note:** ① Parameter value can only be changed after the drive has stopped.  
 ② Parameter value will be set to be default when changing macros.  
 ③ Input function is level sensed.  
 ④ Input function is edge sensed.  
 ⑤ Input function is edge sensed when using StartP/StopP start logic.

## Chapter 6 — Multi-pump and fan control application

**Table 63. PID controller 1—P10, continued.**

Code	Parameter	Min.	Max.	Unit	Default	ID	Note
P10.34 ①②	PID1 Feedback 1 Source				2	1332	0 = Not Used 1 = AI1 2 = AI2 3 = Slot A: AI1 4 = Slot B: AI1 5 = FB Process Data Input 1 6 = FB Process Data Input 2 7 = FB Process Data Input 3 8 = FB Process Data Input 4 9 = FB Process Data Input 5 10 = FB Process Data Input 6 11 = FB Process Data Input 7 12 = FB Process Data Input 8 13 = PT100 Temperature 15 = SlotA PT100 Temp Channel 1 16 = SlotA PT100 Temp Channel 2 17 = SlotA PT100 Temp Channel 3 18 = SlotB PT100 Temp Channel 1 19 = SlotB PT100 Temp Channel 2 20 = SlotB PT100 Temp Channel 3 21 = FB PID1 Feedback 1 22 = FB PID1 Feedback 2
P10.35	PID1 Feedback 1 Min	-200.00	200.00	%	0.00	1333	
P10.36	PID1 Feedback 1 Max	-200.00	200.00	%	100.00	1334	
P10.37 ①②	PID1 Feedback 2 Source				0	1335	See Par ID 1332
P10.38	PID1 Feedback 2 Min	-200.00	200.00	%	0.00	1336	
P10.39	PID1 Feedback 2 Max	-200.00	200.00	%	100.00	1337	
P10.40 ①	PID1 Feedforward Func				0	1338	See Par ID 1330
P10.41	PID1 Feedforward Gain	-1000.0	1000.0	%	100.0	1339	

- Note:**
- ① Parameter value can only be changed after the drive has stopped.
  - ② Parameter value will be set to be default when changing macros.
  - ③ Input function is level sensed.
  - ④ Input function is edge sensed.
  - ⑤ Input function is edge sensed when using StartP/StopP start logic.

**Table 63. PID controller 1—P10, continued.**

Code	Parameter	Min.	Max.	Unit	Default	ID	Note
P10.42 ①②	PID1 Feedforward 1 Source				0	1340	0 = Not Used 1 = AI1 2 = AI2 3 = Slot A: AI1 4 = Slot B: AI1 5 = FB Process Data Input 1 6 = FB Process Data Input 2 7 = FB Process Data Input 3 8 = FB Process Data Input 4 9 = FB Process Data Input 5 10 = FB Process Data Input 6 11 = FB Process Data Input 7 12 = FB Process Data Input 8 13 = PT100 Temperature 15 = SlotA PT100 Temp Channel 1 16 = SlotA PT100 Temp Channel 2 17 = SlotA PT100 Temp Channel 3 18 = SlotB PT100 Temp Channel 1 19 = SlotB PT100 Temp Channel 2 20 = SlotB PT100 Temp Channel 3 21 = FB PID1 Feedforward 1 22 = FB PID1 Feedforward 2
P10.43	PID1 Feedforward 1 Min	-200.00	200.00	%	0.00	1341	
P10.44	PID1 Feedforward 1 Max	-200.00	200.00	%	100.00	1342	
P10.45 ①②	PID1 Feedforward 2 Source				0	1343	See Par ID 1340
P10.46	PID1 Feedforward 2 Min	-200.00	200.00	%	0.00	1344	
P10.47	PID1 Feedforward 2 Max	-200.00	200.00	%	100.00	1345	
P10.48	PID1 Set Point 1 Comp Enable				0	1352	See Par ID 2462
P10.49	PID1 Set Point 1 Comp Max	-200.00	200.00	%	0.00	1353	
P10.50	PID1 Set Point 2 Comp Enable				0	1354	See Par ID 2462
P10.51	PID1 Set Point 2 Comp Max	-200.00	200.00	%	0.00	1355	
P10.52	PID1 Wake Up Action				0	2466	0 = Below Wake Up Level 1 = Above Wake Up Level 2 = Below Wake Up Level (PID ref.) 3 = Above Wake Up Level (PID ref.)
P10.53	FB PID1 Set Point 1	See Par ID 1298	See Par ID 1300	Varies		2542	
P10.54	FB PID1 Set Point 2	See Par ID 1298	See Par ID 1300	Varies		2544	
P10.55	FB PID1 Feedback 1			%		2550	
P10.56	FB PID1 Feedback 2			%		2551	
P10.57	FB PID1 Feedforward 1			%		2554	
P10.58	FB PID1 Feedforward 2			%		2555	
P10.59	PID1 Sleep Boost level	-9999	9999	Varies	0	2660	

**Note:** ① Parameter value can only be changed after the drive has stopped.  
 ② Parameter value will be set to be default when changing macros.  
 ③ Input function is level sensed.  
 ④ Input function is edge sensed.  
 ⑤ Input function is edge sensed when using StartP/StopP start logic.

## Chapter 6 — Multi-pump and fan control application

**Table 63. PID controller 1—P10, continued.**

Code	Parameter	Min.	Max.	Unit	Default	ID	Note
P10.60	PID1 Sleep Boost Max Time	1	300	s	30	2661	
P10.61	PID1 Low Feedback Level	0.0	6000.0	Varies	0.0	2811	
P10.62	PID1 Low Feedback Time	0	3600	s	10	2812	
P10.63 ①	PID1 Low Feedback Protection				0	2813	See Par ID 307
P10.64	PID1 High Feedback Level	0.0	6000.0	Varies	150.0	2814	
P10.65	PID1 High Feedback Time	0	3600	s	5	2815	
P10.66 ①	PID1 High Feedback Protection				0	2816	See Par ID 307
P10.67 ①	PID1 Hysteresis Level	0.0	100.0	Varies	0.0	2817	
P10.68	PID1 Backup Feedback Source				0	2825	0 = Not Used 1 = AI1 2 = AI2 3 = Slot A: AI1 4 = Slot B: AI1

**Table 64. Preset speed—P12.**

Code	Parameter	Min.	Max.	Unit	Default	ID	Note
P12.1	Preset Speed 1	0.00	See Par ID 102	Hz	5.00	105	
P12.2	Preset Speed 2	0.00	See Par ID 102	Hz	10.00	106	
P12.3	Preset Speed 3	0.00	See Par ID 102	Hz	15.00	118	
P12.4	Preset Speed 4	0.00	See Par ID 102	Hz	20.00	119	
P12.5	Preset Speed 5	0.00	See Par ID 102	Hz	25.00	120	
P12.6	Preset Speed 6	0.00	See Par ID 102	Hz	30.00	121	
P12.7	Preset Speed 7	0.00	See Par ID 102	Hz	35.00	122	

**Table 65. Brake—P14.**

Code	Parameter	Min.	Max.	Unit	Default	ID	Note
P14.1 ①	DC-Brake Current	Drive NomCurrCT*15/100	Drive NomCurrCT*15/10	A	DriveNomCurrCT*1/2	254	
P14.2 ①	Start DC-Brake Time	0.00	600.00	s	0.00	263	
P14.3 ①	Stop DC-Brake Frequency	0.10	10.00	Hz	1.50	262	
P14.4 ①	Stop DC-Brake Time	0.00	600.00	s	0.00	255	
P14.5 ①	Brake Chopper Mode				0	251	0 = Disabled 1 = B(Run) T(Rdy) 2 = External 3 = B(Rdy) T(Rdy) 4 = B(Run) T(No)
P14.6 ①	Flux Brake				0	266	0 = Off 1 = On
P14.7 ①	Flux Brake Current	ActiveMotor NomCurr*1/10	See Par ID 107	A	ActiveMotorNomCurr*1/2	265	

**Note:** ① Parameter value can only be changed after the drive has stopped.  
 ② Parameter value will be set to be default when changing macros.  
 ③ Input function is level sensed.  
 ④ Input function is edge sensed.  
 ⑤ Input function is edge sensed when using StartP/StopP start logic.

**Table 66. Fire mode—P15.**

Code	Parameter	Min.	Max.	Unit	Default	ID	Note
P15.1 ①	Fire Mode Function				0	535	0 = Closing Contact 1 = Opening Contact
P15.2 ①②	Fire Mode Ref Select Function				0	536	0 = Fire Mode Min Frequency 1 = Fire Mode Ref 2 = Fieldbus Ref 3 = AI1 4 = AI2 5 = AI1 + AI2 6 = PID1 Control Output
P15.3	Fire Mode Frequency	See Par ID 101	See Par ID 102	Hz	MotorNomFreqMFG	537	
P15.4	Fire Mode % Speed Ref 1	0.0	100.0	%	75.0	565	
P15.5	Fire Mode % Speed Ref 2	0.0	100.0	%	100.0	564	
P15.6 ①	Smoke Purge Frequency	0.0	100.0	%	50.0	554	
P15.7	Fire Mode Test Enable					2443	See Par ID 2462

**Table 67. Second motor parameter—P16.**

Code	Parameter	Min.	Max.	Unit	Default	ID	Note
P16.1 ①	Motor Nom Current 2	DriveNomCurrCT*1/10	DriveNomCurrCT*2	A	DriveNomCurrCT	577	
P16.2 ①	Motor Nom Speed 2	300	20000	rpm	SecdMotorNomSpeedMFG	578	
P16.3 ①	Motor PF 2	0.30	1.00		0.85	579	
P16.4 ①	Motor Nom Volt 2	180	690	V	SecdMotorNomVoltMFG	580	
P16.5 ①	Motor Nom Freq 2	8.00	400.00	Hz	SecdMotorNomFreqMFG	581	
P16.6 ①	Stator Resistor 2	0.001	65.535	ohm	0.033	1419	

## Bypass

**Table 68. Basic setting—P17.1.**

Code	Parameter	Min.	Max.	Unit	Default	ID	Note
P17.1.1 ①	Bypass Enable				0	1418	See Par ID 2462
P17.1.2 ①	Bypass Start Delay	1	32765	s	5	544	
P17.1.3 ①	Auto Bypass				0	542	See Par ID 2462
P17.1.4 ①	Auto Bypass Delay	0	32765	s	10	543	
P17.1.5 ①	OverCurrent Bypass Enable				0	547	See Par ID 2462
P17.1.6 ①	IGBT Fault Bypass Enable				0	546	See Par ID 2462
P17.1.7 ①	4mA Fault Bypass Enable				0	548	See Par ID 2462
P17.1.8 ①	UnderVoltage Bypass Enable				0	545	See Par ID 2462
P17.1.9 ①	OverVoltage Bypass Enable				0	549	See Par ID 2462
P17.1.10 ①	Motor OverTemp Bypass Enable				0	1698	See Par ID 2462
P17.1.11 ①	UnderLoad Bypass Enable				0	1699	See Par ID 2462
P17.1.12 ①	External Bypass Enable				0	1700	See Par ID 2462
P17.1.13 ①	Charge Switch Fault Bypass Enable				0	1701	See Par ID 2462

**Note:** ① Parameter value can only be changed after the drive has stopped.  
 ② Parameter value will be set to be default when changing macros.  
 ③ Input function is level sensed.  
 ④ Input function is edge sensed.  
 ⑤ Input function is edge sensed when using StartP/StopP start logic.

## Chapter 6 — Multi-pump and fan control application

**Table 68 Basic setting—P17.1, continued.**

Code	Parameter	Min.	Max.	Unit	Default	ID	Note
P17.1.14 ①	Saturation Trip Fault Bypass Enable				0	1702	See Par ID 2462
P17.1.15 ①	Under Temp Fault Bypass Enable				0	1703	See Par ID 2462
P17.1.16 ①	EEPROM Fault Bypass Enable				0	1704	See Par ID 2462
P17.1.17 ①	Control board EEPROM Fault Bypass Enable				0	1705	See Par ID 2462
P17.1.18 ①	Watchdog Fault Bypass Enable				0	1706	See Par ID 2462
P17.1.19 ①	Fan Cooling Fault Bypass Enable				0	1707	See Par ID 2462
P17.1.20 ①	Keypad Com Fault Bypass Enable				0	1708	See Par ID 2462
P17.1.21 ①	Option Card Fault Bypass Enable				0	1709	See Par ID 2462
P17.1.22 ①	RTC Clock Fault Bypass Enable				0	1710	See Par ID 2462
P17.1.23 ①	Ctrl Board OverTemp Fault Bypass Enable				0	1711	See Par ID 2462
P17.1.24 ①	Fieldbus Fault Bypass Enable				0	1713	See Par ID 2462
P17.1.25 ①	Op Cont Interlock Fault Bypass Enable				0	2832	See Par ID 2462

**Table 69. Redundant drive—P17.2.**

Code	Parameter	Min.	Max.	Unit	Default	ID	Note
P17.2.1 ①	Redundant Drive Enable				0	2476	See Par ID 2462
P17.2.2 ①	Drive ID	0	5		0	2278	
P17.2.3	Redundant Run Time Enable				0	2477	See Par ID 2462
P17.2.4	Redundant Run Time Reset					2478	See Par ID 2125
P17.2.5	Redundant RunTime Limit	0.00	300000.00	h	0.00	2479	

- Note:**
- ① Parameter value can only be changed after the drive has stopped.
  - ② Parameter value will be set to be default when changing macros.
  - ③ Input function is level sensed.
  - ④ Input function is edge sensed.
  - ⑤ Input function is edge sensed when using StartP/StopP start logic.



## Pump parameters

**Table 70. Basic setting—P18.1.**

Code	Parameter	Min.	Max.	Unit	Default	ID	Note
P18.1.1 ①	Multi-pump Mode				0	2279	0 = Disabled 1 = Single Drive Control 2 = Multi Drive Network
P18.1.2 ①	Drive ID	0	5		0	2278	
P18.1.3	PID Bandwidth	0.00	6000.00	Varies	10.00	2458	
P18.1.4 ①	Staging Frequency	See Par ID 101	400.00		50.00	2315	
P18.1.5 ①	De-Staging Frequency	0.00	See Par ID 102		0.00	2316	
P18.1.6	Add/Remove Delay	0	3600	s	10	344	
P18.1.7	Interlock Enable				0	350	See Par ID 2462
P18.1.8 ①	Damper Start				0	483	0 = Normal 1 = Interlock Start 2 = Interlock Tout 3 = Interlock Delay
P18.1.9 ①	Damper Time Out	1	32500	s	5	484	
P18.1.10 ①	Damper Delay	1	32500	s	5	485	
P18.1.11	Derag Cycles	0	10		3	2468	
P18.1.12	Derag at Start/Stop				0	2469	0 = Off 1 = Start 2 = Stop 3 = Start and Stop 4 = Digital Input
P18.1.13	Deragging Run Time	0	3600	s	0	2470	
P18.1.14	Derag Speed	See Par ID 101	See Par ID 102	Hz	5.00	2471	
P18.1.15	Derag Off Delay	1	600	s	10	2472	
P18.1.16 ①	Multi-pump Mode 2				0	2659	See Par ID 2279

## Multi-pump status

**Table 71. Operation mode—P18.2.1.**

Code	Parameter	Min.	Max.	Unit	Default	ID	Note
P18.2.1.1	MPC Drive1 Operate Mode					2218	0 = Offline 1 = Slave Drive 2 = Master Drive 3 = Redundant Drive
P18.2.1.2	MPC Drive2 Operate Mode					2230	See Par ID 2218
P18.2.1.3	MPC Drive3 Operate Mode					2242	See Par ID 2218
P18.2.1.4	MPC Drive4 Operate Mode					2254	See Par ID 2218
P18.2.1.5	MPC Drive5 Operate Mode					2266	See Par ID 2218

**Note:** ① Parameter value can only be changed after the drive has stopped.  
 ② Parameter value will be set to be default when changing macros.  
 ③ Input function is level sensed.  
 ④ Input function is edge sensed.  
 ⑤ Input function is edge sensed when using StartP/StopP start logic.

**Table 72. Multi-pump status—P18.2.2.**

Code	Parameter	Min.	Max.	Unit	Default	ID	Note
P18.2.2.1	MPC Drive1 Status				5	2219	0 = Stopped 1 = Sleep 2 = Regulating 3 = Wait for CMD 4 = Following 5 = Unknown 6 = Master Local Control 7 = Slave Local Control
P18.2.2.2	MPC Drive2 Status				5	2231	See Par ID 2219
P18.2.2.3	MPC Drive3 Status				5	2243	See Par ID 2219
P18.2.2.4	MPC Drive4 Status				5	2255	See Par ID 2219
P18.2.2.5	MPC Drive5 Status				5	2267	See Par ID 2219

**Table 73. Network status—P18.2.3.**

Code	Parameter	Min.	Max.	Unit	Default	ID	Note
P18.2.3.1	MPC Drive1 NetworkStatus					2220	0 = Disconnected 1 = Fault 2 = Local Control 3 = Pump Lost 4 = Need Alternation 5 = No Error
P18.2.3.2	MPC Drive2 NetworkStatus					2232	See Par ID 2220
P18.2.3.3	MPC Drive3 NetworkStatus					2244	See Par ID 2220
P18.2.3.4	MPC Drive4 NetworkStatus					2256	See Par ID 2220
P18.2.3.5	MPC Drive5 NetworkStatus					2268	See Par ID 2220

## Multi-pump measurement

**Table 74. Latest fault code—P18.3.1.**

Code	Parameter	Min.	Max.	Unit	Default	ID	Note
P18.3.1.1	MPC Drive1 Last Fault Code					2221	
P18.3.1.2	MPC Drive2 Last Fault Code					2233	
P18.3.1.3	MPC Drive3 Last Fault Code					2245	
P18.3.1.4	MPC Drive4 Last Fault Code					2257	
P18.3.1.5	MPC Drive5 Last Fault Code					2269	

**Table 75. Output frequency—P18.3.2.**

Code	Parameter	Min.	Max.	Unit	Default	ID	Note
P18.3.2.1	MPC Drive1 f-Out			Hz		2222	
P18.3.2.2	MPC Drive2 f-Out			Hz		2234	
P18.3.2.3	MPC Drive3 f-Out			Hz		2246	
P18.3.2.4	MPC Drive4 f-Out			Hz		2258	
P18.3.2.5	MPC Drive5 f-Out			Hz		2270	

- Note:**
- ① Parameter value can only be changed after the drive has stopped.
  - ② Parameter value will be set to be default when changing macros.
  - ③ Input function is level sensed.
  - ④ Input function is edge sensed.
  - ⑤ Input function is edge sensed when using StartP/StopP start logic.

**Table 76. Motor voltage—P18.3.3.**

Code	Parameter	Min.	Max.	Unit	Default	ID	Note
P18.3.3.1	MPC Drive1 V-Out			V		2223	
P18.3.3.2	MPC Drive2 V-Out			V		2235	
P18.3.3.3	MPC Drive3 V-Out			V		2247	
P18.3.3.4	MPC Drive4 V-Out			V		2259	
P18.3.3.5	MPC Drive5 V-Out			V		2271	

**Table 77. Motor current—P18.3.4.**

Code	Parameter	Min.	Max.	Unit	Default	ID	Note
P18.3.4.1	MPC Drive1 I-Out			A		2224	
P18.3.4.2	MPC Drive2 I-Out			A		2236	
P18.3.4.3	MPC Drive3 I-Out			A		2248	
P18.3.4.4	MPC Drive4 I-Out			A		2260	
P18.3.4.5	MPC Drive5 I-Out			A		2272	

**Table 78. Motor torque—P18.3.5.**

Code	Parameter	Min.	Max.	Unit	Default	ID	Note
P18.3.5.1	MPC Drive1 M-Out			%		2225	
P18.3.5.2	MPC Drive2 M-Out			%		2237	
P18.3.5.3	MPC Drive3 M-Out			%		2249	
P18.3.5.4	MPC Drive4 M-Out			%		2261	
P18.3.5.5	MPC Drive5 M-Out			%		2273	

**Table 79. Motor power—P18.3.6.**

Code	Parameter	Min.	Max.	Unit	Default	ID	Note
P18.3.6.1	MPC Drive1 P-Out			%		2226	
P18.3.6.2	MPC Drive2 P-Out			%		2238	
P18.3.6.3	MPC Drive3 P-Out			%		2250	
P18.3.6.4	MPC Drive4 P-Out			%		2262	
P18.3.6.5	MPC Drive5 P-Out			%		2274	

**Table 80. Motor speed—P18.3.7.**

Code	Parameter	Min.	Max.	Unit	Default	ID	Note
P18.3.7.1	MPC Drive1 n-Out			rpm		2227	
P18.3.7.2	MPC Drive2 n-Out			rpm		2239	
P18.3.7.3	MPC Drive3 n-Out			rpm		2251	
P18.3.7.4	MPC Drive4 n-Out			rpm		2263	
P18.3.7.5	MPC Drive5 n-Out			rpm		2275	

**Table 81. Run time—P18.3.8.**

Code	Parameter	Min.	Max.	Unit	Default	ID	Note
P18.3.8.1	MPC Drive1 t-Run			h		2228	
P18.3.8.2	MPC Drive2 t-Run			h		2240	
P18.3.8.3	MPC Drive3 t-Run			h		2252	
P18.3.8.4	MPC Drive4 t-Run			h		2264	
P18.3.8.5	MPC Drive5 t-Run			h		2276	

- Note:**
- ① Parameter value can only be changed after the drive has stopped.
  - ② Parameter value will be set to be default when changing macros.
  - ③ Input function is level sensed.
  - ④ Input function is edge sensed.
  - ⑤ Input function is edge sensed when using StartP/StopP start logic.

## Chapter 6 — Multi-pump and fan control application

**Table 82. Multi-Pump Single Drive—P18.4.**

Code	Parameter	Min.	Max.	Unit	Default	ID	Note
P18.4.1 ①	Number of Pumps	1	5		1	342	
P18.4.2	Include Freq Converter				1	346	See Par ID 2462
P18.4.3	Auto-Change Enable				0	345	See Par ID 2462
P18.4.4	Auto-Change Interval	0.0	3000.0	h	48.0	347	
P18.4.5	Auto-Change Freq Limit	See Par ID 101	See Par ID 102	Hz	25.00	349	
P18.4.6	Auto-Change Pump Limit	0	5		1	348	
P18.4.7 ①	Pipe Fill Aux Pump Select				0	2439	0 = Disabled 1 = Aux Motor 1 2 = Aux Motor 2 3 = Aux Motor 3 4 = Aux Motor 4
P18.4.8 ①	Pipe Fill Aux Pump Run Time	0.0	3600.0	min	0.0	2440	
P18.4.9 ①	Pipe Fill Aux Pump Operation				0	2441	0 = Automatic 1 = Stop
P18.4.10 ①	Pipe Fill Aux Pump Delay	0.0	600.0	min	2.0	2442	

**Table 83. Multi-Pump Multi Drive—P18.5.**

Code	Parameter	Min.	Max.	Unit	Default	ID	Note
P18.5.1 ①	Number of Drives	1	5		1	2449	
P18.5.2 ①	Regulation Source				0	2284	0 = Network Only 1 = PID Controller 1
P18.5.3 ①	Recovery Method				0	2285	See Par ID 2441
P18.5.4 ①	Callback Source				0	2286	0 = No Action 1 = Safety Torque Off
P18.5.5	Add/Remove Drive Selection				0	2311	0 = Drive ID 1 = Run Time
P18.5.6	Run Time Enable				0	2280	See Par ID 2462
P18.5.7	Run Time Limit	0.0	300000.0	h	0.0	2281	
P18.5.8	Run Time Reset					2283	0 = No Action 1 = Reset
P18.5.9	Master Drive Mode				0	2473	0 = Follow PID 1 = Fixed Speed 2 = Turn Off
P18.5.10	Master Fixed Speed	See Par ID 101	See Par ID 102	Hz	50.00	2474	
P18.5.11	Master Fixed Speed Delay	0	1000	s	5	2475	

**Table 84. Protections—P18.6.**

Code	Parameter	Min.	Max.	Unit	Default	ID	Note
P18.6.1 ①	Pipe Fill Loss Detection Method				0	2406	0 = Motor Current 1 = Motor Power 2 = Motor Torque
P18.6.2	Pipe Fill Loss Level	0.0	1000.0	Varies	0.0	2407	
P18.6.3	Pipe Fill Loss Time	0	600	s	0	2408	
P18.6.4 ①	Pipe Fill Loss Frequency	0.00	See Par ID 102	Hz	0.00	2409	
P18.6.5 ①	Pipe Fill Loss Response				0	2410	See Par ID 2427
P18.6.6	Pipe Fill Loss Attempts	0	10		1	2411	
P18.6.7	Prime Pump Enable				0	2428	See Par ID 190

**Note:** ① Parameter value can only be changed after the drive has stopped.  
 ② Parameter value will be set to be default when changing macros.  
 ③ Input function is level sensed.  
 ④ Input function is edge sensed.  
 ⑤ Input function is edge sensed when using StartP/StopP start logic.

**Table 84. Protections—P18.6, continued**

Code	Parameter	Min.	Max.	Unit	Default	ID	Note
P18.6.8	Prime Pump Level	0.00	6000.00	Varies	0.00	2429	
P18.6.9	Prime Pump Frequency	See Par ID 101	See Par ID 102	Hz	0.00	2431	
P18.6.10	Prime Pump Delay Time	0.0	3600.0	min	0.0	2432	
P18.6.11	Prime Pump Loss of Prime Level	0.0	1000.0	Varies	0.0	2433	
P18.6.12	Prime Pump Level 2	0.00	6000.00	Varies	0.00	2434	
P18.6.13	Prime Pump Frequency 2	See Par ID 101	See Par ID 102	Hz	0.00	2436	
P18.6.14	Prime Pump Delay Time 2	0.0	3600.0	min	0.0	2437	
P18.6.15	Prime Pump Loss of Prime Level 2	0.0	1000.0	Varies	0.0	2438	
P18.6.16 ①	Broken Pipe Fault Response				0	1853	See Par ID 307
P18.6.17	Broken Pipe Level	0.0	6000.0	Varies	15.0	1854	
P18.6.18	Broken Pipe Delay	1.0	120.0	s	15.0	1855	
P18.6.19	Broken Pipe Frequency	1.00	See Par ID 102	Hz	25.00	1856	
P18.6.20	Jockey Pump Enable				0	2804	0 = Not Used 1 = PID Sleep 2 = PID Sleep(Level)
P18.6.21	Jockey Start Level	-99999.99	See Par ID 2807	Varies	0.00	2805	
P18.6.22	Jockey Stop Level	See Par ID 2805	99999.99	Varies	0.00	2807	
P18.6.23	Lube Pump Enable				0	2809	See Par ID 2462
P18.6.24	Lube Pump Time	0.0	300.0	s	0.0	2810	

**Note:** ① Parameter value can only be changed after the drive has stopped.  
 ② Parameter value will be set to be default when changing macros.  
 ③ Input function is level sensed.  
 ④ Input function is edge sensed.  
 ⑤ Input function is edge sensed when using StartP/StopP start logic.

## Chapter 6 — Multi-pump and fan control application

**Table 85. Real time clock—P19.**

Code	Parameter	Min.	Max.	Unit	Default	ID	Note
P19.1	Interval 1 On Time				0,0,0	491	
P19.2	Interval 1 Off Time				0,0,0	493	
P19.3	Interval 1 From Day				0	517	0 = Sunday 1 = Monday 2 = Tuesday 3 = Wednesday 4 = Thursday 5 = Friday 6 = Saturday
P19.4	Interval 1 To Day				0	518	See Par ID 517
P19.5	Interval 1 Channel				0	519	0 = Not Used 1 = Time Channel 1 2 = Time Channel 2 3 = Time Channel 3
P19.6	Interval 2 On Time				0,0,0	495	
P19.7	Interval 2 Off Time				0,0,0	497	
P19.8	Interval 2 From Day				0	520	See Par ID 517
P19.9	Interval 2 To Day				0	521	See Par ID 517
P19.10	Interval 2 Channel				0	522	See Par ID 519
P19.11	Interval 3 On Time				0,0,0	499	
P19.12	Interval 3 Off Time				0,0,0	501	
P19.13	Interval 3 From Day				0	523	See Par ID 517
P19.14	Interval 3 To Day				0	524	See Par ID 517
P19.15	Interval 3 Channel				0	525	See Par ID 519
P19.16	Interval 4 On Time				0,0,0	503	
P19.17	Interval 4 Off Time				0,0,0	505	
P19.18	Interval 4 From Day				0	526	See Par ID 517
P19.19	Interval 4 To Day				0	527	See Par ID 517
P19.20	Interval 4 Channel				0	528	See Par ID 519
P19.21	Interval 5 On Time				0,0,0	507	
P19.22	Interval 5 Off Time				0,0,0	509	
P19.23	Interval 5 From Day				0	529	See Par ID 517
P19.24	Interval 5 To Day				0	530	See Par ID 517
P19.25	Interval 5 Channel				0	531	See Par ID 519
P19.26	Timer 1 Duration	0	72000	s	0	511	
P19.27	Timer 1 Channel				0	532	See Par ID 519
P19.28	Timer 2 Duration	0	72000	s	0	513	
P19.29	Timer 2 Channel				0	533	See Par ID 519
P19.30	Timer 3 Duration	0	72000	s	0	515	
P19.31	Timer 3 Channel				0	534	See Par ID 519
P19.32	Interval 1 Setting				0	2487	0 = Weekly 1 = Daily
P19.33	Interval 2 Setting				0	2488	See Par ID 2487
P19.34	Interval 3 Setting				0	2489	See Par ID 2487
P19.35	Interval 4 Setting				0	2490	See Par ID 2487
P19.36	Interval 5 Setting				0	2491	See Par ID 2487

- Note:**
- ① Parameter value can only be changed after the drive has stopped.
  - ② Parameter value will be set to be default when changing macros.
  - ③ Input function is level sensed.
  - ④ Input function is edge sensed.
  - ⑤ Input function is edge sensed when using StartP/StopP start logic.

## Communication

**Table 86. FB process data input Sel—P20.1.**

Code	Parameter	Min.	Max.	Unit	Default	ID	Note
P20.1.1	FB Process Data Input 1 Sel	0	3000		2541	2533	
P20.1.2	FB Process Data Input 2 Sel	0	See Par ID 2533		2542	2534	
P20.1.3	FB Process Data Input 3 Sel	0	See Par ID 2533		2550	2535	
P20.1.4	FB Process Data Input 4 Sel	0	See Par ID 2533		0	2536	
P20.1.5	FB Process Data Input 5 Sel	0	See Par ID 2533		0	2537	
P20.1.6	FB Process Data Input 6 Sel	0	See Par ID 2533		0	2538	
P20.1.7	FB Process Data Input 7 Sel	0	See Par ID 2533		0	2539	
P20.1.8	FB Process Data Input 8 Sel	0	See Par ID 2533		0	2540	

**Table 87. FB process data output Sel—P20.2.**

Code	Parameter	Min.	Max.	Unit	Default	ID	Note
P20.2.1	FB Process Data Output 1 Sel				1	1556	
P20.2.2	FB Process Data Output 2 Sel				2	1557	
P20.2.3	FB Process Data Output 3 Sel				3	1558	
P20.2.4	FB Process Data Output 4 Sel				4	1559	
P20.2.5	FB Process Data Output 5 Sel				5	1560	
P20.2.6	FB Process Data Output 6 Sel				6	1561	
P20.2.7	FB Process Data Output 7 Sel				7	1562	
P20.2.8	FB Process Data Output 8 Sel				28	1563	

- Note:**
- ① Parameter value can only be changed after the drive has stopped.
  - ② Parameter value will be set to be default when changing macros.
  - ③ Input function is level sensed.
  - ④ Input function is edge sensed.
  - ⑤ Input function is edge sensed when using StartP/StopP start logic.

**Table 87. FB Process data output Sel—P20.2, continued.**

Code	Parameter	Min.	Max.	Unit	Default	ID	Note
P20.2.9 ②	Standard Status Word Bit0 Function Select				1	2415	0 = Not Used 1 = Ready 2 = Run 3 = Fault 4 = Fault Invert 5 = Warning 6 = Reversed 7 = At Speed 8 = Zero Frequency 9 = Freq Limit 1 Superv 10 = Freq Limit 2 Superv 11 = PID1 Superv 13 = OverHeat Fault 14 = OverCurrent Regular 15 = OverVoltage Regular 16 = UnderVoltage Regular 17 = 4mA Ref Fault/Warning 20 = Torq Limit Superv 21 = Ref Limit Superv 22 = Control from I/O 23 = Un-Requested Rotation Direction 24 = Thermistor Fault Output 25 = Fire Mode 26 = In Bypass Mode 27 = Ext Fault/Warning 28 = Remote Control 29 = Jog Speed Select 30 = Motor Therm Protection 31 = FB Digital Input 1 32 = FB Digital Input 2 33 = FB Digital Input 3 34 = FB Digital Input 4 35 = Damper Control 36 = TC1 Status 37 = TC2 Status 38 = TC3 Status 39 = In E-Stop 40 = Power Limit Superv 41 = Temp Limit Superv 42 = Analog Input Superv 43 = Motor 1 Control 44 = Motor 2 Control 45 = Motor 3 Control 46 = Motor 4 Control 47 = Motor 5 Control 49 = PID1 Sleep 51 = Motor Current 1 Supv 52 = Motor Current 2 Supv 53 = Second AI Limit Supv 54 = DC Charge Switch Close 55 = Preheat Active 56 = Cold Weather Active 57 = Prime Pump Active 58 = 2th Stage Ramp Frequency Active 59 = STO Fault Output 60 = Run Bypass/Drive 61 = Bypass Overload 62 = Bypass Run 63 = Auto Local On COM Fault 64 = FieldBus RTU Fault 65 = FieldBus TCP Fault

- Note:**
- ① Parameter value can only be changed after the drive has stopped.
  - ② Parameter value will be set to be default when changing macros.
  - ③ Input function is level sensed.
  - ④ Input function is edge sensed.
  - ⑤ Input function is edge sensed when using StartP/StopP start logic.



**Table 87. FB Process data output Sel—P20.2, continued.**

Code	Parameter	Min.	Max.	Unit	Default	ID	Note
P20.2.9 ②, continued	Standard Status Word Bit0 Function Select				1	2415	66 = FieldBus MSTP Fault 67 = FieldBus EIP Fault 68 = FieldBus SlotA Fault 69 = Fieldbus SlotB Fault 70 = FieldBus SWD Fault 71 = Jockey Pump Active 72 = Lube Pump Active 73 = PID1 Low Feedback 74 = PID1 High Feedback 77 = Master in MPFC 78 = CP Interlock Fault
P20.2.10 ②	Standard Status Word Bit1 Function Select				2	2416	See Par ID 2415
P20.2.11 ②	Standard Status Word Bit2 Function Select				3	2417	See Par ID 2415
P20.2.12 ②	Standard Status Word Bit3 Function Select				4	2418	See Par ID 2415
P20.2.13 ②	Standard Status Word Bit4 Function Select				5	2419	See Par ID 2415
P20.2.14 ②	Standard Status Word Bit5 Function Select				6	2420	See Par ID 2415
P20.2.15 ②	Standard Status Word Bit6 Function Select				7	2421	See Par ID 2415
P20.2.16 ②	Standard Status Word Bit7 Function Select				8	2422	See Par ID 2415

## RS-485 Bus

**Table 88. Basic setting—P20.3.1.**

Code	Parameter	Min.	Max.	Unit	Default	ID	Note
P20.3.1.1 ①	RS485 Comm Set				0	586	0 = Modbus RTU 1 = BACnet MS/TP 2 = SWD

**Table 89. Modbus RTU—P20.3.2.**

Code	Parameter	Min.	Max.	Unit	Default	ID	Note
P20.3.2.1 ①	Slave Address	1	247		1	587	
P20.3.2.2 ①	Baud Rate				1	584	0 = 9600 1 = 19200 2 = 38400 3 = 57600 4 = 115200
P20.3.2.3 ①	Parity Type And Stop Bit				2	585	0 = None and 2 stop bits 1 = Odd and 1 stop bit 2 = Even and 1 stop bit 3 = None and 1 stop bit
P20.3.2.4	Modbus RTU Protocol Status					588	0 = Initial 1 = Stopped 2 = Operational 3 = Faulted
P20.3.2.5	Comm Timeout Modbus RTU	0	60000	ms	10000	593	
P20.3.2.6	Modbus RTU Fault Response				0	2516	0 = in Fieldbus Control 1 = in all Control

**Note:** ① Parameter value can only be changed after the drive has stopped.  
 ② Parameter value will be set to be default when changing macros.  
 ③ Input function is level sensed.  
 ④ Input function is edge sensed.  
 ⑤ Input function is edge sensed when using StartP/StopP start logic.

## Chapter 6 — Multi-pump and fan control application

**Table 90. BACnet MS/TP—P20.3.3.**

Code	Parameter	Min.	Max.	Unit	Default	ID	Note
P20.3.3.1	MSTP Baud Rate				2	594	0 = 9600 1 = 19200 2 = 38400 3 = 76800 4 = 115200
P20.3.3.2	MSTP Device Address	0	127		1	595	
P20.3.3.3	MSTP Instance Number	0	4194302		0	596	
P20.3.3.4	MSTP Comm Timeout	0	60000	ms	10000	598	
P20.3.3.5	MSTP Protocol Status				0	599	0 = Stopped 1 = Operational 2 = Faulted
P20.3.3.6	MSTP Fault Code				0	600	0 = None 1 = Sole Master 2 = Duplicate MAC ID 3 = Baud rate fault
P20.3.3.7	MSTP Fault Response				0	2526	See Par ID 2516
P20.3.3.8 ①	MSTP Max Master	1	127		127	1537	

**Table 91. Terminal: SWD—P20.3.4.**

Code	Parameter	Min.	Max.	Unit	Default	ID	Note
P20.3.4.1	Parameter Access				1	2360	0 = Local Control 1 = Fieldbus
P20.3.4.2 ①	Process Data Access				4	2631	0 = Local Control 1 = Fieldbus 2 = Mixed Interface 4 = NET, Local on Fault 5 = Dual Mode
P20.3.4.3	Fault Situation Counter					2632	
P20.3.4.4	Board Status					2609	
P20.3.4.5	Firmware Version					2610	
P20.3.4.6	Protocol Status					2612	0 = Not Configured 1 = Operational 2 = Diagnostics
P20.3.4.7	Operation Mode					2613	0 = PD2x16Bit Profil 1 = 8Bit Profil 2 = 1-0-A Switch
P20.3.4.8	PDP-Telegram Selection				1	2614	1 = Standard Telegram 1
P20.3.4.9	Fault Counter PDP				0	2615	
P20.3.4.10	Fault Situations Max				8,8	2616	
P20.3.4.11	PDP-Profil Number				809	2618	
P20.3.4.12	PDP-Control Word					2619	
P20.3.4.13	PDP-Status Word				64	2620	
P20.3.4.14	PDP-MaxBlockLength				30	2621	
P20.3.4.15	PDP-NoOfMultiparameter				1	2622	
P20.3.4.16	PDP-MaxLatency				2	2623	
P20.3.4.17	PDP-DO Manufacturer					2624	
P20.3.4.18	PDP-DO Device Type					1451	
P20.3.4.19	PDP-DO FW-Interface					2625	

- Note:**
- ① Parameter value can only be changed after the drive has stopped.
  - ② Parameter value will be set to be default when changing macros.
  - ③ Input function is level sensed.
  - ④ Input function is edge sensed.
  - ⑤ Input function is edge sensed when using StartP/StopP start logic.

**Table 91. Terminal: SWD—P20.3.4, continued.**

Code	Parameter	Min.	Max.	Unit	Default	ID	Note
P20.3.4.20	PDP-DO FW-Year					2626	
P20.3.4.21	PDP-DO FW-DayMonth					2627	
P20.3.4.22	PDP-DO NoOfDOs				1	2628	
P20.3.4.23	PDP-DO Subclass				1	2629	

**Table 92. EtherNet/IP—P20.4.**

Code	Parameter	Min.	Max.	Unit	Default	ID	Note
P20.4.1 ①	IP Address Mode				0	1500	0 = Static IP 1 = DHCP with AutoIP
P20.4.2	Active IP Address					1507	
P20.4.3	Active Subnet Mask					1509	
P20.4.4	Active Default Gateway					1511	
P20.4.5	MAC Address					1513	
P20.4.6 ①	Static IP Address				192.168.1.254	1501	
P20.4.7 ①	Static Subnet Mask				255.255.255.0	1503	
P20.4.8 ①	Static Default Gateway				192.168.1.1	1505	
P20.4.9	Ethernet IP Protocol Status					608	0 = Off 1 = Operational 2 = Faulted
P20.4.10	EIP Fault Response				0	2518	See Par ID 2516

**Table 93. Modbus TCP—P20.5.**

Code	Parameter	Min.	Max.	Unit	Default	ID	Note
P20.5.1	Connection Limit				5	609	
P20.5.2	Modbus TCP Unit ID				1	610	
P20.5.3	Comm Timeout Modbus TCP	0	60000	ms	10000	611	
P20.5.4	Modbus TCP Protocol Status					612	See Par ID 599
P20.5.5	Modbus TCP Fault Response				0	2517	See Par ID 2516
P20.5.6	Modbus TCP Trusted IP Enable				0	74	See Par ID 2462
P20.5.7	Trusted IP White List				0xC0.0xA8.0x01.0xFF. 0x00.0x00.0x00.0x00. 0x00.0x00.0x00.0x00	68	

**Table 94. WebUI—P20.6.**

Code	Parameter	Min.	Max.	Unit	Default	ID	Note
P20.6.1	WebUI Protocol Status					2915	See Par ID 608
P20.6.2	WebUI Fault Response				0	2916	See Par ID 2516
P20.6.3	WebUI Communication Timeout	30000	60000	ms	60000	2919	
P20.6.4 ①	WebUI Enable				1	2921	See Par ID 2462

**Note:** ① Parameter value can only be changed after the drive has stopped.  
 ② Parameter value will be set to be default when changing macros.  
 ③ Input function is level sensed.  
 ④ Input function is edge sensed.  
 ⑤ Input function is edge sensed when using StartP/StopP start logic.

## System

**Table 95. Basic setting—P21.1.**

Code	Parameter	Min.	Max.	Unit	Default	ID	Note
P21.1.1	Language				0	340	0 = English 1 = 中文 2 = Deutsch
P21.1.2 ①	Application					142	0 = Standard 1 = Multi-Pump 2 = Multi-PID 3 = Multi-Purpose
P21.1.3 ①	Parameter Sets					619	0 = No 1 = Reload Defaults 2 = Reload Set 1 3 = Reload Set 2 4 = Store Set 1 5 = Store Set 2 6 = Reset 7 = Reload Defaults VM
P21.1.4	Up To Keypad					620	See Par ID 2118
P21.1.5 ①	Down From Keypad					621	0 = No 1 = All Parameters 2 = All, No Motor 3 = App Parameters
P21.1.6	Parameter Comparison					623	0 = No 1 = Compare with Keypad 2 = Compare with Default 3 = Compare with Set 1 4 = Compare with Set 2
P21.1.7	Password	0	9999		0	624	
P21.1.8	Parameter Lock				0	625	0 = Change Enable 1 = Change Disable
P21.1.9	Multi-monitor Set				0	627	See Par ID 625
P21.1.10	Default Page				2	628	
P21.1.11	Timeout Time	0	65535	s	30	629	
P21.1.12	Contrast Adjust	5	18		12	630	
P21.1.13	Backlight Time	1	65535	min	10	631	
P21.1.14	Fan Control				1	632	
P21.1.15	Keypad ACK Timeout	200	5000	ms	200	633	
P21.1.16	Keypad Retry Number	1	10		5	634	
P21.1.17	Startup Wizard				0	626	
P21.1.18	Jog Softkey Hidden				0	2412	See Par ID 2462
P21.1.19	Reverse Softkey Hidden				0	2413	See Par ID 2462
P21.1.20	Output Display Unit				45	2424	
P21.1.21	Output Display Unit Min	-60000.00	See Par ID 2425	Varies	0.00	2460	
P21.1.22	Output Display Unit Max	See Par ID 2460	60000.00	Varies	MotorNomFreqMFG	2425	
P21.1.23	Keypad Lock Password	0	9999		0	75	

**Note:** ① Parameter value can only be changed after the drive has stopped.  
 ② Parameter value will be set to be default when changing macros.  
 ③ Input function is level sensed.  
 ④ Input function is edge sensed.  
 ⑤ Input function is edge sensed when using StartP/StopP start logic.

**Table 96. Version info.—P21.2.**

Code	Parameter	Min.	Max.	Unit	Default	ID	Note
P21.2.1	Keypad Software Version					640	
P21.2.2	Motor Control Software Version					642	
P21.2.3	Application Software Version					644	
P21.2.4	Software Bundle Version					1714	

**Table 97. Application info.—P21.3.**

Code	Parameter	Min.	Max.	Unit	Default	ID	Note
P21.3.1	Brake Chopper Status					646	See Par ID 2118
P21.3.2	Brake Resistor Status					647	See Par ID 2118
P21.3.3	Serial Number					648	
P21.3.4	Power Unit Serial Number					1270	
P21.3.5	Control Unit Serial Number					1276	

**Table 98. User info.—P21.4.**

Code	Parameter	Min.	Max.	Unit	Default	ID	Note
P21.4.1	Real Time Clock				0.0.0.1:1:13	566	
P21.4.2	Daylight Saving				0	582	
P21.4.3	Total MWh Count			Mwh		601	0 = Off 1 = EU 2 = US
P21.4.4	Total Power Day Count					603	
P21.4.5	Total Power Hr Count					606	
P21.4.6	Trip MWh Count			Mwh		604	
P21.4.7	Clear Trip MWh Count					635	See Par ID 2125
P21.4.8	Trip Power Day Count					636	
P21.4.9	Trip Power Hr Count					637	
P21.4.10	Clear Trip Power Count					639	See Par ID 2125

**Table 99. Operate mode—O.**

Code	Parameter	Min.	Max.	Unit	Default	ID	Note
O1	Output Frequency			Hz		1	
O2	Freq Reference			Hz		24	
O3	Motor Speed			rpm		2	
O4	Motor Current			A		3	
O5	Motor Torque			%		4	
O6	Motor Power			%		5	
O7	Motor Voltage			V		6	
O8	DC-link Voltage			V		7	
O9	Unit Temperature			Deg. C		8	
O10	Motor Temperature			%		9	
R12	Keypad Reference	See Par ID 101	See Par ID 102	Hz	0.00	141	
R13	PID1 Keypad Set Point 1	See Par ID 1298	See Par ID 1300	Varies	0.00	1307	
R14	PID1 Keypad Set Point 2	See Par ID 1298	See Par ID 1300	Varies	0.00	1309	

**Note:** ① Parameter value can only be changed after the drive has stopped.  
 ② Parameter value will be set to be default when changing macros.  
 ③ Input function is level sensed.  
 ④ Input function is edge sensed.  
 ⑤ Input function is edge sensed when using StartP/StopP start logic.

# Chapter 7—Multi-PID application

## Introduction

The Multi-PID application is designed to be used with up to 2 PID control applications determined by the use of a digital input; it is typically used with pumps and fans to maintain a desired set-point. With PID, the frequency converter is given a set reference from a keypad, analog inputs, or fieldbus data-in. It also uses an analog probe that measures flow, temperature, and pressure in the system referred to as feedback. The frequency converter takes the feedback signal and compares it to the set point. From there based off the Gain, Integral time, and Derivative time, it corrects the speed of the motor to meet the set point value and maintain it; no additional components. Drive controlwise it provides the ability to have 2 control and reference locations with 8 digital inputs, 2 analog inputs, 3 relay outputs, 1 digital output, and 2 analog outputs that are programmable. Motor control is customizable to frequency or speed control, and the V/Hz curve can be programmable. Drive/motor protection selections can be programmable to defined actions. Below is a list of additional features available in addition to the Standard and Multi-pump and Fan application features that are available in the Multi-PID application.

Multi-PID Application includes all the functions in Multi-pump and Fan application, and additional functions:

- The Second PID control

## I/O controls

- “Terminal to Function” (TTF) programming

The design behind the programming of the digital inputs in the DG1 drive is to use “Terminal to Function” programming, which is composed of multiple functions that get assigned a digital input to that function. The parameters in the drive are set up with specific functions and by defining the digital input and slot in some cases, depending on which options are available. For use of the drives control board inputs, they will be referred to as DigIN:1 through DigIN:8. When additional option cards are used, they will be defined as DigIN:X:IOY:Z. The X indicates the slot that the card is being installed in, which will be either A or B. The IOY determines the type of card it is, which would be IO1 or IO5. The Z indicates which input is being used on that available option card.

- “Function to Terminal” (FTT) programming

The design behind the programming of the relay outputs and digital output in the DG1 drive is to use “Function to Terminal” programming. It is composed of a terminal, be it a relay output or a digital output, that is assigned a parameter. Within that parameter, it has different functions that can be set.

The parameters of the Multi-PID Application are explained on **page 108** of this manual, “Description of Parameters.” The explanations are arranged according to the parameter number.

## Force Open/Force Close Selection

The Force Open selection would make the selected function always off. Essentially this is a virtual switch that is always open.

The Force Close selection would make the selected function always on. Essentially this is a virtual switch that is always closed.

These options are assigned to a function if we want to force a state without using a hardware input.

## Example:

If we set Run Enable to Force Closed, the drive is always enabled. If we set the same function to Force Open, the drive would never be enabled. If a digital input is to be used to activate this Run Enable, the function should be assigned to a hardware input (see below for DIGIN selections).

## DIGIN Selection

This allows assignment of a hardware digital input to a function, this is set in a format of DigIN:X where X is one of the 8 Digital inputs on the Main control board.

## Example:

If we set Run Enable to DigIN:6, the drive will be enabled when digital input 6 (terminal 8) is closed, and would not be enabled when digital input 6 (terminal 8) is open.

### Option Board DigIN Selection

This allows assignment of a hardware digital input on an option card to a function, this is set in a format of DigIN: Y:IO1:X where Y is the slot the option card is inserted on the main control board and X is the Input on the board and IO1 is the type of option board used.

#### Example:

If we set Run Enable to DigIN:A:IO5:6, the drive will be enabled when digital input 6 is closed on the IO5 option card which is inserted in Slot A, and would not be enabled when digital input 6 on the option card is open.

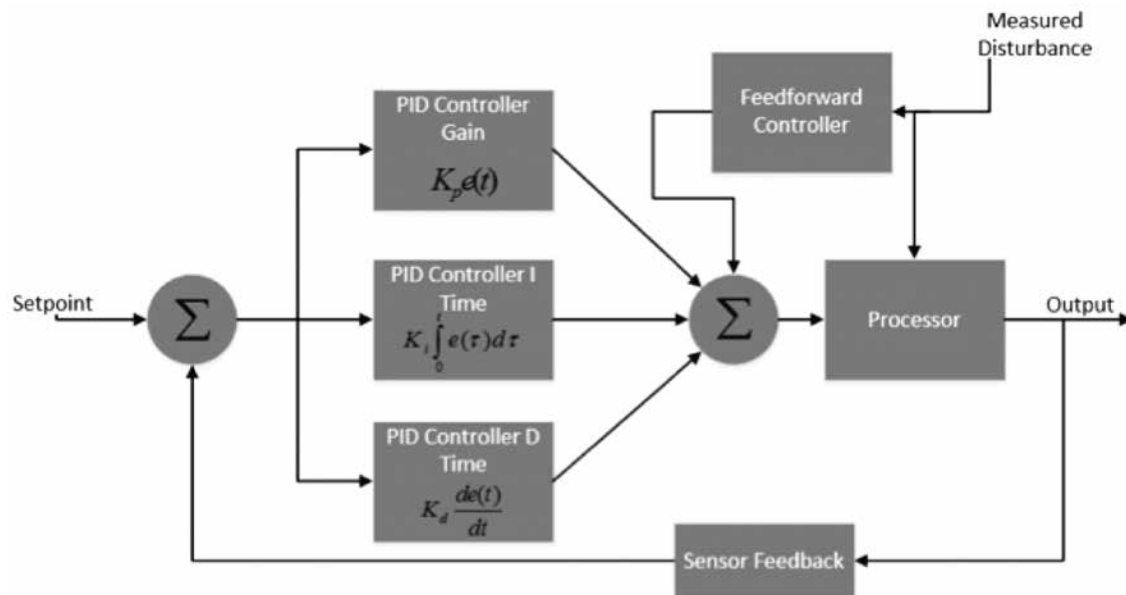
### Timer Channel Selection

A Time Channel is a virtual path to link the digital output of a timer function to a digital input function. To utilize this feature, a timer or interval would need to be assigned to a Time Channel 1 through 3, and the input function to be controlled would need to be assigned to the same time channel.

#### Example:

If we set Run Enable to DigIN:TimeChannel1, the drive will be enabled when the timer assigned to Time Channel 1 is active or High, and would not be enabled when the Time Channel is inactive or Low.

Figure 38. PID controller flowchart.



**Control I/O configuration**

- Run 240 Vac and 24 Vdc control wiring in separate conduit
- Communication wire to be shielded

**Table 100. Multi-PID application default I/O configuration.**



External Wiring	Pin	Signal Name	Signal	Default Setting	Description
	1	+10 V	Ref. Output Voltage	—	10 Vdc Supply Source
	2	AI1+ ①	Analog Input 1	0–10 V	Voltage Speed Reference (Programmable to 4 mA to 20 mA)
	3	AI1–	Analog Input 1 Ground	—	Analog Input 1 Common (Ground)
	4	AI2+ ①	Analog Input 2	4 mA to 20 mA	Current Speed Reference (Programmable to 0–10 V)
	5	AI2–	Analog Input 2 Ground	—	Analog Input 2 Common (Ground)
	6	GND	I/O Signal Ground	—	I/O Ground for Reference and Control
	7	DIN5	Digital Input 5	Preset Speed B0	Sets frequency output to Preset Speed 1
	8	DIN6	Digital Input 6	Preset Speed B1	Sets frequency output to Preset Speed 2
	9	DIN7	Digital Input 7	Not Used (TI–)	Input forces VFD output to shut off
	10	DIN8	Digital Input 8	Force Remote (TI+)	Input takes VFD from Local to Remote
	11	CMB	DI5 to DI8 Common	Grounded	Allows source input
	12	GND	I/O Signal Ground	—	I/O Ground for Reference and Control
	13	24 V	+24 Vdc Output	—	Control voltage output (100 mA max.)
	14	DO1	Digital Output 1	Ready	Shows the drive is ready to run
	15	24 Vo	+24 Vdc Output	—	Control voltage output (100 mA max.)
	16	GND	I/O Signal Ground	—	I/O Ground for Reference and Control
	17	AO1+	Analog Output 1	Output Frequency	Shows Output frequency to motor 0–60 Hz (4 mA to 20 mA)
	18	AO2+	Analog Output 2	Motor Current	Shows Motor current of motor 0–FLA (4 mA to 20 mA)
	19	24 Vi	+24 Vdc Input	—	External control voltage input
	20	DIN1	Digital Input 1	Run Forward	Input starts drive in forward direction (start enable)
	21	DIN2	Digital Input 2	Run Reverse	Input starts drive in reverse direction (start enable)
	22	DIN3	Digital Input 3	External Fault	Input causes drive to fault
	23	DIN4	Digital Input 4	Fault Reset	Input resets active faults
	24	CMA	DI1 to DI4 Common	Grounded	Allows source input
	25	A/+	RS-485 Signal A	—	Fieldbus Communication (Modbus, BACnet)
	26	B/-	RS-485 Signal B	—	Fieldbus Communication (Modbus, BACnet)
	27	R3NO	Relay 3 Normally Open	At Speed	Relay output 3 shows VFD is at Ref. Frequency
	28	R1NC	Relay 1 Normally Closed	Run	Relay output 1 shows VFD is in a run state
	29	R1CM	Relay 1 Common		
	30	R1NO	Relay 1 Normally Open		
	31	R3CM	Relay 3 Common	At Speed	Relay output 3 shows VFD is at Ref. Frequency
	32	R2NC	Relay 2 Normally Closed	Fault	Relay output 2 shows VFD is in a fault state
	33	R2CM	Relay 2 Common		
	34	R2NO	Relay 2 Normally Open		

**Notes:** The above wiring demonstrates a SINK configuration. It is important that CMA and CMB are wired to ground (as shown by dashed line). If a SOURCE configuration is desired, wire 24 V to CMA and CMB and close the inputs to ground. When using the +10 V for AI1, it is important to wire AI1— to ground (as shown by dashed line). If using +10 V for AI1 or AI2, terminals 3, 5, and 6 need to be jumpered together.

① AI1+ and AI2+ Support 10K potentiometer.



**Table 101. Drive communication ports.**

<b>Port</b>	<b>Communication</b>
<b>RJ45 Keypad Port</b>	
Upload/Download Parameters	USB to RJ45
Remote Mount Keypad	Ethernet
Upgrade Drive Firmware	USB to RJ45
<b>RJ45 Ethernet Port</b>	
Upload/Download Parameters	Ethernet
Ethernet IP Communications	Ethernet
Modbus TCP Communications	Ethernet
<b>RS-485 Serial Port</b> ①	
Upload/Download Parameters	Two-Wire Twisted Pair
Upgrade Drive Firmware	Two-Wire Twisted Pair
Modbus RTU Communications	Two-Wire Twisted Pair
BACnet MS/TP Communications	Two-Wire Twisted Pair

① Shielded wire recommended.

### Multi-PID application—parameters list

On the next pages you will find the lists of parameters within the respective parameter groups. The parameter descriptions are given on **Page 194**, “Description of Parameters.” The descriptions are arranged according to the parameter number.

Column explanations:

Code = Location indication on the keypad; shows the operator the present parameter number

Parameter = Name of parameter

Min = Minimum value of parameter

Max = Maximum value of parameter

Unit = Unit of parameter value; given if available

Default = Value preset by factory

ID = ID number of the parameter

**Table 100. Monitor—M.**

Code	Parameter	Min.	Max.	Unit	Default	ID	Note
M1	Output Frequency			Hz		1	
M2	Freq Reference			Hz		24	
M3	Motor Speed			rpm		2	
M4	Motor Current			A		3	
M5	Motor Torque			%		4	
M6	Motor Power			%		5	
M7	Motor Voltage			V		6	
M8	DC-link Voltage			V		7	
M9	Unit Temperature			Deg, C		8	
M10	Motor Temperature			%		9	
M12	Analog Input 1			Varies		10	
M13	Analog Input 2			Varies		11	
M14	Analog Output 1			Varies		25	
M15	Analog Output 2			Varies		575	
M16	DI1, DI2, DI3					12	
M17	DI4, DI5, DI6					13	
M18	DI7, DI8					576	
M19	DO1,Virtual RO1,Virtual RO2					14	
M20	RO1, RO2, RO3					557	
M21	TC1, TC2, TC3					558	
M22	Interval 1					559	0 = Inactive 1 = Active
M23	Interval 2					560	See Par ID 559
M24	Interval 3					561	See Par ID 559
M25	Interval 4					562	See Par ID 559
M26	Interval 5					563	See Par ID 559
M27	Timer 1			s	0	569	
M28	Timer 2			s	0	571	
M29	Timer 3			s	0	573	
M30	PID1 Set Point			Varies		16	
M31	PID1 Feedback			Varies		18	
M32	PID1 Error Value			Varies		20	
M33	PID1 Output			%		22	

- Notes:**
- ① Parameter value can only be changed after the drive has stopped.
  - ② Parameter value will be set to be default when changing macros.
  - ③ Input function is level sensed.
  - ④ Input function is edge sensed.
  - ⑤ Input function is edge sensed when using StartP/StopP start logic.

**Table 100. Monitor—M, continued**

Code	Parameter	Min.	Max.	Unit	Default	ID	Note
M34	PID1 Status					23	0 = Stopped 1 = Running 2 = Sleep Mode
M35	PID2 Set Point			Varies		32	
M36	PID2 Feedback			Varies		34	
M37	PID2 Error Value			Varies		36	
M38	PID2 Output			%		38	
M39	PID2 Status					39	See Par ID 23
M40	Running Motors					26	
M41	PT100 Temperature			Deg. C	1000.0	27	
M42	Latest Fault Code					28	
M43	RTC Battery Status				0	583	0 = Not Installed 1 = Installed 2 = Change Battery 3 = OverVoltage
M44	Instant Motor Power			kW		1686	
M45	Energy Savings			Varies	0.000	2120	
M46	Control Board DIDO Status					2209	
M47	SlotA DIDO Status					2210	
M48	SlotB DIDO Status					2211	
M49	Application Status Word					29	
M50	Standard Status Word					2414	
M51	Output			Varies		2445	
M52	Reference			Varies		2447	
M53	Total MWh Count			Mwh		601	
M54	Total Power Day Count					603	
M55	Total Power Hr Count					606	
M56	Trip MWh Count			Mwh		604	
M57	Trip Power Day Count					636	
M58	Trip Power Hr Count					637	
M59	Total Run time Count			h		2827	
M60	Numbers Of Start					2830	
M61	Trip Run Time Count			h		2829	
M62	FB Status Word					2101	
M63	FB Ctrol Word					2001	
M64	FB Speed Reference	0.00	100.00	%		2003	
M65	Multi-monitoring				2, 1, 3, 2, 1, 3, 2, 1, 3	1753	

- Notes:**
- ① Parameter value can only be changed after the drive has stopped.
  - ② Parameter value will be set to be default when changing macros.
  - ③ Input function is level sensed.
  - ④ Input function is edge sensed.
  - ⑤ Input function is edge sensed when using StartP/StopP start logic.

## Parameters

**Table 101. Basic parameters—P1.**

Code	Parameter	Min.	Max.	Unit	Default	ID	Note
P1.1	Min Frequency	0.00	See Par ID 102	Hz	0.00	101	
P1.2 ①	Max Frequency	See Par ID 101	400.00	Hz	MaxFreqMFG	102	
P1.3	Accel Time 1	0.1	3000.0	s	3.0	103	
P1.4	Decel Time 1	0.1	3000.0	s	3.0	104	
P1.5 ①	Motor Nom Current	DriveNomCurrCT*1/10	DriveNomCurrCT*2	A	DriveNomCurrCT	486	
P1.6 ①	Motor Nom Speed	300	24000	rpm	MotorNomSpeedMFG	489	
P1.7 ①	Motor PF	0.30	1.00		0.85	490	
P1.8 ①	Motor Nom Voltage	180	690	V	MotorNomVoltMFG	487	
P1.9 ①	Motor Nom Frequency	8.00	400.00	Hz	MotorNomFreqMFG	488	
P1.10	Power Up Local Remote Select				0	1685	0 = Hold Last 1 = Local Control 2 = Remote control
P1.11	Remote 1 Control Place				0	135	0 = I/O Terminal Start 1 1 = Fieldbus 2 = I/O Terminal Start 2 3 = Keypad
P1.12	Local Control Place				0	1695	0 = Keypad 1 = I/O Terminal Start 1 2 = I/O Terminal Start 2 3 = Fieldbus
P1.13	Bumpless Enable				0	24620	0 = Disabled 1 = Enabled
P1.14 ①②	Local Reference				6	136	0 = AI1 1 = AI2 2 = Slot A: AI1 3 = Slot B: AI1 4 = AI1 Joystick 5 = AI2 Joystick 6 = Keypad 7 = Fieldbus Ref 9 = Max Frequency 10 = AI1 + AI2 11 = AI1 - AI2 12 = AI2 - AI1 13 = AI1 * AI2 14 = AI1 or AI2 15 = MIN(AI1,AI2) 16 = MAX(AI1,AI2) 17 = PID1 Control Output 18 = PID2 Control Output
P1.15 ①②	Remote 1 Reference				0	137	See Par ID 136
P1.16 ①	Reverse Enable				1	1679	See Par ID 2462
P1.17	Run Delay Time	0	32500	s	0	2423	
P1.18 ①	HOA Source				0	2465	0 = Disabled 1 = IO Terminal 2 = Keypad
P1.19 ①	Minimum Run Time	0	32500	s	0	1813	
P1.20	Frequency reference upper limit	See Par ID 101	See Par ID 102	Hz	50.00	2840	
P1.21	Frequency reference upper limit source				0	2841	0 = Not Used 1 = Freq Ref Upper 2 = AI1 3 = AI2

- Notes:**
- ① Parameter value can only be changed after the drive has stopped.
  - ② Parameter value will be set to be default when changing macros.
  - ③ Input function is level sensed.
  - ④ Input function is edge sensed.
  - ⑤ Input function is edge sensed when using StartP/StopP start logic.

## Analog input

**Table 102. Basic setting—P2.1.**

Code	Parameter	Min.	Max.	Unit	Default	ID	Note
P2.1.1	AI Ref Scale Min Value	0.00	See Par ID 145	Hz	0.00	144	
P2.1.2	AI Ref Scale Max Value	See Par ID 144	400.00	Hz	0.00	145	

**Table 103. AI1 settings—P2.2.**

Code	Parameter	Min.	Max.	Unit	Default	ID	Note
P2.2.1	AI1 Mode				1	222	0 = 0–20 mA 1 = 0–10 V
P2.2.2	AI1 Signal Range				0	175	0 = 0–100%/0–20 mA/0–10 V 1 = 20–100%/4–20 mA/2–10 V 2 = Customized
P2.2.3	AI1 Custom Min	0.00	See Par ID 177	%	0.00	176	
P2.2.4	AI1 Custom Max	See Par ID 176	100.00	%	100.00	177	
P2.2.5	AI1 Filter Time	0.00	10.00	s	0.10	174	
P2.2.6	AI1 Signal Invert				0	181	0 = Not Inverted 1 = Inverted
P2.2.7	AI1 Joystick Hyst	0.00	20.00	%	0.00	178	
P2.2.8	AI1 Sleep Limit	0.00	100.00	%	0.00	179	
P2.2.9	AI1 Sleep Delay	0.00	320.00	s	0.00	180	
P2.2.10	AI1 Joystick Offset	-50.00	50.00	%	0.00	133	

**Table 104. AI2 settings—P2.3.**

Code	Parameter	Min.	Max.	Unit	Default	ID	Note
P2.3.1	AI2 Mode				0	223	0 = 0–20 mA 1 = 0–10 V 2 = –10 to +10 V
P2.3.2	AI2 Signal Range				1	183	0 = 0–100%/0–20 mA/0–10 V/–10 to 10 V 1 = 20–100%/4–20 mA/2–10 V/–6- to 10 V 2 = Customized
P2.3.3	AI2 Custom Min	0.00	See Par ID 185	%	0.00	184	
P2.3.4	AI2 Custom Max	See Par ID 184	100.00	%	100.00	185	
P2.3.5	AI2 Filter Time	0.00	10.00	s	0.10	182	
P2.3.6	AI2 Signal Invert				0	189	See Par ID 181
P2.3.7	AI2 Joystick Hyst	0.00	20.00	%	0.00	186	
P2.3.8	AI2 Sleep Limit	0.00	100.00	%	0.00	187	
P2.3.9	AI2 Sleep Delay	0.00	320.00	s	0.00	188	
P2.3.10	AI2 Joystick Offset	-50.00	50.00	%	0.00	134	

- Notes:**
- ① Parameter value can only be changed after the drive has stopped.
  - ② Parameter value will be set to be default when changing macros.
  - ③ Input function is level sensed.
  - ④ Input function is edge sensed.
  - ⑤ Input function is edge sensed when using StartP/StopP start logic.

## Chapter 7—Multi-PID application

**Table 105. Fine adjust—P2.4.**

Code	Parameter	Min.	Max.	Unit	Default	ID	Note
P2.4.1 ①	Fine Tuning Input				0	2484	0 = Not Used 1 = AI1 2 = AI2 3 = Slot A: AI1 4 = Slot B: AI1 5 = Fieldbus
P2.4.2 ①	Fine Tuning Min	0.0	100.0	%	0.0	2485	
P2.4.3 ①	Fine Tuning Max	0.0	100.0	%	0.0	2486	

**Table 106. Digital input—P3.**

Code	Parameter	Min.	Max.	Unit	Default	ID	Note
P3.1 ①	IO Terminal 1 Start Stop Logic				0	143	0 = Forward - Reverse 1 = Start - Reverse 2 = Start - Enable 3 = 3 Wire Control
P3.2 ②③	IO Terminal 1 Start Signal 1				2	190	0 = DigIN:NormallyOpen 1 = DigIN:NormallyClose 2 = DigIN: 1 3 = DigIN: 2 4 = DigIN: 3 5 = DigIN: 4 6 = DigIN: 5 7 = DigIN: 6 8 = DigIN: 7 9 = DigIN: 8 10 = DigIN: A: IO1: 1 11 = DigIN: A: IO1: 2 12 = DigIN: A: IO1: 3 13 = DigIN: A: IO5: 1 14 = DigIN: A: IO5: 2 15 = DigIN: A: IO5: 3 16 = DigIN: A: IO5: 4 17 = DigIN: A: IO5: 5 18 = DigIN: A: IO5: 6 19 = DigIN: B: IO1: 1 20 = DigIN: B: IO1: 2 21 = DigIN: B: IO1: 3 22 = DigIN: B: IO5: 1 23 = DigIN: B: IO5: 2 24 = DigIN: B: IO5: 3 25 = DigIN: B: IO5: 4 26 = DigIN: B: IO5: 5 27 = DigIN: B: IO5: 6 28 = Time Channel 1 29 = Time Channel 2 30 = Time Channel 3 31 = RO1 Function 32 = RO2 Function 33 = RO3 Function 34 = Virtual RO1 Function 35 = Virtual RO2 Function
P3.3 ②⑤	IO Terminal 1 Start Signal 2				3	191	See Par ID 190
P3.4 ①	Thermistor Input Select				0	881	0 = Digital Input 1 = Thermistor Input
P3.5 ②③	Reverse				0	198	See Par ID 190
P3.6 ②③	Ext. Fault 1 NO				4	192	See Par ID 190
P3.7 ②③	Ext. Fault 1 NC				1	193	See Par ID 190
P3.8 ②④	Fault Reset				5	200	See Par ID 190
P3.9 ②③	Run Enable				1	194	See Par ID 190
P3.10 ②③	Preset Speed B0				6	205	See Par ID 190

- Notes:**
- ① Parameter value can only be changed after the drive has stopped.
  - ② Parameter value will be set to be default when changing macros.
  - ③ Input function is level sensed.
  - ④ Input function is edge sensed.
  - ⑤ Input function is edge sensed when using StartP/StopP start logic.

**Table 106. Digital input—P3, continued.**

Code	Parameter	Min.	Max.	Unit	Default	ID	Note
P3.11 ②③	Preset Speed B1				7	206	See Par ID 190
P3.12 ②③	Preset Speed B2				0	207	See Par ID 190
P3.13 ②③	PID1 Control Enable				1	550	See Par ID 190
P3.14 ②③	PID2 Control Enable				1	553	See Par ID 190
P3.15 ②③	Accel/Decel Time Set				0	195	See Par ID 190
P3.16 ②③	Accel/Decel Prohibit				0	201	See Par ID 190
P3.17 ②④	No Access To Param				0	215	See Par ID 190
P3.21 ②③	Remote Control				9	196	See Par ID 190
P3.22 ②③	Local Control				0	197	See Par ID 190
P3.23 ②③	Remote 1/2 Select				0	209	See Par ID 190
P3.24 ②③	Second Motor Para Select				0	217	See Par ID 190
P3.25 ②③	Force Bypass				0	218	See Par ID 190
P3.26 ②③	DC Brake Active				0	202	See Par ID 190
P3.27 ②③	Smoke Mode				0	219	See Par ID 190
P3.28 ②③	Fire Mode				0	220	See Par ID 190
P3.29 ②③	Fire Mode Ref 1/2 Select				0	221	See Par ID 190
P3.30 ②③	PID1 Set Point Select				0	351	See Par ID 190
P3.31 ②③	PID2 Set Point Select				0	352	See Par ID 190
P3.32 ②③	Jog Enable				0	199	See Par ID 190
P3.33 ③	Start Timer 1				0	224	See Par ID 190
P3.34 ③	Start Timer 2				0	225	See Par ID 190
P3.35 ③	Start Timer 3				0	226	See Par ID 190
P3.36 ②③	AI Ref Source Select				0	208	See Par ID 190
P3.37 ②③	Motor Interlock 1				0	210	See Par ID 190
P3.38 ②③	Motor Interlock 2				0	211	See Par ID 190
P3.39 ②③	Motor Interlock 3				0	212	See Par ID 190
P3.40 ②③	Motor Interlock 4				0	213	See Par ID 190
P3.41 ②③	Motor Interlock 5				0	214	See Par ID 190
P3.42 ②③	Ext Fault-AR				1	747	See Par ID 190
P3.43 ②③	Bypass Overload				0	1246	See Par ID 190
P3.44 ②③	Fire Mode Direction Invert				0	2119	See Par ID 190
P3.45 ①	IO Terminal 2 Start Stop Logic				0	2206	See Par ID 143
P3.46 ②⑤	IO Terminal 2 Start Signal 1				2	2207	See Par ID 190
P3.47 ②⑤	IO Terminal 2 Start Signal 2				3	2208	See Par ID 190
P3.48 ②③	Ext. Fault 2 NO				0	2293	See Par ID 190
P3.49 ②③	Ext. Fault 2 NC				1	2294	See Par ID 190
P3.50 ②③	Ext. Fault 3 NO				0	2295	See Par ID 190
P3.51 ②③	Ext. Fault 3 NC				1	2296	See Par ID 190

- Notes:**
- ① Parameter value can only be changed after the drive has stopped.
  - ② Parameter value will be set to be default when changing macros.
  - ③ Input function is level sensed.
  - ④ Input function is edge sensed.
  - ⑤ Input function is edge sensed when using StartP/StopP start logic.

## Chapter 7—Multi-PID application

**Table 106. Digital input—P3, continued.**

Code	Parameter	Min.	Max.	Unit	Default	ID	Note
P3.52	Ext. Fault 1 Text				0	2297	0 = External Fault 1 = Vibration Cut out 2 = High Motor temp 3 = Low Pressure 4 = High Pressure 5 = Low Water 6 = Damper Interlock 7 = Run Enable 8 = Freeze Stat Trip 9 = Smoke Detect 10 = Seal Leakage 11 = Rod Breakage 12 = Torque Limit
P3.53	Ext. Fault 2 Text				1	2298	See Par ID 2297
P3.54	Ext. Fault 3 Text				2	2299	See Par ID 2297
P3.55 ②④	Parameter Set1/2 Sel				0	2312	See Par ID 190
P3.56 ②③	Deragging Enable				0	2394	See Par ID 190
P3.57 ②③	HOA On/Off				1	2395	See Par ID 190
P3.58 ③	Multi-pump Mode 1/2 Select				0	2658	See Par ID 190
P3.59 ②③	OP Cont Interlock NO				4	2801	See Par ID 190
P3.60 ②③	OP Cont Interlock NC				1	2802	See Par ID 190
P3.61 ③	CP Interlock NC				1	2894	See Par ID 190

**Table 107. Analog output—P4.**

Code	Parameter	Min.	Max.	Unit	Default	ID	Note
P4.1	A01 Mode				0	227	See Par ID 222
P4.2 ②	A01 Function				1	146	0 = Not Used 1 = Output Frequency 2 = Freq Reference 3 = Motor Speed 4 = Motor Current 5 = Motor Torque (0-Nom) 6 = Motor Power 7 = Motor Voltage 8 = DC-Bus Voltage 9 = PID1 Setpoint 10 = PID1 Feedback 1 11 = PID1 Feedback 2 12 = PID1 Control Error Value 13 = PID1 Control Output 14 = PID2 Setpoint 15 = PID2 Feedback 1 16 = PID2 Feedback 2 17 = PID2 Control Error Value 18 = PID2 Control Output 19 = AI1 20 = AI2 21 = Output Freq (-2-+2N) 22 = Motor Torque (-2-+2N) 23 = Motor Power (-2-+2N) 24 = PT100 Temperature 25 = FB Process Data Input 1 26 = FB Process Data Input 2 27 = FB Process Data Input 3 28 = FB Process Data Input 4 29 = FB Process Data Input 5 30 = FB Process Data Input 6 31 = FB Process Data Input 7 32 = FB Process Data Input 8

- Notes:**
- ① Parameter value can only be changed after the drive has stopped.
  - ② Parameter value will be set to be default when changing macros.
  - ③ Input function is level sensed.
  - ④ Input function is edge sensed.
  - ⑤ Input function is edge sensed when using StartP/StopP start logic.



**Table 107. Analog output—P4, continued.**

Code	Parameter	Min.	Max.	Unit	Default	ID	Note
P4.2 ②, continued	AO1 Function				1	146	33 = SlotA PT100 Temp Channel 1 34 = SlotA PT100 Temp Channel 2 35 = SlotA PT100 Temp Channel 3 36 = SlotB PT100 Temp Channel 1 37 = SlotB PT100 Temp Channel 2 38 = SlotB PT100 Temp Channel 3 39 = User Defined Output 40 = Motor Current (-2-+2N)
P4.3	AO1 Minimum				1	149	0 = 0V / 0 mA 1 = 2V / 4 mA
P4.4	AO1 Filter Time	0.00	10.00	s	1.00	147	
P4.5	AO1 Scale	10	1000	%	100	150	
P4.6	AO1 Inversion				0	148	See Par ID 181
P4.7	AO1 Offset	-100.00	100.00	%	0.00	173	
P4.8	AO2 Mode				0	228	See Par ID 222
P4.9 ②	AO2 Function				4	229	See Par ID 146
P4.10	AO2 Minimum				1	232	See Par ID 149
P4.11	AO2 Filter Time	0.00	10.00	s	1.00	230	
P4.12	AO2 Scale	10	1000	%	100	233	
P4.13	AO2 Inversion				0	231	See Par ID 181
P4.14	AO2 Offset	-100.00	100.00	%	0.00	234	

**Table 108. Digital output—P5.**

Code	Parameter	Min.	Max.	Unit	Default	ID	Note
P5.1 ②	DO1 Function				1	151	0 = Not Used 1 = Ready 2 = Run 3 = Fault 4 = Fault Invert 5 = Warning 6 = Reversed 7 = At Speed 8 = Zero Frequency 9 = Freq Limit 1 Superv 10 = Freq Limit 2 Superv 11 = PID1 Superv 12 = PID2 Superv 13 = OverHeat Fault 14 = OverCurrent Regular 15 = OverVoltage Regular 16 = UnderVoltage Regular 17 = 4mA Ref Fault/Warning 20 = Torq Limit Superv 21 = Ref Limit Superv 22 = Control from I/O 23 = Un-Requested Rotation Direction 24 = Thermistor Fault Output 25 = Fire Mode 26 = In Bypass Mode 27 = Ext Fault/Warning 28 = Remote Control 29 = Jog Speed Select

- Notes:**
- ① Parameter value can only be changed after the drive has stopped.
  - ② Parameter value will be set to be default when changing macros.
  - ③ Input function is level sensed.
  - ④ Input function is edge sensed.
  - ⑤ Input function is edge sensed when using StartP/StopP start logic.

## Chapter 7—Multi-PID application

**Table 108. Digital output—P5, continued.**

Code	Parameter	Min.	Max.	Unit	Default	ID	Note
P5.1 ②, continued	DO1 Function				1	151	30 = Motor Therm Protection 31 = FB Digital Input 1 32 = FB Digital Input 2 33 = FB Digital Input 3 34 = FB Digital Input 4 35 = Damper Control 36 = TC1 Status 37 = TC2 Status 38 = TC3 Status 39 = In E-Stop 40 = Power Limit Superv 41 = Temp Limit Superv 42 = Analog Input Superv 43 = Motor 1 Control 44 = Motor 2 Control 45 = Motor 3 Control 46 = Motor 4 Control 47 = Motor 5 Control 49 = PID1 Sleep 50 = PID2 Sleep 51 = Motor Current 1 Supv 52 = Motor Current 2 Supv 53 = Second AI Limit Supv 54 = DC Charge Switch Close 55 = Preheat Active 56 = Cold Weather Active 57 = Prime Pump Active 58 = 2th Stage Ramp Frequency Active 59 = STO Fault Output 60 = Run Bypass/Drive 61 = Bypass Overload 62 = Bypass Run 63 = Auto Local On COM Fault 64 = FieldBus RTU Fault 65 = FieldBus TCP Fault 66 = FieldBus MSTP Fault 67 = FieldBus EIP Fault 68 = FieldBus SlotA Fault 69 = FieldBus SlotB Fault 70 = FieldBus SWD Fault 71 = Jockey Pump Active 72 = Lube Pump Active 73 = PID1 Low Feedback 74 = PID1 High Feedback 75 = PID2 Low Feedback 76 = PID2 High Feedback 77 = Master in MPFC 78 = CP Interlock Fault
P5.2 ②	RO1 Function				2	152	See Par ID 151
P5.3 ②	RO2 Function				3	153	See Par ID 151
P5.4 ②	RO3 Function				7	538	See Par ID 151
P5.5 ②	Virtual RO1 Function				0	2463	See Par ID 151
P5.6 ②	Virtual RO2 Function				0	2464	See Par ID 151
P5.7 ②	Freq Limit 1 Supv				0	154	0 = No Limit 1 = Low Limit Superv 2 = High Limit Superv
P5.8	Freq Limit 1 Supv Val	0.00	See Par ID 102	Hz	0.00	155	
P5.9 ②	Freq Limit 2 Supv				0	157	0 = No Limit 1 = Low Limit Superv 2 = High Limit Superv
P5.10	Freq Limit 2 Supv Val	0.00	See Par ID 102	Hz	0.00	158	

- Notes:**
- ① Parameter value can only be changed after the drive has stopped.
  - ② Parameter value will be set to be default when changing macros.
  - ③ Input function is level sensed.
  - ④ Input function is edge sensed.
  - ⑤ Input function is edge sensed when using StartP/StopP start logic.

**Table 108. Digital output—P5, continued.**

Code	Parameter	Min.	Max.	Unit	Default	ID	Note
P5.11 ②	Torque Limit Supv				0	159	0 = No Limit 1 = Low Limit Superv 2 = High Limit Superv
P5.12 ②	Torque Limit Supv Val	-1000.0	1000.0	%	100.0	160	
P5.13	Ref Limit Supv				0	161	0 = No Limit 1 = Low Limit Superv 2 = High Limit Superv
P5.14	Ref Limit Supv Val	0.00	See Par ID 102	Hz	0.00	162	
P5.17	Temp Limit Supv				0	165	See Par ID 161
P5.18	Temp Limit Supv Val	-10.0	75.0	Deg. C	40.0	166	
P5.19	Power Limit Supv				0	167	See Par ID 161
P5.20	Power Limit Supv Val	-200.0	200.0	%	0.0	168	
P5.21	AI Supv Select				0	170	0 = AI1 1 = AI2
P5.22	AI Limit Supv				0	171	See Par ID 161
P5.23	AI Limit Supv Val	0.00	100.00	%	0.00	172	
P5.24	PID1 Superv Enable				0	1346	See Par ID 2462
P5.25	PID1 Superv Upper Limit	See Par ID 1298	See Par ID 1300	Varies	0.00	1347	
P5.26	PID1 Superv Lower Limit	See Par ID 1298	See Par ID 1300	Varies	0.00	1349	
P5.27	PID1 Superv Delay	0	3000	s	0	1351	
P5.28	PID2 Superv Enable				0	1408	See Par ID 2462
P5.29	PID2 Superv Upper Limit	See Par ID 1360	See Par ID 1362	Varies	0.00	1409	
P5.30	PID2 Superv Lower Limit	See Par ID 1360	See Par ID 1362	Varies	0.00	1411	
P5.31	PID2 Superv Delay	0	3000	s	0	1413	
P5.32	RO1 On Delay	0.0	320.0	s	0.0	2112	
P5.33	RO1 Off Delay	0.0	320.0	s	0.0	2113	
P5.34	RO2 On Delay	0.0	320.0	s	0.0	2114	
P5.35	RO2 Off Delay	0.0	320.0	s	0.0	2115	
P5.36	RO3 On Delay	0.0	320.0	s	0.0	2116	
P5.37	RO3 Off Delay	0.0	320.0	s	0.0	2117	
P5.38	RO3 Reverse				0	2118	0 = No 1 = Yes
P5.39 ②	Motor Current 1 Supv				0	2189	See Par ID 159
P5.40	Motor Current 1 Supv Value	0.0	DriveNomCurrCT*2	A	DriveNomCurrCT	2190	
P5.41 ②	Motor Current 2 Supv				0	2191	See Par ID 159
P5.42	Motor Current 2 Supv Value	0.0	DriveNomCurrCT*2	A	DriveNomCurrCT	2192	
P5.43	Second AI Supv Select				0	2193	See Par ID 170
P5.44	Second AI Limit Supv				0	2194	See Par ID 161
P5.45	Second AI Limit Supv Val	0.00	100.00	%	0.00	2195	
P5.46	Motor Current 1 Supv Hyst	0.1	1.0	A	0.1	2196	
P5.47	Motor Current 2 Supv Hyst	0.1	1.0	A	0.1	2197	
P5.48	AI Supv Hyst	1.00	10.00	%	1.00	2198	
P5.49	Second AI Supv Hyst	1.00	10.00	%	1.00	2199	
P5.50	Freq Limit 1 Supv Hyst	0.10	1.00	Hz	0.10	2200	

- Notes:**
- ① Parameter value can only be changed after the drive has stopped.
  - ② Parameter value will be set to be default when changing macros.
  - ③ Input function is level sensed.
  - ④ Input function is edge sensed.
  - ⑤ Input function is edge sensed when using StartP/StopP start logic.

## Chapter 7—Multi-PID application

**Table 108. Digital output—P5, continued.**

Code	Parameter	Min.	Max.	Unit	Default	ID	Note
P5.51	Freq Limit 2 Supv Hyst	0.10	1.00	Hz	0.10	2201	
P5.52	Torque Limit Supv Hyst	1.0	5.0	%	1.0	2202	
P5.53	Ref Limit Supv Hyst	0.10	1.00	Hz	0.10	2203	
P5.54	Temp Limit Supv Hyst	1.0	10.0	Deg. C	1.0	2204	
P5.55	Power Limit Supv Hyst	0.1	10.0	%	0.1	2205	
P5.56	Virtual RO1 On Delay	0.0	320.0	s	0.0	2848	
P5.57	Virtual RO1 Off Delay	0.0	320.0	s	0.0	2849	
P5.58	Virtual RO2 On Delay	0.0	320.0	s	0.0	2850	
P5.59	Virtual RO2 Off Delay	0.0	320.0	s	0.0	2851	

**Table 109. Drive control—P7.**

Code	Parameter	Min.	Max.	Unit	Default	ID	Note
P7.1	Remote 2 Control Place				1	138	See Par ID 135
P7.2 ①②	Remote 2 Reference				7	139	See Par ID 136
P7.3	Keypad Reference	See Par ID 101	See Par ID 102	Hz	0.00	141	
P7.4	Keypad Direction				0	116	0 = Forward 1 = Reverse
P7.5	Keypad Stop				1	114	0 = Enabled-Keypad Operation 1 = Always Enabled
P7.6	Jog Reference	0.00	See Par ID 102	Hz	5.00	117	
P7.9	Start Mode				0	252	0 = Ramp 1 = Flying Start From Stop Frequency 2 = Flying Start From Max Frequency
P7.10	Stop Mode				1	253	0 = Coasting 1 = Ramp
P7.11	Ramp 1 Shape	0.0	10.0	s	0.0	247	
P7.12	Ramp 2 Shape	0.0	10.0	s	0.0	248	
P7.13	Accel Time 2	0.1	3000.0	s	10.0	249	
P7.14	Decel Time 2	0.1	3000.0	s	10.0	250	
P7.15	Skip F1 Low Limit	0.00	See Par ID 257	Hz	0.00	256	
P7.16	Skip F1 High Limit	See Par ID 256	400.00	Hz	0.00	257	
P7.17	Skip F2 Low Limit	0.00	See Par ID 259	Hz	0.00	258	
P7.18	Skip F2 High Limit	See Par ID 258	400.00	Hz	0.00	259	
P7.19	Skip F3 Low Limit	0.00	See Par ID 261	Hz	0.00	260	
P7.20	Skip F3 High Limit	See Par ID 260	400.00	Hz	0.00	261	
P7.21	Skip Range Ramp Factor	0.1	10.0		1.0	264	
P7.22	Power Loss Function				0	267	0 = Disabled 1 = Decel Mode 2 = Coast Mode
P7.23	Power Loss Time	0.3	5.0	s	2.0	268	
P7.24	Currency				0	2122	0 = \$ 1 = £ 2 = € 3 = ¥ 4 = Rs 5 = R\$ 6 = Fr 7 = kr
P7.25	Energy Cost			Varies	0.00	2123	

- Notes:**
- ① Parameter value can only be changed after the drive has stopped.
  - ② Parameter value will be set to be default when changing macros.
  - ③ Input function is level sensed.
  - ④ Input function is edge sensed.
  - ⑤ Input function is edge sensed when using StartP/StopP start logic.

**Table 109. Drive control—P7, continued.**

Code	Parameter	Min.	Max.	Unit	Default	ID	Note
P7.26	Data Type				0	2124	0 = Cumulative 1 = Daily Avg 2 = Weekly Avg 3 = Monthly Avg 4 = Yearly Avg
P7.27	Energy Savings Reset					2125	0 = Not Reset 1 = Reset
P7.28 ①	2nd Stage Ramp Frequency	See Par ID 101	See Par ID 102	Hz	30.00	2444	
P7.29	Change PhaseSequence Motor				0	2515	0 = Change Disable 1 = Change Enable
P7.30	Run Remove Stop Mode				0	2667	See Par ID 253

**Table 110. Motor control—P8.**

Code	Parameter	Min.	Max.	Unit	Default	ID	Note
P8.1 ①②	Motor Control Mode				0	287	0 = Freq Control 1 = Speed Control
P8.2 ①	Current Limit	DriveNomCurrCT*1/10	DriveNomCurrCT*2	A	DriveNomCurrVT	107	
P8.3 ①	V/Hz Optimization				0	109	See Par ID 2462
P8.4 ①	V/Hz Ratio				0	108	0 = Linear 1 = Squared 2 = Programmable 3 = Linear + Flux Optimization
P8.5 ①	Field Weakening Point	8.00	400.00	Hz	FieldWeakPointMFG	289	
P8.6 ①	Voltage at FWP	10.00	200.00	%	100.00	290	
P8.7 ①	V/Hz Mid Frequency	0.00	See Par ID 289	Hz	VHzCurveMidFreqMFG	291	
P8.8 ①	V/Hz Mid Voltage	0.00	100.00	%	100.00	292	
P8.9 ①	Zero Frequency Voltage	0.00	40.00	%	0.00	293	
P8.10	Switching Frequency	MinSwitchFreq	MaxSwitchFreq	kHz	DefaultSwitchFreqCT	2522	
P8.11	Sine Filter Enable				0	1665	See Par ID 2462
P8.12 ①	OverVoltage Control				3	294	0 = Disabled 1 = REF + 8Hz 2 = Max Freq 3 = Max Freq + 8Hz
P8.14 ②	Identification				0	299	0 = No Action 1 = Identification Only Stator Resistor 2 = Identification with Run 3 = Identification No Run 4 = Identification Only Inertia
P8.17	Frequency Ramp Out FilterTime Constant	0	3000	ms	0	1585	
P8.50 ①	Stator Resistor	0.001	65.535	ohm	0.001	771	
P8.59	VF Stable Kd	0	3000	%	100	1656	
P8.60	VF Stable Kq	0	3000	%	100	1657	
P8.61 ①	Overmodulation Enable				0	2835	See Par ID 2462
P8.71	Slip Compensation Coefficient	0	500	%	100	1664	

- Notes:**
- ① Parameter value can only be changed after the drive has stopped.
  - ② Parameter value will be set to be default when changing macros.
  - ③ Input function is level sensed.
  - ④ Input function is edge sensed.
  - ⑤ Input function is edge sensed when using StartP/StopP start logic.

## Chapter 7—Multi-PID application

**Table 111. Protections—P9.**

Code	Parameter	Min.	Max.	Unit	Default	ID	Note
P9.1 ①	4mA Input Fault				0	306	0 = No Action 1 = Warning 2 = Warning: Previous Freq 3 = Warning: Preset Freq 4 = Fault 5 = Fault, Coast
P9.2 ①	4mA Fault Frequency	0.00	See Par ID 102	Hz	0.00	331	
P9.3 ①	External Fault				2	307	0 = No Action 1 = Warning 2 = Fault 3 = Fault, Coast
P9.4 ①	Input Phase Fault				2	332	0 = No Action 1 = Warning 2 = Fault 3 = Fault, Coast 4 = Single Phase Power Limit
P9.5 ①	Uvolt Fault Response				2	330	See Par ID 307
P9.6 ①	Output Phase Fault				2	308	See Par ID 307
P9.7 ①	Ground Fault				2	309	See Par ID 307
P9.8 ①	Motor Thermal Protection				2	310	See Par ID 307
P9.9	Motor Thermal F0 Current	0.0	150.0	%	100.0	311	
P9.11 ①	Stall Protection				0	313	See Par ID 307
P9.12	Stall Current Limit	0.1	ActiveMotor NomCurr*2	A	ActiveMotor NomCurr*13/10	314	
P9.13	Stall Time Limit	1.0	120.0	s	15.0	315	
P9.14	Stall Frequency Limit	1.00	See Par ID 102	Hz	25.00	316	
P9.15 ①	Underload Protection				0	317	See Par ID 307
P9.16	Underload Fnom Torque	10.0	150.0	%	50.0	318	
P9.17	Underload F0 Torque	5.0	150.0	%	10.0	319	
P9.18	Underload Time Limit	2.00	600.00	s	20.00	320	
P9.19 ①	Thermistor Fault Response				2	333	See Par ID 307
P9.20	Line Start Lockout				2	750	0 = Disabled, No Change 1 = Enable, No Change 2 = Disabled, Changed 3 = Enable, Changed
P9.21 ①	Fieldbus Fault Response				2	334	0 = No Action 1 = Warning 2 = Fault 3 = Fault, Coast 4 = Warning, Coast 5 = Warning, Auto Switch To Local 6 = Warning, Auto Switch To Preset Speed 1
P9.22 ①	OPTCard Fault Response				2	335	See Par ID 307
P9.23 ①	Unit Under Temp Prot				2	1564	See Par ID 307
P9.24	AR Wait Time	1.00	300.00	s	1.00	321	
P9.25	AR Trail Time	0.00	600.00	s	30.00	322	
P9.26	AR Start Function				0	323	0 = Flying Start From Stop Frequency 1 = Ramp 2 = Flying Start From Max Frequency

- Notes:**
- ① Parameter value can only be changed after the drive has stopped.
  - ② Parameter value will be set to be default when changing macros.
  - ③ Input function is level sensed.
  - ④ Input function is edge sensed.
  - ⑤ Input function is edge sensed when using StartP/StopP start logic.

**Table 111. Protections—P9, continued.**

Code	Parameter	Min.	Max.	Unit	Default	ID	Note
P9.27	Undervoltage Attempts	0	10		1	324	
P9.28	OverVoltage Attempts	0	10		1	325	
P9.29	OverCurrent Attempts	0	3		1	326	
P9.30	4mA Fault Attempts	0	10		1	327	
P9.31	Motor Temp Fault Attempts	0	10		1	329	
P9.32	External Fault Attempts	0	10		1	328	
P9.33	Underload Attempts	0	10		1	336	
P9.34 ①	RTC Fault				1	955	See Par ID 307
P9.35 ①	PT100 Fault Response				2	337	See Par ID 307
P9.36 ①	Replace Battery Fault Response				1	1256	See Par ID 307
P9.37 ①	Replace Fan Fault Response				1	1257	See Par ID 307
P9.38 ①	IP Address Confliction Resp				1	1678	See Par ID 307
P9.39	Cold Weather Mode				0	2126	See Par ID 2462
P9.40	Cold Weather Volt. Level	0.0	20.0	%	2.0	2127	
P9.41	Cold Weather Time Out	0	10	min	3	2128	
P9.42	Cold Weather Password					2129	
P9.43	Under Temp Fault Override					2130	See Par ID 2118
P9.44	Ground Fault Limit	0	30	%	15	2158	
P9.45 ①	Keypad Comm Fault Response				2	2157	See Par ID 307
P9.46	Preheat Mode				0	2159	See Par ID 2462

- Notes:**
- ① Parameter value can only be changed after the drive has stopped.
  - ② Parameter value will be set to be default when changing macros.
  - ③ Input function is level sensed.
  - ④ Input function is edge sensed.
  - ⑤ Input function is edge sensed when using StartP/StopP start logic.

## Chapter 7—Multi-PID application

**Table 111. Protections—P9, continued.**

Code	Parameter	Min.	Max.	Unit	Default	ID	Note
P9.47 ②	Preheat Control Source				31	2160	0 = DigIN:NormallyOpen 1 = DigIN:NormallyClose 2 = DigIN: 1 3 = DigIN: 2 4 = DigIN: 3 5 = DigIN: 4 6 = DigIN: 5 7 = DigIN: 6 8 = DigIN: 7 9 = DigIN: 8 10 = DigIN: A: IO1: 1 11 = DigIN: A: IO1: 2 12 = DigIN: A: IO1: 3 13 = DigIN: A: IO5: 1 14 = DigIN: A: IO5: 2 15 = DigIN: A: IO5: 3 16 = DigIN: A: IO5: 4 17 = DigIN: A: IO5: 5 18 = DigIN: A: IO5: 6 19 = DigIN: B: IO1: 1 20 = DigIN: B: IO1: 2 21 = DigIN: B: IO1: 3 22 = DigIN: B: IO5: 1 23 = DigIN: B: IO5: 2 24 = DigIN: B: IO5: 3 25 = DigIN: B: IO5: 4 26 = DigIN: B: IO5: 5 27 = DigIN: B: IO5: 6 28 = Time Channel 1 29 = Time Channel 2 30 = Time Channel 3 31 = Drive Temperature 32 = SlotA PT100 Temp Channel 1 33 = SlotA PT100 Temp Channel 2 34 = SlotA PT100 Temp Channel 3 35 = SlotA Max PT100 Temp 36 = SlotB PT100 Temp Channel 1 37 = SlotB PT100 Temp Channel 2 38 = SlotB PT100 Temp Channel 3 39 = SlotB Max PT100 Temp 40 = SlotA and SlotB Max PT100 Temp
P9.48	Preheat Enter Temp	-20.0	20.0	Deg. C	10.0	2161	
P9.49	Preheat Quit Temp	-10.0	40.0	Deg. C	20.0	2162	
P9.50	Preheat Output Volt	0.0	20.0	%	2.0	2163	
P9.51 ①	PID Feedback AI Loss Response				0	2410	0 = No Action 1 = Warning 2 = Fault 3 = Warning: Preset Freq 4 = Warning: Analog->Net
P9.52 ①	PID Feedback AI Loss Pre Freq	0.00	400.00	Hz	0.00	2402	
P9.53	PID Feedback AI Loss Pipe Fill Loss Level	0.0	1000.0	Varies	0.0	2403	
P9.54	PID Feedback AI Loss PreFreq Timeout	0	6000	s	0	2404	
P9.55	PID Feedback AI Loss Attempts	0	10		1	2405	

- Notes:**
- ① Parameter value can only be changed after the drive has stopped.
  - ② Parameter value will be set to be default when changing macros.
  - ③ Input function is level sensed.
  - ④ Input function is edge sensed.
  - ⑤ Input function is edge sensed when using StartP/StopP start logic.



**Table 111. Protections—P9, continued.**

Code	Parameter	Min.	Max.	Unit	Default	ID	Note
P9.56	STO Fault Response				2	2427	0 = No Action 1 = Warning 2 = Fault
P9.57	Fault Reset Start				0	2483	0 = Follow Run Command 1 = Rising Edge After Fault Reset
P9.58	Warning Operation Mode				1	2657	0 = No Action 1 = Warning, No Store 2 = Warning, Store
P9.59	Fan Protection				2	2664	See Par ID 307
P9.60	Under Voltage Trip Level	DCLinkUnderVolt StopLimit	DCLinkOverVolt StopLimit	V	DCLinkUnderVolt ProtectLimit	2666	
P9.61	OP Cont Interlock Attempts	0	10		1	2803	
P9.62 ①	OP Cont Interlock Protection				2	2831	See Par ID 307
P9.63 ①	CP Interlock Run Protection				2	2895	See Par ID 307
P9.64 ①	CP Interlock Stop Protection				1	2896	0 = No Action 1 = Warning, No Store
P9.65	CP Interlock Attempts	0	10		1	2897	

**Table 112. PID controller 1—P10.**

Code	Parameter	Min.	Max.	Unit	Default	ID	Note
P10.1	PID1 Control Gain	0.00	200.00	%	100.00	1294	
P10.2	PID1 Control ITime	0.00	600.00	s	1.00	1295	
P10.3	PID1 Control DTime	0.00	100.00	s	0.00	1296	
P10.4 ①	PID1 Process Unit				0	1297	0 = % 1 = 1/min 2 = rpm 3 = ppm 4 = pps 5 = l/s 6 = l/min 7 = l/h

- Notes:**
- ① Parameter value can only be changed after the drive has stopped.
  - ② Parameter value will be set to be default when changing macros.
  - ③ Input function is level sensed.
  - ④ Input function is edge sensed.
  - ⑤ Input function is edge sensed when using StartP/StopP start logic.

## Chapter 7—Multi-PID application

**Table 112. PID controller 1—P10, continued.**

Code	Parameter	Min.	Max.	Unit	Default	ID	Note
P10.4 ①②, continued	PID1 Process Unit				0	1297	8 = kg/s 9 = kg/min 10 = kg/h 11 = m <sup>3</sup> /s 12 = m <sup>3</sup> /min 13 = m <sup>3</sup> /h 14 = m/s 15 = mbar 16 = bar 17 = Pa 18 = kPa 19 = mVS 20 = kW 21 = Deg. C 22 = GPM 23 = gal/s 24 = gal/min 25 = gal/h 26 = lb/s 27 = lb/min 28 = lb/h 29 = CFM 30 = ft <sup>3</sup> /s 31 = ft <sup>3</sup> /min 32 = ft <sup>3</sup> /h 33 = ft/s 34 = in wg 35 = ft wg 36 = PSI 37 = lb/in <sup>2</sup> 38 = HP 39 = Deg. F 40 = PA 41 = WVC 42 = HG 43 = ft 44 = m
P10.5	PID1 Process Unit Min	-99999.99	See Par ID 1300	Varies	0.00	1298	
P10.6	PID1 Process Unit Max	See Par ID 1298	99999.99	Varies	100.00	1300	
P10.7	PID1 Process Unit Decimal	0	4		2	1302	
P10.8 ①	PID1 Error Inversion				0	1303	See Par ID 181
P10.9	PID1 Dead Band	0.00	99999.99	Varies	0.00	1304	
P10.10	PID1 Dead Band Delay	0.00	320.00	s	0.00	1306	
P10.11	PID1 Keypad Set Point 1	See Par ID 1298	See Par ID 1300	Varies	0.00	1307	
P10.12	PID1 Keypad Set Point 2	See Par ID 1298	See Par ID 1300	Varies	0.00	1309	
P10.13	PID1 Ramp Time	0.00	300.00	s	0.00	1311	
P10.14 ①②	PID1 Set Point 1 Source				1	1312	0 = Not Used 1 = PID1 Keypad Set Point 1 2 = PID1 Keypad Set Point 2 3 = AI1 4 = AI2 5 = Slot A: AI1 6 = Slot B: AI1 7 = FB Process Data Input 1 8 = FB Process Data Input 2 9 = FB Process Data Input 3 10 = FB Process Data Input 4 11 = FB Process Data Input 5

- Notes:**
- ① Parameter value can only be changed after the drive has stopped.
  - ② Parameter value will be set to be default when changing macros.
  - ③ Input function is level sensed.
  - ④ Input function is edge sensed.
  - ⑤ Input function is edge sensed when using StartP/StopP start logic.

**Table 112. PID controller 1—P10, continued.**

Code	Parameter	Min.	Max.	Unit	Default	ID	Note
P10.14 ①②, continued	PID1 Set Point 1 Source				1	1312	12 = FB Process Data Input 6 13 = FB Process Data Input 7 14 = FB Process Data Input 8 15 = PID2 Output 16 = Multi Drive Network 17 = FB PID1 Set Point 1 18 = FB PID1 Set Point 2
P10.15	PID1 Set Point 1 Min	-200.00	200.00	%	0.00	1313	
P10.16	PID1 Set Point 1 Max	-200.00	200.00	%	100.00	1314	
P10.17 ③	PID1 Set Point 1 Sleep Enable				0	1315	See Par ID 2462
P10.18 ④	PID1 Set Point 1 Sleep Unit Sel				0	2396	0 = Output Frequency 1 = Motor Speed 2 = Motor Current 3 = PID1 Feedback
P10.19	PID1 Set Point 1 Sleep Level			Varies	0.00	2450	
P10.20	PID1 Set Point 1 Sleep Delay	0	3000	s	0	1317	
P10.21	PID1 Set Point 1 Wake Up Level	-99999.99	99999.99	Varies	0.00	1318	
P10.22	PID1 Set Point 1 Boost	-2.0	2.0		1.0	1320	
P10.23 ①②	PID1 Set Point 2 Source				2	1321	See Par ID 1312
P10.24	PID1 Set Point 2 Min	-200.00	200.00	%	0.00	1322	
P10.25	PID1 Set Point 2 Max	-200.00	200.00	%	100.00	1323	
P10.26 ③	PID1 Set Point 2 Sleep Enable				0	1324	See Par ID 2462
P10.27 ④	PID1 Set Point 2 Sleep Unit Sel				0	2397	See Par ID 2396
P10.28	PID1 Set Point 2 Sleep Level			Varies	0.00	2452	
P10.29	PID1 Set Point 2 Sleep Delay	0	3000	s	0	1326	
P10.30	PID1 Set Point 2 Wake Up Level	-99999.99	99999.99	Varies	0.00	1327	
P10.31	PID1 Set Point 2 Boost	-2.0	2.0		1.0	1329	
P10.32 ⑤	PID1 Feedback Function				0	1330	0 = Source 1 1 = SQRT(Source 1) 2 = SQRT(Source 1 - Source 2) 3 = SQRT(Source 1) + SQRT(Source 2) 4 = Source 1 + Source 2 5 = Source 1 - Source 2 6 = MIN(Source 1, Source 2) 7 = MAX(Source 1, Source 2) 8 = MEAN(Source1, Source2) 9 = Source1*Source2
P10.33	PID1 Feedback Gain	-1000.0	1000.0	%	100.0	1331	
P10.34 ①②	PID1 Feedback 1 Source				2	1332	0 = Not Used 1 = AI1 2 = AI2 3 = Slot A: AI1 4 = Slot B: AI1 5 = FB Process Data Input 1 6 = FB Process Data Input 2 7 = FB Process Data Input 3 8 = FB Process Data Input 4 9 = FB Process Data Input 5

- Notes:**
- ① Parameter value can only be changed after the drive has stopped.
  - ② Parameter value will be set to be default when changing macros.
  - ③ Input function is level sensed.
  - ④ Input function is edge sensed.
  - ⑤ Input function is edge sensed when using StartP/StopP start logic.

## Chapter 7—Multi-PID application

**Table 112. PID controller 1—P10, continued.**

Code	Parameter	Min.	Max.	Unit	Default	ID	Note
P10.34 ①②, continued	PID1 Feedback 1 Source				2	1332	10 = FB Process Data Input 6 11 = FB Process Data Input 7 12 = FB Process Data Input 8 13 = PT100 Temperature 14 = PID2 Output 15 = SlotA PT100 Temp Channel 1 16 = SlotA PT100 Temp Channel 2 17 = SlotA PT100 Temp Channel 3 18 = SlotB PT100 Temp Channel 1 19 = SlotB PT100 Temp Channel 2 20 = SlotB PT100 Temp Channel 3 21 = FB PID1 Feedback 1 22 = FB PID1 Feedback 2
P10.35	PID1 Feedback 1 Min	-200.00	200.00	%	0.00	1333	
P10.36	PID1 Feedback 1 Max	-200.00	200.00	%	100.00	1334	
P10.37 ①②	PID1 Feedback 2 Source				0	1335	See Par ID 1332
P10.38	PID1 Feedback 2 Min	-200.00	200.00	%	0.00	1336	
P10.39	PID1 Feedback 2 Max	-200.00	200.00	%	100.00	1337	
P10.40 ①	PID1 Feedforward Func				0	1338	See Par ID 1330
P10.41	PID1 Feedforward Gain	-1000.0	1000.0	%	100.0	1339	
P10.42 ①②	PID1 Feedforward 1 Source				0	1340	0 = Not Used 1 = AI1 2 = AI2 3 = Slot A: AI1 4 = Slot B: AI1 5 = FB Process Data Input 1 6 = FB Process Data Input 2 7 = FB Process Data Input 3 8 = FB Process Data Input 4 9 = FB Process Data Input 5 10 = FB Process Data Input 6 11 = FB Process Data Input 7 12 = FB Process Data Input 8 13 = PT100 Temperature 14 = PID2 Output 15 = SlotA PT100 Temp Channel 1 16 = SlotA PT100 Temp Channel 2 17 = SlotA PT100 Temp Channel 3 18 = SlotB PT100 Temp Channel 1 19 = SlotB PT100 Temp Channel 2 20 = SlotB PT100 Temp Channel 3 21 = FB PID1 Feedforward 1 22 = FB PID1 Feedforward 2
P10.43	PID1 Feedforward 1 Min	-200.00	200.00	%	0.00	1341	
P10.44	PID1 Feedforward 1 Max	-200.00	200.00	%	100.00	1342	

- Notes:**
- ① Parameter value can only be changed after the drive has stopped.
  - ② Parameter value will be set to be default when changing macros.
  - ③ Input function is level sensed.
  - ④ Input function is edge sensed.
  - ⑤ Input function is edge sensed when using StartP/StopP start logic.

**Table 112. PID controller 1—P10, continued.**

Code	Parameter	Min.	Max.	Unit	Default	ID	Note
P10.45 ①②	PID1 Feedforward 2 Source				0	1343	See Par ID 1340
P10.46	PID1 Feedforward 2 Min	-200.00	200.00	%	0.00	1344	
P10.47	PID1 Feedforward 2 Max	-200.00	200.00	%	100.00	1345	
P10.48	PID1 Set Point 1 Comp Enable				0	1352	See Par ID 2462
P10.49	PID1 Set Point 1 Comp Max	-200.00	200.00	%	0.00	1353	
P10.50	PID1 Set Point 2 Comp Enable				0	1354	See Par ID 2462
P10.51	PID1 Set Point 2 Comp Max	-200.00	200.00	%	0.00	1355	
P10.52	PID1 Wake Up Action				0	2466	0 = Below Wake Up Level 1 = Above Wake Up Level 2 = Below Wake Up Level (PID ref.) 3 = Above Wake Up Level (PID ref.)
P10.53	FB PID1 Set Point 1	See Par ID 1298	See Par ID 1300	Varies		2542	
P10.54	FB PID1 Set Point 2	See Par ID 1298	See Par ID 1300	Varies		2544	
P10.55	FB PID1 Feedback 1			%		2550	
P10.56	FB PID1 Feedback 2			%		2551	
P10.57	FB PID1 Feedforward 1			%		2554	
P10.58	FB PID1 Feedforward 2			%		2555	
P10.59	PID1 Sleep Boost level	-9999	9999	Varies	0	2660	
P10.60	PID1 Sleep Boost Max Time	1	300	s	30	2661	
P10.61	PID1 Low Feedback Level	0.0	6000.0	Varies	0.0	2811	
P10.62	PID1 Low Feedback Time	0	3600	s	10	2812	
P10.63 ③	PID1 Low Feedback Protection				0	2813	See Par ID 307
P10.64	PID1 High Feedback Level	0.0	6000.0	Varies	150.0	2814	
P10.65	PID1 High Feedback Time	0	3600	s	5	2815	
P10.66 ④	PID1 High Feedback Protection				0	2816	See Par ID 307
P10.67 ⑤	PID1 Hysteresis Level	0.0	100.0	Varies	0.0	2817	
P10.68	PID1 Backup Feedback Source				0	2825	0 = Not Used 1 = AI1 2 = AI2 3 = Slot A: AI1 4 = Slot B: AI1

**Table 113. PID controller 2—P11.**

Code	Parameter	Min.	Max.	Unit	Default	ID	Note
P11.1	PID2 Control Gain	0.00	200.00	%	100.00	1356	
P11.2	PID2 Control I Time	0.00	600.00	s	1.00	1357	
P11.3	PID2 Control D Time	0.00	100.00	s	0.00	1358	
P11.4 ①	PID2 Process Unit				0	1359	See Par ID 1297
P11.5	PID2 Process Unit Min	-99999.99	See Par ID 1362	Varies	0.00	1360	

- Notes:**
- ① Parameter value can only be changed after the drive has stopped.
  - ② Parameter value will be set to be default when changing macros.
  - ③ Input function is level sensed.
  - ④ Input function is edge sensed.
  - ⑤ Input function is edge sensed when using StartP/StopP start logic.

## Chapter 7—Multi-PID application

**Table 113. PID controller 2—P11, continued.**

Code	Parameter	Min.	Max.	Unit	Default	ID	Note
P11.6	PID2 Process Unit Max	See Par ID 1360	99999.99	Varies	100.00	1362	
P11.7	PID2 Process Unit Decimal	0	4		2	1364	
P11.8 ①	PID2 Error Inversion				0	1365	See Par ID 181
P11.9	PID2 Dead Band	0.00	99999.99	Varies	0.00	1366	
P11.10	PID2 Dead Band Delay	0.00	320.00	s	0.00	1368	
P11.11	PID2 Keypad Set Point 1	See Par ID 1360	See Par ID 1362	Varies	0.00	1369	
P11.12	PID2 Keypad Set Point 2	See Par ID 1360	See Par ID 1362	Varies	0.00	1371	
P11.13	PID2 Ramp Time	0.00	300.00	s	0.00	1373	
P11.14 ①	PID2 Set Point 1 Source				1	1374	0 = Not Used 1 = PID2 Keypad Set Point 1 2 = PID2 Keypad Set Point 2 3 = AI1 4 = AI2 5 = Slot A: AI1 6 = Slot B: AI1 7 = FB Process Data Input 1 8 = FB Process Data Input 2 9 = FB Process Data Input 3 10 = FB Process Data Input 4 11 = FB Process Data Input 5 12 = FB Process Data Input 6 13 = FB Process Data Input 7 14 = FB Process Data Input 8 15 = PID1 Output 16 = Multi Drive Network 17 = FB PID2 Set Point 1 18 = FB PID2 Set Point 2
P11.15	PID2 Set Point 1 Min	-200.00	200.00	%	0.00	1375	
P11.16	PID2 Set Point 1 Max	-200.00	200.00	%	100.00	1376	
P11.17 ①	PID2 Set Point 1 Sleep Enable				0	1377	See Par ID 2462
P11.18 ①	PID2 Set Point 1 Sleep Unit Sel				0	2398	0 = Output Frequency 1 = Motor Speed 2 = Motor Current 3 = PID2 Feedback
P11.19	PID2 Set Point 1 Sleep Level			Varies	0.00	2454	
P11.20	PID2 Set Point 1 Sleep Delay	0	3000	s	0	1379	
P11.21	PID2 Set Point 1 WakeUp Level	-99999.99	99999.99	Varies	0.00	1380	
P11.22	PID2 Set Point 1 Boost	-2.0	2.0		1.0	1382	
P11.23 ①	PID2 Set Point 2 Source				2	1383	See Par ID 1374
P11.24	PID2 Set Point 2 Min	-200.00	200.00	%	0.00	1384	
P11.25	PID2 Set Point 2 Max	-200.00	200.00	%	100.00	1385	
P11.26 ①	PID2 Set Point 2 Sleep Enable				0	1386	See Par ID 2462
P11.27 ①	PID2 Set Point 2 Sleep Unit Sel				0	2399	See Par ID 2398
P11.28	PID2 Set Point 2 Sleep Level			Varies	0.00	2456	
P11.29	PID2 Set Point 2 Sleep Delay	0	3000	s	0	1388	

- Notes:**
- ① Parameter value can only be changed after the drive has stopped.
  - ② Parameter value will be set to be default when changing macros.
  - ③ Input function is level sensed.
  - ④ Input function is edge sensed.
  - ⑤ Input function is edge sensed when using StartP/StopP start logic.

**Table 113. PID controller 2—P11, continued.**

Code	Parameter	Min.	Max.	Unit	Default	ID	Note
P11.30	PID2 Set Point 2 WakeUp Level	-99999.99	99999.99	Varies	0.00	1389	
P11.31	PID2 Set Point 2 Boost	-2.0	2.0		1.0	1391	
P11.32 ④	PID2 Feedback Func				0	1392	See Par ID 1330
P11.33	PID2 Feedback Gain	-1000.0	1000.0	%	100.0	1393	
P11.34 ④	PID2 Feedback 1 Source				2	1394	0 = Not Used 1 = AI1 2 = AI2 3 = Slot A: AI1 4 = Slot B: AI1 5 = FB Process Data Input 1 6 = FB Process Data Input 2 7 = FB Process Data Input 3 8 = FB Process Data Input 4 9 = FB Process Data Input 5 10 = FB Process Data Input 6 11 = FB Process Data Input 7 12 = FB Process Data Input 8 13 = PT100 Temperature 14 = PID1 Output 15 = SlotA PT100 Temp Channel 1 16 = SlotA PT100 Temp Channel 2 17 = SlotA PT100 Temp Channel 3 18 = SlotB PT100 Temp Channel 1 19 = SlotB PT100 Temp Channel 2 20 = SlotB PT100 Temp Channel 3 21 = FB PID2 Feedback 1 22 = FB PID2 Feedback 2
P11.35	PID2 Feedback 1 Min	-200.00	200.00	%	0.00	1395	
P11.36	PID2 Feedback 1 Max	-200.00	200.00	%	100.00	1396	
P11.37 ④	PID2 Feedback 2 Source				0	1397	See Par ID 1394
P11.38	PID2 Feedback 2 Min	-200.00	200.00	%	0.00	1398	
P11.39	PID2 Feedback 2 Max	-200.00	200.00	%	100.00	1399	
P11.40 ④	PID2 Feedforward Func				0	1400	See Par ID 1330
P11.41	PID2 Feedforward Gain	-1000.0	1000.0	%	100.0	1401	
P11.42 ④	PID2 Feedforward 1 Source				0	1402	0 = Not Used 1 = AI1 2 = AI2 3 = Slot A: AI1 4 = Slot B: AI1 5 = FB Process Data Input 1 6 = FB Process Data Input 2 7 = FB Process Data Input 3 8 = FB Process Data Input 4 9 = FB Process Data Input 5 10 = FB Process Data Input 6 11 = FB Process Data Input 7 12 = FB Process Data Input 8 13 = PT100 Temperature 14 = PID1 Output 15 = SlotA PT100 Temp Channel 1

- Notes:**
- ① Parameter value can only be changed after the drive has stopped.
  - ② Parameter value will be set to be default when changing macros.
  - ③ Input function is level sensed.
  - ④ Input function is edge sensed.
  - ⑤ Input function is edge sensed when using StartP/StopP start logic.

## Chapter 7—Multi-PID application

**Table 113. PID controller 2—P11, continued.**

Code	Parameter	Min.	Max.	Unit	Default	ID	Note
P11.42 ④, continued	PID2 Feedforward 1 Source				0	1402	16 = SlotA PT100 Temp Channel 2 17 = SlotA PT100 Temp Channel 3 18 = SlotB PT100 Temp Channel 1 19 = SlotB PT100 Temp Channel 2 20 = SlotB PT100 Temp Channel 3 21 = FB PID2 Feedforward 1 22 = FB PID2 Feedforward 2
P11.43	PID2 Feedforward 1 Min	-200.00	200.00	%	0.00	1403	
P11.44	PID2 Feedforward 1 Max	-200.00	200.00	%	100.00	1404	
P11.45 ④	PID2 Feedforward 2 Source				0	1405	See Par ID 1402
P11.46	PID2 Feedforward 2 Min	-200.00	200.00	%	0.00	1406	
P11.47	PID2 Feedforward 2 Max	-200.00	200.00	%	100.00	1407	
P11.48	PID2 Set Point1 Comp Enable				0	1414	See Par ID 2462
P11.49	PID2 Set Point1 Comp Max	-200.00	200.00	%	0.00	1415	
P11.50	PID2 Set Point 2 Comp Enable				0	1416	See Par ID 2462
P11.51	PID2 Set Point 2 Comp Max	-200.00	200.00	%	0.00	1417	
P11.52	PID2 Wake Up Action				0	2467	See Par ID 2466
P11.53	FB PID2 Set Point 1	See Par ID 1298	See Par ID 1300	Varies		2546	
P11.54	FB PID2 Set Point 2	See Par ID 1298	See Par ID 1300	Varies		2548	
P11.55	FB PID2 Feedback 1			%		2552	
P11.56	FB PID2 Feedback 2			%		2553	
P11.57	FB PID2 Feedforward 1			%		2556	
P11.58	FB PID2 Feedforward 2			%		2557	
P11.59	PID2 Sleep Boost level	-9999	9999	Varies	0	2662	
P11.60	PID2 Sleep Boost Max Time	1	300	s	30	2663	
P11.61	PID2 Low Feedback Level	0.0	6000.0	Varies	0.0	2818	
P11.62	PID2 Low Feedback Time	0	3600	s	10	2819	
P11.63 ④	PID2 Low Feedback Protection				0	2820	See Par ID 307
P11.64	PID2 High Feedback Level	0.0	6000.0	Varies	150.0	2821	
P11.65	PID2 High Feedback Time	0	3600	s	5	2822	
P11.66 ④	PID2 High Feedback Protection				0	2823	See Par ID 307
P11.67 ④	PID2 Hysteresis Level	0.0	100.0	Varies	0.0	2824	
P11.68	PID2 Backup Feedback Source				0	2826	See Par ID 2825

- Notes:**
- ① Parameter value can only be changed after the drive has stopped.
  - ② Parameter value will be set to be default when changing macros.
  - ③ Input function is level sensed.
  - ④ Input function is edge sensed.
  - ⑤ Input function is edge sensed when using StartP/StopP start logic.



**Table 114. Preset speed—P12.**

Code	Parameter	Min.	Max.	Unit	Default	ID	Note
P12.1	Preset Speed 1	0.00	See Par ID 102	Hz	5.00	105	
P12.2	Preset Speed 2	0.00	See Par ID 102	Hz	10.00	106	
P12.3	Preset Speed 3	0.00	See Par ID 102	Hz	15.00	118	
P12.4	Preset Speed 4	0.00	See Par ID 102	Hz	20.00	119	
P12.5	Preset Speed 5	0.00	See Par ID 102	Hz	25.00	120	
P12.6	Preset Speed 6	0.00	See Par ID 102	Hz	30.00	121	
P12.7	Preset Speed 7	0.00	See Par ID 102	Hz	35.00	122	

**Table 115. Brake—P14.**

Code	Parameter	Min.	Max.	Unit	Default	ID	Note
P14.1 ①	DC-Brake Current	Drive NomCurrCT*15/100	Drive NomCurrCT*15/10	A	DriveNomCurrCT*1/2	254	
P14.2 ①	Start DC-Brake Time	0.00	600.00	s	0.00	263	
P14.3 ①	Stop DC-Brake Frequency	0.10	10.00	Hz	1.50	262	
P14.4 ①	Stop DC-Brake Time	0.00	600.00	s	0.00	255	
P14.5 ①	Brake Chopper Mode				0	251	0 = Disabled 1 = B(Run) T(Rdy) 2 = External 3 = B(Rdy) T(Rdy) 4 = B(Run) T(No)
P14.6 ①	Flux Brake				0	266	0 = Off 1 = On
P14.7 ①	Flux Brake Current	ActiveMotor NomCurr*1/10	See Par ID 107	A	ActiveMotorNomCurr*1/2	265	

**Table 116. Fire mode—P15.**

Code	Parameter	Min.	Max.	Unit	Default	ID	Note
P15.1 ①	Fire Mode Function				0	535	0 = Closing Contact 1 = Opening Contact
P15.2 ①②	Fire Mode Ref Select Function				0	536	0 = Fire Mode Min Frequency 1 = Fire Mode Ref 2 = Fieldbus Ref 3 = AI1 4 = AI2 5 = AI1 + AI2 6 = PID1 Control Output 7 = PID2 Control Output
P15.3	Fire Mode Frequency	See Par ID 101	See Par ID 102	Hz	MotorNomFreqMFG	537	
P15.4	Fire Mode % Speed Ref 1	0.0	100.0	%	75.0	565	
P15.5	Fire Mode % Speed Ref 2	0.0	100.0	%	100.0	564	
P15.6 ①	Smoke Purge Frequency	0.0	100.0	%	50.0	554	
P15.7	Fire Mode Test Enable					2443	See Par ID 2462

- Notes:**
- ① Parameter value can only be changed after the drive has stopped.
  - ② Parameter value will be set to be default when changing macros.
  - ③ Input function is level sensed.
  - ④ Input function is edge sensed.
  - ⑤ Input function is edge sensed when using StartP/StopP start logic.

**Table 117. Second motor parameter—P16.**

Code	Parameter	Min.	Max.	Unit	Default	ID	Note
P16.1 ①	Motor Nom Current 2	DriveNomCurrCT*1/10	DriveNomCurrCT*2	A	DriveNomCurrCT	577	
P16.2 ①	Motor Nom Speed 2	300	20000	rpm	SecdMotorNomSpeedMFG	578	
P16.3 ①	Motor PF 2	0.30	1.00		0.85	579	
P16.4 ①	Motor Nom Volt 2	180	690	V	SecdMotorNomVoltMFG	580	
P16.5 ①	Motor Nom Freq 2	8.00	400.00	Hz	SecdMotorNomFreqMFG	581	
P16.6 ①	Stator Resistor 2	0.001	65.535	ohm	0.033	1419	

## Bypass

**Table 118. Basic setting—P17.1.**

Code	Parameter	Min.	Max.	Unit	Default	ID	Note
P17.1.1 ①	Bypass Enable				0	1418	See Par ID 2462
P17.1.2 ①	Bypass Start Delay	1	32765	s	5	544	
P17.1.3 ①	Auto Bypass				0	542	See Par ID 2462
P17.1.4 ①	Auto Bypass Delay	0	32765	s	10	543	
P17.1.5 ①	OverCurrent Bypass Enable				0	547	See Par ID 2462
P17.1.6 ①	IGBT Fault Bypass Enable				0	546	See Par ID 2462
P17.1.7 ①	4mA Fault Bypass Enable				0	548	See Par ID 2462
P17.1.8 ①	UnderVoltage Bypass Enable				0	545	See Par ID 2462
P17.1.9 ①	OverVoltage Bypass Enable				0	549	See Par ID 2462
P17.1.10 ①	Motor OverTemp Bypass Enable				0	1698	See Par ID 2462
P17.1.11 ①	UnderLoad Bypass Enable				0	1699	See Par ID 2462
P17.1.12 ①	External Bypass Enable				0	1700	See Par ID 2462
P17.1.13 ①	Charge Switch Fault Bypass Enable				0	1701	See Par ID 2462
P17.1.14 ①	Saturation Trip Fault Bypass Enable				0	1702	See Par ID 2462
P17.1.15 ①	Under Temp Fault Bypass Enable				0	1703	See Par ID 2462
P17.1.16 ①	EEPROM Fault Bypass Enable				0	1704	See Par ID 2462
P17.1.17 ①	Control board EEPROM Fault Bypass Enable				0	1705	See Par ID 2462
P17.1.18 ①	Watchdog Fault Bypass Enable				0	1706	See Par ID 2462
P17.1.19 ①	Fan Cooling Fault Bypass Enable				0	1707	See Par ID 2462
P17.1.20 ①	Keypad Com Fault Bypass Enable				0	1708	See Par ID 2462
P17.1.21 ①	Option Card Fault Bypass Enable				0	1709	See Par ID 2462
P17.1.22 ①	RTC Clock Fault Bypass Enable				0	1710	See Par ID 2462
P17.1.23 ①	Ctrl Board OverTemp Fault Bypass Enable				0	1711	See Par ID 2462

- Notes:**
- ① Parameter value can only be changed after the drive has stopped.
  - ② Parameter value will be set to be default when changing macros.
  - ③ Input function is level sensed.
  - ④ Input function is edge sensed.
  - ⑤ Input function is edge sensed when using StartP/StopP start logic.

**Table 118. Basic setting—P17.1, continued.**

Code	Parameter	Min.	Max.	Unit	Default	ID	Note
P17.1.24 ①	Fieldbus Fault Bypass Enable				0	1713	See Par ID 2462
P17.1.25 ①	Op Cont Interlock Fault Bypass Enable				0	2832	See Par ID 2462

**Table 119. Redundant drive—P17.2.**

Code	Parameter	Min.	Max.	Unit	Default	ID	Note
P17.2.1	Redundant Drive Enable				0	2476	See Par ID 2462
P17.2.2 ①	Drive ID	0	5		0	2278	
P17.2.3	Redundant Run Time Enable				0	2477	See Par ID 2462
P17.2.4	Redundant Run Time Reset					2478	See Par ID 2125
P17.2.5	Redundant RunTime Limit	0.00	30000.00	h	0.00	2479	

## Pump parameters

**Table 120. Basic setting—P18.1.**

Code	Parameter	Min.	Max.	Unit	Default	ID	Note
P18.1.1 ①	Multi-pump Mode				0	2279	0 = Disabled 1 = Single Drive Control 2 = Multi Drive Network
P18.1.2 ①	Drive ID	0	5		0	2278	
P18.1.3	PID Bandwidth	0.00	6000.00	Varies	10.00	2458	
P18.1.4 ①	Staging Frequency	See Par ID 101	400.00		50.00	2315	
P18.1.5 ①	De-Staging Frequency	0.00	See Par ID 102		0.00	2316	
P18.1.6	Add/Remove Delay	0	3600	s	10	344	
P18.1.7	Interlock Enable				0	350	See Par ID 2462
P18.1.8 ①	Damper Start				0	483	0 = Normal 1 = Interlock Start 2 = Interlock Tout 3 = Interlock Delay
P18.1.9 ①	Damper Time Out	1	32500	s	5	484	
P18.1.10 ①	Damper Delay	1	32500	s	5	485	
P18.1.11	Derag Cycles	0	10		3	2468	
P18.1.12	Derag at Start/Stop				0	2469	0 = Off 1 = Start 2 = Stop 3 = Start and Stop 4 = Digital Input
P18.1.13	Deragging Run Time	0	3600	s	0	2470	
P18.1.14	Derag Speed	See Par ID 101	See Par ID 102	Hz	5.00	2471	
P18.1.15	Derag Off Delay	1	600	s	10	2472	
P18.1.16 ①	Multi-pump Mode 2				0	2659	See Par ID 2279

- Notes:**
- ① Parameter value can only be changed after the drive has stopped.
  - ② Parameter value will be set to be default when changing macros.
  - ③ Input function is level sensed.
  - ④ Input function is edge sensed.
  - ⑤ Input function is edge sensed when using StartP/StopP start logic.

## Multi-pump status

**Table 121. Operation mode—P18.2.1.**

Code	Parameter	Min.	Max.	Unit	Default	ID	Note
P18.2.1.1	MPC Drive1 Operate Mode					2218	0 = Offline 1 = Slave Drive 2 = Master Drive 3 = Redundant Drive
P18.2.1.2	MPC Drive2 Operate Mode					2230	See Par ID 2218
P18.2.1.3	MPC Drive3 Operate Mode					2242	See Par ID 2218
P18.2.1.4	MPC Drive4 Operate Mode					2254	See Par ID 2218
P18.2.1.5	MPC Drive5 Operate Mode					2266	See Par ID 2218

**Table 122. Multi-pump status—P18.2.2.**

Code	Parameter	Min.	Max.	Unit	Default	ID	Note
P18.2.2.1	MPC Drive1 Status				5	2219	0 = Stopped 1 = Sleep 2 = Regulating 3 = Wait for CMD 4 = Following 5 = Unknown 6 = Master Local Control 7 = Slave Local Control
P18.2.2.2	MPC Drive2 Status				5	2231	See Par ID 2219
P18.2.2.3	MPC Drive3 Status				5	2243	See Par ID 2219
P18.2.2.4	MPC Drive4 Status				5	2255	See Par ID 2219
P18.2.2.5	MPC Drive5 Status				5	2267	See Par ID 2219

**Table 123. Network status—P18.2.3.**

Code	Parameter	Min.	Max.	Unit	Default	ID	Note
P18.2.3.1	MPC Drive1 NetworkStatus					2220	0 = Disconnected 1 = Fault 2 = Local Control 3 = Pump Lost 4 = Need Alternation 5 = No Error
P18.2.3.2	MPC Drive2 NetworkStatus					2232	See Par ID 2220
P18.2.3.3	MPC Drive3 NetworkStatus					2244	See Par ID 2220
P18.2.3.4	MPC Drive4 NetworkStatus					2256	See Par ID 2220
P18.2.3.5	MPC Drive5 NetworkStatus					2268	See Par ID 2220

- Notes:**
- ① Parameter value can only be changed after the drive has stopped.
  - ② Parameter value will be set to be default when changing macros.
  - ③ Input function is level sensed.
  - ④ Input function is edge sensed.
  - ⑤ Input function is edge sensed when using StartP/StopP start logic.

## Multi-pump measurement

**Table 124. Latest fault code—P18.3.1.**

Code	Parameter	Min.	Max.	Unit	Default	ID	Note
P18.3.1.1	MPC Drive1 Last Fault Code					2221	
P18.3.1.2	MPC Drive2 Last Fault Code					2233	
P18.3.1.3	MPC Drive3 Last Fault Code					2245	
P18.3.1.4	MPC Drive4 Last Fault Code					2257	
P18.3.1.5	MPC Drive5 Last Fault Code					2269	

**Table 125. Output frequency—P18.3.2.**

Code	Parameter	Min.	Max.	Unit	Default	ID	Note
P18.3.2.1	MPC Drive1 f-Out			Hz		2222	
P18.3.2.2	MPC Drive2 f-Out			Hz		2234	
P18.3.2.3	MPC Drive3 f-Out			Hz		2246	
P18.3.2.4	MPC Drive4 f-Out			Hz		2258	
P18.3.2.5	MPC Drive5 f-Out			Hz		2270	

**Table 126. Motor voltage—P18.3.3.**

Code	Parameter	Min.	Max.	Unit	Default	ID	Note
P18.3.3.1	MPC Drive1 V-Out			V		2223	
P18.3.3.2	MPC Drive2 V-Out			V		2235	
P18.3.3.3	MPC Drive3 V-Out			V		2247	
P18.3.3.4	MPC Drive4 V-Out			V		2259	
P18.3.3.5	MPC Drive5 V-Out			V		2271	

**Table 127. Motor current—P18.3.4.**

Code	Parameter	Min.	Max.	Unit	Default	ID	Note
P18.3.4.1	MPC Drive1 I-Out			A		2224	
P18.3.4.2	MPC Drive2 I-Out			A		2236	
P18.3.4.3	MPC Drive3 I-Out			A		2248	
P18.3.4.4	MPC Drive4 I-Out			A		2260	
P18.3.4.5	MPC Drive5 I-Out			A		2272	

**Table 128. Motor torque—P18.3.5.**

Code	Parameter	Min.	Max.	Unit	Default	ID	Note
P18.3.5.1	MPC Drive1 M-Out			%		2225	
P18.3.5.2	MPC Drive2 M-Out			%		2237	
P18.3.5.3	MPC Drive3 M-Out			%		2249	
P18.3.5.4	MPC Drive4 M-Out			%		2261	
P18.3.5.5	MPC Drive5 M-Out			%		2273	

- Notes:**
- ① Parameter value can only be changed after the drive has stopped.
  - ② Parameter value will be set to be default when changing macros.
  - ③ Input function is level sensed.
  - ④ Input function is edge sensed.
  - ⑤ Input function is edge sensed when using StartP/StopP start logic.

## Chapter 7—Multi-PID application

**Table 129. Motor power—P18.3.6.**

Code	Parameter	Min.	Max.	Unit	Default	ID	Note
P18.3.6.1	MPC Drive1 P-Out			%		2226	
P18.3.6.2	MPC Drive2 P-Out			%		2238	
P18.3.6.3	MPC Drive3 P-Out			%		2250	
P18.3.6.4	MPC Drive4 P-Out			%		2262	
P18.3.6.5	MPC Drive5 P-Out			%		2274	

**Table 130. Motor speed—P18.3.7.**

Code	Parameter	Min.	Max.	Unit	Default	ID	Note
P18.3.7.1	MPC Drive1 n-Out			rpm		2227	
P18.3.7.2	MPC Drive2 n-Out			rpm		2239	
P18.3.7.3	MPC Drive3 n-Out			rpm		2251	
P18.3.7.4	MPC Drive4 n-Out			rpm		2263	
P18.3.7.5	MPC Drive5 n-Out			rpm		2275	

**Table 131. Run time—P18.3.8.**

Code	Parameter	Min.	Max.	Unit	Default	ID	Note
P18.3.8.1	MPC Drive1 t-Run			h		2228	
P18.3.8.2	MPC Drive2 t-Run			h		2240	
P18.3.8.3	MPC Drive3 t-Run			h		2252	
P18.3.8.4	MPC Drive4 t-Run			h		2264	
P18.3.8.5	MPC Drive5 t-Run			h		2276	

**Table 132. Multi-pump single drive—P18.4.**

Code	Parameter	Min.	Max.	Unit	Default	ID	Note
P18.4.1 ①	Number of Pumps	1	5		1	342	
P18.4.2	Include Freq Converter				1	346	See Par ID 2462
P18.4.3	Auto-Change Enable				0	345	See Par ID 2462
P18.4.4	Auto-Change Interval	0.0	3000.0	h	48.0	347	
P18.4.5	Auto-Change Freq Limit	See Par ID 101	See Par ID 102	Hz	25.00	349	
P18.4.6	Auto-Change Pump Limit	0	5		1	348	
P18.4.7 ①	Pipe Fill Aux Pump Select				0	2439	0 = Disabled 1 = Aux Motor 1 2 = Aux Motor 2 3 = Aux Motor 3 4 = Aux Motor 4
P18.4.8 ①	Pipe Fill Aux Pump Run Time	0.0	3600.0	min	0.0	2440	
P18.4.9 ①	Pipe Fill Aux Pump Operation				0	2441	0 = Automatic 1 = Stop
P18.4.10 ①	Pipe Fill Aux Pump Delay	0.0	600.0	min	2.0	2442	

- Notes:**
- ① Parameter value can only be changed after the drive has stopped.
  - ② Parameter value will be set to be default when changing macros.
  - ③ Input function is level sensed.
  - ④ Input function is edge sensed.
  - ⑤ Input function is edge sensed when using StartP/StopP start logic.

**Table 133. Multi-pump multi-drive—P18.5.**

Code	Parameter	Min.	Max.	Unit	Default	ID	Note
P18.5.1 ①	Number of Drives	1	5		1	2449	
P18.5.2 ①	Regulation Source				0	2284	0 = Network Only 1 = PID Controller 1
P18.5.3 ①	Recovery Method				0	2285	See Par ID 2441
P18.5.4 ①	Callback Source				0	2286	0 = No Action 1 = Safety Torque Off
P18.5.5	Add/Remove Drive Selection				0	2311	0 = Drive ID 1 = Run Time
P18.5.6	Run Time Enable				0	2280	See Par ID 2462
P18.5.7	Run Time Limit	0.0	300000.0	h	0.0	2281	
P18.5.8	Run Time Reset				0	2283	0 = No Action 1 = Reset
P18.5.9	Master Drive Mode				0	2473	0 = Follow PID 1 = Fixed Speed 2 = Turn Off
P18.5.10	Master Fixed Speed	See Par ID 101	See Par ID 102	Hz	50.00	2474	
P18.5.11	Master Fixed Speed Delay	0	1000	s	5	2475	

**Table 134. Protections—P18.6.**

Code	Parameter	Min.	Max.	Unit	Default	ID	Note
P18.6.1 ①	Pipe Fill Loss Detection Method				0	2406	0 = Motor Current 1 = Motor Power 2 = Motor Torque
P18.6.2	Pipe Fill Loss Level	0.0	1000.0	Varies	0.0	2407	
P18.6.3	Pipe Fill Loss Time	0	600	s	0	2408	
P18.6.4 ①	Pipe Fill Loss Frequency	0.00	See Par ID 102	Hz	0.00	2409	
P18.6.5 ①	Pipe Fill Loss Response				0	2410	See Par ID 2427
P18.6.6	Pipe Fill Loss Attempts	0	10		1	2411	
P18.6.7	Prime Pump Enable				0	2428	See Par ID 190
P18.6.8	Prime Pump Level	0.00	6000.00	Varies	0.00	2429	
P18.6.9	Prime Pump Frequency	See Par ID 101	See Par ID 102	Hz	0.00	2431	
P18.6.10	Prime Pump Delay Time	0.0	3600.0	min	0.0	2432	
P18.6.11	Prime Pump Loss of Prime Level	0.0	1000.0	Varies	0.0	2433	
P18.6.12	Prime Pump Level 2	0.00	6000.00	Varies	0.00	2434	
P18.6.13	Prime Pump Frequency 2	See Par ID 101	See Par ID 102	Hz	0.00	2436	
P18.6.14	Prime Pump Delay Time 2	0.0	3600.0	min	0.0	2437	
P18.6.15	Prime Pump Loss of Prime Level 2	0.0	1000.0	Varies	0.0	2438	
P18.6.16 ①	Broken Pipe Fault Response				0	1853	See Par ID 307
P18.6.17	Broken Pipe Level	0.0	6000.0	Varies	15.0	1854	
P18.6.18	Broken Pipe Delay	1.0	120.0	s	15.0	1855	
P18.6.19	Broken Pipe Frequency	1.00	See Par ID 102	Hz	25.00	1856	
P18.6.20	Jockey Pump Enable				0	2804	0 = Not Used 1 = PID Sleep 2 = PID Sleep(Level)
P18.6.21	Jockey Start Level	-99999.99	See Par ID 2807	Varies	0.00	2805	

- Notes:**
- ① Parameter value can only be changed after the drive has stopped.
  - ② Parameter value will be set to be default when changing macros.
  - ③ Input function is level sensed.
  - ④ Input function is edge sensed.
  - ⑤ Input function is edge sensed when using StartP/StopP start logic.

## Chapter 7—Multi-PID application

**Table 134. Protections—P18.6, continued.**

Code	Parameter	Min.	Max.	Unit	Default	ID	Note
P18.6.22	Jockey Stop Level	See Par ID 2805	99999.99	Varies	0.00	2807	
P18.6.23	Lube Pump Enable				0	2809	See Par ID 2462
P18.6.24	Lube Pump Time	0.0	300.0	s	0.0	2810	

**Table 135. Real time clock—P19.**

Code	Parameter	Min.	Max.	Unit	Default	ID	Note
P19.1	Interval 1 On Time				0,0,0	491	
P19.2	Interval 1 Off Time				0,0,0	493	
P19.3	Interval 1 From Day				0	517	0 = Sunday 1 = Monday 2 = Tuesday 3 = Wednesday 4 = Thursday 5 = Friday 6 = Saturday
P19.4	Interval 1 To Day				0	518	See Par ID 517
P19.5	Interval 1 Channel				0	519	0 = Not Used 1 = Time Channel 1 2 = Time Channel 2 3 = Time Channel 3
P19.6	Interval 2 On Time				0,0,0	495	
P19.7	Interval 2 Off Time				0,0,0	497	
P19.8	Interval 2 From Day				0	520	See Par ID 517
P19.9	Interval 2 To Day				0	521	See Par ID 517
P19.10	Interval 2 Channel				0	522	See Par ID 519
P19.11	Interval 3 On Time				0,0,0	499	
P19.12	Interval 3 Off Time				0,0,0	501	
P19.13	Interval 3 From Day				0	523	See Par ID 517
P19.14	Interval 3 To Day				0	524	See Par ID 517
P19.15	Interval 3 Channel				0	525	See Par ID 519
P19.16	Interval 4 On Time				0,0,0	503	
P19.17	Interval 4 Off Time				0,0,0	505	
P19.18	Interval 4 From Day				0	526	See Par ID 517
P19.19	Interval 4 To Day				0	527	See Par ID 517
P19.20	Interval 4 Channel				0	528	See Par ID 519
P19.21	Interval 5 On Time				0,0,0	507	
P19.22	Interval 5 Off Time				0,0,0	509	
P19.23	Interval 5 From Day				0	529	See Par ID 517
P19.24	Interval 5 To Day				0	530	See Par ID 517
P19.25	Interval 5 Channel				0	531	See Par ID 519
P19.26	Timer 1 Duration	0	72000	s	0	511	
P19.27	Timer 1 Channel				0	532	See Par ID 519
P19.28	Timer 2 Duration	0	72000	s	0	513	
P19.29	Timer 2 Channel				0	533	See Par ID 519
P19.30	Timer 3 Duration	0	72000	s	0	515	
P19.31	Timer 3 Channel				0	534	See Par ID 519
P19.32	Interval 1 Setting				0	2487	0 = Weekly 1 = Daily
P19.33	Interval 2 Setting				0	2488	See Par ID 2487
P19.34	Interval 3 Setting				0	2489	See Par ID 2487

- Notes:**
- ① Parameter value can only be changed after the drive has stopped.
  - ② Parameter value will be set to be default when changing macros.
  - ③ Input function is level sensed.
  - ④ Input function is edge sensed.
  - ⑤ Input function is edge sensed when using StartP/StopP start logic.



**Table 135. Real time clock—P19, continued.**

Code	Parameter	Min.	Max.	Unit	Default	ID	Note
P19.35	Interval 4 Setting				0	2490	See Par ID 2487
P19.36	Interval 5 Setting				0	2491	See Par ID 2487

## Communication

**Table 136. FB process data input Sel—P20.1.**

Code	Parameter	Min.	Max.	Unit	Default	ID	Note
P20.1.1	FB Process Data Input 1 Sel	0	3000		2541	2533	
P20.1.2	FB Process Data Input 2 Sel	0	See Par ID 2533		2542	2534	
P20.1.3	FB Process Data Input 3 Sel	0	See Par ID 2533		2550	2535	
P20.1.4	FB Process Data Input 4 Sel	0	See Par ID 2533		0	2536	
P20.1.5	FB Process Data Input 5 Sel	0	See Par ID 2533		0	2537	
P20.1.6	FB Process Data Input 6 Sel	0	See Par ID 2533		0	2538	
P20.1.7	FB Process Data Input 7 Sel	0	See Par ID 2533		0	2539	
P20.1.8	FB Process Data Input 8 Sel	0	See Par ID 2533		0	2540	

**Table 137. FB process data output Sel—P20.2.**

Code	Parameter	Min.	Max.	Unit	Default	ID	Note
P20.2.1	FB Process Data Output 1 Sel				1	1556	
P20.2.2	FB Process Data Output 2 Sel				2	1557	
P20.2.3	FB Process Data Output 3 Sel				3	1558	
P20.2.4	FB Process Data Output 4 Sel				4	1559	
P20.2.5	FB Process Data Output 5 Sel				5	1560	
P20.2.6	FB Process Data Output 6 Sel				6	1561	
P20.2.7	FB Process Data Output 7 Sel				7	1562	
P20.2.8	FB Process Data Output 8 Sel				28	1563	

- Notes:**
- ① Parameter value can only be changed after the drive has stopped.
  - ② Parameter value will be set to be default when changing macros.
  - ③ Input function is level sensed.
  - ④ Input function is edge sensed.
  - ⑤ Input function is edge sensed when using StartP/StopP start logic.

**Table 137. FB process data output Sel—P20.2, continued.**

Code	Parameter	Min.	Max.	Unit	Default	ID	Note
P20.2.9 ②	Standard Status Word Bit0 Function Select				1	2415	0 = Not Used 1 = Ready 2 = Run 3 = Fault 4 = Fault Invert 5 = Warning 6 = Reversed 7 = At Speed 8 = Zero Frequency 9 = Freq Limit 1 Superv 10 = Freq Limit 2 Superv 11 = PID1 Superv 12 = PID2 Superv 13 = OverHeat Fault 14 = OverCurrent Regular 15 = OverVoltage Regular 16 = UnderVoltage Regular 17 = 4mA Ref Fault/Warning 20 = Torq Limit Superv 21 = Ref Limit Superv 22 = Control from I/O 23 = Un-Requested Rotation Direction 24 = Thermistor Fault Output 25 = Fire Mode 26 = In Bypass Mode 27 = Ext Fault/Warning 28 = Remote Control 29 = Jog Speed Select 30 = Motor Therm Protection 31 = FB Digital Input 1 32 = FB Digital Input 2 33 = FB Digital Input 3 34 = FB Digital Input 4 35 = Damper Control 36 = TC1 Status 37 = TC2 Status 38 = TC3 Status 39 = In E-Stop 40 = Power Limit Superv 41 = Temp Limit Superv 42 = Analog Input Superv 43 = Motor 1 Control 44 = Motor 2 Control 45 = Motor 3 Control 46 = Motor 4 Control 47 = Motor 5 Control 49 = PID1 Sleep 50 = PID2 Sleep 51 = Motor Current 1 Supv 52 = Motor Current 2 Supv 53 = Second AI Limit Supv 54 = DC Charge Switch Close 55 = Preheat Active 56 = Cold Weather Active 57 = Prime Pump Active 58 = 2th Stage Ramp Frequency Active 59 = STO Fault Output 60 = Run Bypass/Drive 61 = Bypass Overload 62 = Bypass Run 63 = Auto Local On COM Fault 64 = FieldBus RTU Fault 65 = FieldBus TCP Fault

- Notes:**
- ① Parameter value can only be changed after the drive has stopped.
  - ② Parameter value will be set to be default when changing macros.
  - ③ Input function is level sensed.
  - ④ Input function is edge sensed.
  - ⑤ Input function is edge sensed when using StartP/StopP start logic.

**Table 137. FB process data output Sel—P20.2, continued.**

Code	Parameter	Min.	Max.	Unit	Default	ID	Note
P20.2.9 ②, continued	Standard Status Word Bit0 Function Select				1	2415	66 = FieldBus MSTP Fault 67 = FieldBus EIP Fault 68 = FieldBus SlotA Fault 69 = FieldBus SlotB Fault 70 = FieldBus SWD Fault 71 = Jockey Pump Active 72 = Lube Pump Active 73 = PID1 Low Feedback 74 = PID1 High Feedback 75 = PID2 Low Feedback 76 = PID2 High Feedback 77 = Master in MPFC 78 = CP Interlock Fault
P20.2.10 ②	Standard Status Word Bit1 Function Select				2	2416	See Par ID 2415
P20.2.11 ②	Standard Status Word Bit2 Function Select				3	2417	See Par ID 2415
P20.2.12 ②	Standard Status Word Bit3 Function Select				4	2418	See Par ID 2415
P20.2.13 ②	Standard Status Word Bit4 Function Select				5	2419	See Par ID 2415
P20.2.14 ②	Standard Status Word Bit5 Function Select				6	2420	See Par ID 2415
P20.2.15 ②	Standard Status Word Bit6 Function Select				7	2421	See Par ID 2415
P20.2.16 ②	Standard Status Word Bit7 Function Select				8	2422	See Par ID 2415

- Notes:**
- ① Parameter value can only be changed after the drive has stopped.
  - ② Parameter value will be set to be default when changing macros.
  - ③ Input function is level sensed.
  - ④ Input function is edge sensed.
  - ⑤ Input function is edge sensed when using StartP/StopP start logic.

## RS-485 bus

**Table 138. Basic setting—P20.3.1.**

Code	Parameter	Min.	Max.	Unit	Default	ID	Note
P20.3.1.1 ①	RS485 Comm Set				0	586	0 = Modbus RTU 1 = BACnet MS/TP 2 = SWD

**Table 139. Modbus RTU—P20.3.2.**

Code	Parameter	Min.	Max.	Unit	Default	ID	Note
P20.3.2.1 ①	Slave Address	1	247		1	587	
P20.3.2.2 ①	Baud Rate				1	584	0 = 9600 1 = 19200 2 = 38400 3 = 57600 4 = 115200
P20.3.2.3 ①	Parity Type And Stop Bit				2	585	0 = None and 2 stop bits 1 = Odd and 1 stop bit 2 = Even and 1 stop bit 3 = None and 1 stop bit
P20.3.2.4	Modbus RTU Protocol Status					588	0 = Initial 1 = Stopped 2 = Operational 3 = Faulted
P20.3.2.5	Comm Timeout Modbus RTU	0	60000	ms	10000	593	
P20.3.2.6	Modbus RTU Fault Response				0	2516	0 = in Fieldbus Control 1 = in all Control

**Table 140. BACnet MS/TP—P20.3.3.**

Code	Parameter	Min.	Max.	Unit	Default	ID	Note
P20.3.3.1	MSTP Baud Rate				2	594	0 = 9600 1 = 19200 2 = 38400 3 = 76800 4 = 115200
P20.3.3.2	MSTP Device Address	0	127		1	595	
P20.3.3.3	MSTP Instance Number	0	4194302		0	596	
P20.3.3.4	MSTP Comm Timeout	0	60000	ms	10000	598	
P20.3.3.5	MSTP Protocol Status				0	599	0 = Stopped 1 = Operational 2 = Faulted
P20.3.3.6	MSTP Fault Code				0	600	0 = None 1 = Sole Master 2 = Duplicate MAC ID 3 = Baud rate fault
P20.3.3.7	MSTP Fault Response				0	2526	See Par ID 2516
P20.3.3.8 ①	MSTP Max Master	1	127		127	1537	

- Notes:**
- ① Parameter value can only be changed after the drive has stopped.
  - ② Parameter value will be set to be default when changing macros.
  - ③ Input function is level sensed.
  - ④ Input function is edge sensed.
  - ⑤ Input function is edge sensed when using StartP/StopP start logic.

**Table 141. Terminal: SWD—P20.3.4.**

Code	Parameter	Min.	Max.	Unit	Default	ID	Note
P20.3.4.1	Parameter Access				1	2630	0 = Local Control 1 = Fieldbus
P20.3.4.2 ①	Process Data Access				4	2631	0 = Local Control 1 = Fieldbus 2 = Mixed Interface 4 = NET, Local on Fault 5 = Dual Mode
P20.3.4.3	Fault Situation Counter					2632	
P20.3.4.4	Board Status					2609	
P20.3.4.5	Firmware Version					2610	
P20.3.4.6	Protocol Status					2612	0 = Not Configured 1 = Operational 2 = Diagnostics
P20.3.4.7	Operation Mode					2613	0 = PD2x16Bit Profil 1 = 8Bit Profil 2 = 1-0-A Switch
P20.3.4.8	PDP-Telegram Selection				1	2614	1= Standard Telegram
P20.3.4.9	Fault Counter PDP				0	2615	
P20.3.4.10	Fault Situations Max				8,8	2616	
P20.3.4.11	PDP-Profil Number				809	2618	
P20.3.4.12	PDP-Control Word					2619	
P20.3.4.13	PDP-Status Word				64	2620	
P20.3.4.14	PDP-MaxBlockLength				30	2621	
P20.3.4.15	PDP-NoOfMultiparameter				1	2622	
P20.3.4.16	PDP-MaxLatency				2	2623	
P20.3.4.17	PDP-DO Manufacturer					2624	
P20.3.4.18	PDP-DO Device Type					1451	
P20.3.4.19	PDP-DO FW-Interface					2625	
P20.3.4.20	PDP-DO FW-Year					2626	
P20.3.4.21	PDP-DO FW-DayMonth					2627	
P20.3.4.22	PDP-DO NoOfDOs				1	2628	
P20.3.4.23	PDP-DO Subclass				1	2629	

**Table 142. EtherNet/IP—P20.4**

Code	Parameter	Min.	Max.	Unit	Default	ID	Note
P20.4.1 ①	IP Address Mode				0	1500	0 = Static IP 1 = DHCP with AutoIP
P20.4.2	Active IP Address					1507	
P20.4.3	Active Subnet Mask					1509	
P20.4.4	Active Default Gateway					1511	
P20.4.5	MAC Address					1513	
P20.4.6 ①	Static IP Address				192.168.1.254	1501	
P20.4.7 ①	Static Subnet Mask				255.255.255.0	1503	
P20.4.8 ①	Static Default Gateway				192.168.1.1	1505	
P20.4.9	Ethernet IP Protocol Status					608	0 = Off 1 = Operational 2 = Faulted
P20.4.10	EIP Fault Response				0	2518	See Par ID 2516

- Notes:**
- ① Parameter value can only be changed after the drive has stopped.
  - ② Parameter value will be set to be default when changing macros.
  - ③ Input function is level sensed.
  - ④ Input function is edge sensed.
  - ⑤ Input function is edge sensed when using StartP/StopP start logic.

## Chapter 7—Multi-PID application

**Table 143. Modbus TCP—P20.5.**

Code	Parameter	Min.	Max.	Unit	Default	ID	Note
P20.5.1	Connection Limit				5	609	
P20.5.2	Modbus TCP Unit ID				1	610	
P20.5.3	Comm Timeout Modbus TCP	0	60000	ms	10000	611	
P20.5.4	Modbus TCP Protocol Status					612	See Par ID 599
P20.5.5	Modbus TCP Fault Response				0	2517	See Par ID 2516
P20.5.6	Modbus TCP Trusted IP Enable				0	74	See Par ID 2462
P20.5.7	Trusted IP White List				0xC0.0xA8.0x01.0xFF. 0x00.0x00.0x00.0x00. 0x00.0x00.0x00.0x00	68	

**Table 144. WebUI—P20.6.**

Code	Parameter	Min.	Max.	Unit	Default	ID	Note
P20.6.1	WebUI Protocol Status					2915	
P20.6.2	WebUI Fault Response				0	2916	See Par ID 2516
P20.6.3	WebUI Communication Timeout	30000	60000	ms	60000	2919	
P20.6.4 ①	WebUI Enable				1	2921	See Par ID 2462

## System

**Table 145. Basic setting—P21.1.**

Code	Parameter	Min.	Max.	Unit	Default	ID	Note
P21.1.1	Language				0	340	0 = English 1 = 中文 2 = Deutsch
P21.1.2 ①	Application					142	0 = Standard 1 = Multi-Pump 2 = Multi-PID 3 = Multi-Purpose
P21.1.3 ①	Parameter Sets					619	
P21.1.4	Up To Keypad					620	See Par ID 2118
P21.1.5 ①	Down From Keypad					621	
P21.1.6	Parameter Comparison					623	
P21.1.7	Password	0	9999		0	624	
P21.1.8	Parameter Lock				0	625	
P21.1.9	Multimonitor Set				0	627	See Par ID 2462
P21.1.10	Default Page				2	628	
P21.1.11	Timeout Time	0	65535	s	30	629	
P21.1.12	Contrast Adjust	5	18		12	630	
P21.1.13	Backlight Time	1	65535	min	10	631	
P21.1.14	Fan Control				1	632	
P21.1.15	Keypad ACK Timeout	200	5000	ms	200	633	
P21.1.16	Keypad Retry Number	1	10		5	634	
P21.1.17	Startup Wizard				0	626	
P21.1.18	Jog Softkey Hidden				0	2412	See Par ID 2462
P21.1.19	Reverse Softkey Hidden				0	2413	See Par ID 2462

- Notes:**
- ① Parameter value can only be changed after the drive has stopped.
  - ② Parameter value will be set to be default when changing macros.
  - ③ Input function is level sensed.
  - ④ Input function is edge sensed.
  - ⑤ Input function is edge sensed when using StartP/StopP start logic.

**Table 145. Basic setting—P21.1, continued.**

Code	Parameter	Min.	Max.	Unit	Default	ID	Note
P21.1.20	Output Display Unit				45	2424	
P21.1.21	Output Display Unit Min	-60000.00	See Par ID 2425	Varies	0.00	2460	
P21.1.22	Output Display Unit Max	See Par ID 2460	60000.00	Varies	MotorNomFreqMFG	2425	
P21.1.23	Keypad Lock Password	0	9999		0	75	

**Table 146. Version info.—P21.2.**

Code	Parameter	Min.	Max.	Unit	Default	ID	Note
P21.2.1	Keypad Software Version					640	
P21.2.2	Motor Control Software Version					642	
P21.2.3	Application Software Version					644	
P21.2.4	Software Bundle Version					1714	

**Table 147. Application info.—P21.3.**

Code	Parameter	Min.	Max.	Unit	Default	ID	Note
P21.3.1	Brake Chopper Status					646	See Par ID 2118
P21.3.2	Brake Resistor Status					647	See Par ID 2118
P21.3.3	Serial Number					648	
P21.3.4	Power Unit Serial Number					1270	
P21.3.5	Control Unit Serial Number					1276	

**Table 148. User info.—P21.4.**

Code	Parameter	Min.	Max.	Unit	Default	ID	Note
P21.4.1	Real Time Clock				0.0.0.1:1:13	566	
P21.4.2	Daylight Saving				0	582	
P21.4.3	Total MWh Count			Mwh		601	
P21.4.4	Total Power Day Count					603	
P21.4.5	Total Power Hr Count					606	
P21.4.6	Trip MWh Count			Mwh		604	
P21.4.7	Clear Trip MWh Count					635	See Par ID 2125
P21.4.8	Trip Power Day Count					636	
P21.4.9	Trip Power Hr Count					637	
P21.4.10	Clear Trip Power Count					639	See Par ID 2125

**Table 149. Operate mode—O.**

Code	Parameter	Min.	Max.	Unit	Default	ID	Note
O1	Output Frequency			Hz		1	
O2	Freq Reference			Hz		24	
O3	Motor Speed			rpm		2	
O4	Motor Current			A		3	
O5	Motor Torque			%		4	
O6	Motor Power			%		5	
O7	Motor Voltage			V		6	

- Notes:**
- ① Parameter value can only be changed after the drive has stopped.
  - ② Parameter value will be set to be default when changing macros.
  - ③ Input function is level sensed.
  - ④ Input function is edge sensed.
  - ⑤ Input function is edge sensed when using StartP/StopP start logic.

**Table 149. Operate mode—O, continued.**

<b>Code</b>	<b>Parameter</b>	<b>Min.</b>	<b>Max.</b>	<b>Unit</b>	<b>Default</b>	<b>ID</b>	<b>Note</b>
O8	DC-link Voltage			V		7	
O9	Unit Temperature			Deg. C		8	
O10	Motor Temperature			%		9	
R12	Keypad Reference	See Par ID 101	See Par ID 102	Hz	0.00	141	
R13	PID1 Keypad Set Point 1	See Par ID 1298	See Par ID 1300	Varies	0.00	1307	
R14	PID1 Keypad Set Point 2	See Par ID 1298	See Par ID 1300	Varies	0.00	1309	

- Notes:**
- ① Parameter value can only be changed after the drive has stopped.
  - ② Parameter value will be set to be default when changing macros.
  - ③ Input function is level sensed.
  - ④ Input function is edge sensed.
  - ⑤ Input function is edge sensed when using StartP/StopP start logic.



## Chapter 8—Multi-purpose application

### Introduction

The Multi-purpose application is designed for a large set of applications with the ability to have advanced motor control systems. It takes the same functions provided in the Standard, Multi-pump and Fan, and Multi-PID applications and adds in some additional control techniques. The application is designed with 2 control places that use 8 digital inputs, 2 analog inputs, 3 relay outputs, 1 digital output, and 2 analog outputs that are programmable. Motor controlwise, it provides the ability to do frequency and speed control and adds Open Loop Speed Control as well as Torque Control. For tuning the V/Hz curve, it has the ability to go out and ID the motor characteristic and enters those specific measurements into its parameters for better control. Drive/motor protections are programmable for desired actions depending on the application. Below is a list of additional features available in addition to the Standard, Multi-pump and Fan, and Multi-PID application features that are available in the Multi-purpose application.

- Motor potentiometer reference control
- External brake control
- Droop function with multiple loads
- Motor identification
- Motor control modes
- I/O Controls
  - “Terminal to Function” (TTF) Programming

The design behind the programming of the digital inputs in the DG1 drive is to use “Terminal to Function” programming. It is composed of multiple functions that get assigned a digital input to that function, the parameters in the drive are set up with specific functions and by defining the digital input and slot in some cases depending on the what options are available. For use of the drives control board inputs they will be referred to as DigIN:1 through DigIN:8. When additional option cards are used, they will be defined as DigIN:X:IOY:Z. The X indicates the slot that the card is being installed in which will be either A or B, then the IOY determines the type of card it is, which would be IO1 or IO5, and the Z would indicate which input is being used on that available option card.

- “Function to Terminal” (FTT) Programming

The design behind the programming of the relay outputs and digital output in the DG1 drive is to use “Function to Terminal” programming. It is composed of a terminal be it a relay output or a digital output that is assigned a parameter. Within that parameter, it has different functions that can be set.

The parameters of the Multi-purpose application are explained on **Page 151** of this manual, “Description of Parameters.” The explanations are arranged according to the parameter number.

For the DI function, we use terminal programming method to function (TTF), where there is a fixed input that gets programmed to a list of functions. This allows for multiple inputs to be used for different functions. Connecting a certain input with a certain parameter function is done by give a parameter an appropriate value. The value is formed by the location of the input, either being on the standard control board or an external option board and the slot in which it is located.

### Force Open/Force Close selection

The Force Open selection would make the selected function always off. Essentially this is a virtual switch that is always open.

The Force Close selection would make the selected function always on. Essentially this is a virtual switch that is always closed.

These options are assigned to a function if we want to force a state without using a hardware input.

### Example:

If we set Run Enable to Force Closed, the drive is always enabled. If we set the same function to Force Open, the drive would never be enabled. If a digital input is to be used to activate this Run Enable, the function should be assigned to a hardware input (see below for DIGIN selections).

## Chapter 8—Multi-purpose application

### **DIGIN selection**

This allows assignment of a hardware digital input to a function, this is set in a format of Digin:X where X is one of the 8 digital inputs on the main control board.

#### **Example:**

If we set Run Enable to Digin:6, the drive will be enabled when digital input 6 (terminal 8) is closed, and would not be enabled when digital input 6 (terminal 8) is open.

### **Option board Digin selection**

This allows assignment of a hardware digital input on an option card to a function, this is set in a format of Digin:Y:IO1:X where Y is the slot the option card is inserted on the main control board and X is the input on the board and IO1 is the type of option board used.

#### **Example:**

If we set Run Enable to Digin:A:IO5:6, the drive will be enabled when digital input 6 is closed on the IO5 option card which is inserted in Slot A, and would not be enabled when digital input 6 on the option card is open.

### **Time Channel selection**

A Time Channel is a virtual path to link the digital output of a timer function to a digital input function. To utilize this feature a timer or interval would need to be assigned to a time channel 1 through 3, and the input function to be controlled would need to be assigned to the same time channel.

#### **Example:**

If we set Run Enable to Digin:TimeChannel1, the drive will be enabled when the timer assigned to Time Channel 1 is active or High, and would not be enabled when the Time Channel is inactive or Low.

### Control I/O configuration

- Run 240 Vac and 24 Vdc control wiring in separate conduit
- Communication wire to be shielded

**Table 150. Multi-purpose application default I/O configuration.**

Default

	OFF	ON
AI1: 0 to 10 V	1	
AI2	2	
AI2	3	

AI1: 0 to 20 mA

	OFF	ON
	2	
	3	

AI2: 0 to 20 mA

	OFF	ON
	2	
	3	

AI2: 0 to 10 V

	OFF	ON
	2	
	3	

AI2: -10 V to +10 V

External wiring	Pin	Signal name	Signal	Default setting	Description
	1	+10 V	Ref. Output Voltage	—	10 Vdc Supply Source
	2	AI1+ ⊕	Analog Input 1	0–10 V	Voltage Speed Reference (Programmable to 4 mA to 20 mA)
	3	AI1–	Analog Input 1 Ground	—	Analog Input 1 Common (Ground)
	4	AI2+ ⊕	Analog Input 2	4 mA to 20 mA	Current Speed Reference (Programmable to 0–10 V)
	5	AI2–	Analog Input 2 Ground	—	Analog Input 2 Common (Ground)
	6	GND	I/O Signal Ground	—	I/O Ground for Reference and Control
	7	DIN5	Digital Input 5	Preset Speed B0	Sets frequency output to Preset Speed 1
	8	DIN6	Digital Input 6	Preset Speed B1	Sets frequency output to Preset Speed 2
	9	DIN7	Digital Input 7	Not Used (TI–)	Input forces VFD output to shut off
	10	DIN8	Digital Input 8	Force Remote (TI+)	Input takes VFD from Local to Remote
	11	CMB	DI5 to DI8 Common	Grounded	Allows source input
	12	GND	I/O Signal Ground	—	I/O Ground for Reference and Control
	13	24 V	+24 Vdc Output	—	Control voltage output (100 mA max.)
	14	DO1	Digital Output 1	Ready	Shows the drive is ready to run
	15	24 Vo	+24 Vdc Output	—	Control voltage output (100 mA max.)
	16	GND	I/O Signal Ground	—	I/O Ground for Reference and Control
	17	AO1+	Analog Output 1	Output Frequency	Shows Output frequency to motor 0–60 Hz (4 mA to 20 mA)
	18	AO2+	Analog Output 2	Motor Current	Shows Motor current of motor 0–FLA (4 mA to 20 mA)
	19	24 Vi	+24 Vdc Input	—	External control voltage input
	20	DIN1	Digital Input 1	Run Forward	Input starts drive in forward direction (start enable)
	21	DIN2	Digital Input 2	Run Reverse	Input starts drive in reverse direction (start enable)
	22	DIN3	Digital Input 3	External Fault	Input causes drive to fault
	23	DIN4	Digital Input 4	Fault Reset	Input resets active faults
	24	CMA	DI1 to DI4 Common	Grounded	Allows source input
	25	A/+	RS-485 Signal A	—	Fieldbus Communication (Modbus, BACnet)
	26	B/-	RS-485 Signal B	—	Fieldbus Communication (Modbus, BACnet)
	27	R3NO	Relay 3 Normally Open	At Speed	Relay output 3 shows VFD is at Ref. Frequency
	28	R1NC	Relay 1 Normally Closed	Run	Relay output 1 shows VFD is in a run state
	29	R1CM	Relay 1 Common		
	30	R1NO	Relay 1 Normally Open		
	31	R3CM	Relay 3 Common	At Speed	Relay output 3 shows VFD is at Ref. Frequency
	32	R2NC	Relay 2 Normally Closed	Fault	Relay output 2 shows VFD is in a fault state
	33	R2CM	Relay 2 Common		
	34	R2NO	Relay 2 Normally Open		

**Notes:** The above wiring demonstrates a SINK configuration. It is important that CMA and CMB are wired to ground (as shown by dashed line). If a SOURCE configuration is desired, wire 24 V to CMA and CMB and close the inputs to ground. When using the +10 V for AI1, it is important to wire AI1– to ground (as shown by dashed line). If using +10 V for AI1 or AI2, terminals 3, 5, and 6 need to be jumpered together.  
 ⊕ AI1+ and AI2+ support 10K potentiometer.

## Chapter 8—Multi-purpose application

**Table 151. Drive communication ports.**

<b>Port</b>	<b>Communication</b>
<b>RJ45 Keypad Port</b>	
Upload/Download Parameters	USB to RJ45
Remote Mount Keypad	Ethernet
Upgrade Drive Firmware	USB to RJ45
<b>RJ45 Ethernet Port</b>	
Upload/Download Parameters	Ethernet
Ethernet IP Communications	Ethernet
Modbus TCP Communications	Ethernet
<b>RS-485 Serial Port</b> ①	
Upload/Download Parameters	Two-Wire Twisted Pair
Upgrade Drive Firmware	Two-Wire Twisted Pair
Modbus RTU Communications	Two-Wire Twisted Pair
BACnet MS/TP Communications	Two-Wire Twisted Pair

① Shielded wire recommended.

## Multi-purpose application—parameters list

On the next pages you will find the lists of parameters within the respective parameter groups. The parameter descriptions are given on **Page 194**, “Description of Parameters.” The descriptions are arranged according to the parameter number.

Column explanations:

Code = Location indication on the keypad; shows the operator the present parameter number

Parameter = Name of parameter

Min = Minimum value of parameter

Max = Maximum value of parameter

Unit = Unit of parameter value; given if available

Default = Value preset by factory

ID = ID number of the parameter

**Table 152. Monitor—M.**

Code	Parameter	Min.	Max.	Unit	Default	ID	Note
M1	Output Frequency			Hz		1	
M2	Freq Reference			Hz		24	
M3	Motor Speed			rpm		2	
M4	Motor Current			A		3	
M5	Motor Torque			%		4	
M6	Motor Power			%		5	
M7	Motor Voltage			V		6	
M8	DC-link Voltage			V		7	
M9	Unit Temperature			Deg. C		8	
M10	Motor Temperature			%		9	
M11	Torque Reference			%		15	
M12	Analog Input 1			Varies		10	
M13	Analog Input 2			Varies		11	
M14	Analog Output 1			Varies		25	
M15	Analog Output 2			Varies		575	
M16	DI1, DI2, DI3					12	
M17	DI4, DI5, DI6					13	
M18	DI7, DI8					576	
M19	DO1,Virtual RO1,Virtual RO2					14	
M20	RO1, RO2, RO3					557	
M21	TC1, TC2, TC3					558	
M22	Interval 1					559	0 = Inactive 1 = Active
M23	Interval 2					560	See Par ID 559
M24	Interval 3					561	See Par ID 559
M25	Interval 4					562	See Par ID 559
M26	Interval 5					563	See Par ID 559
M27	Timer 1			s	0	569	
M28	Timer 2			s	0	571	
M29	Timer 3			s	0	573	
M30	PID1 Set Point			Varies		16	
M31	PID1 Feedback			Varies		18	
M32	PID1 Error Value			Varies		20	
M33	PID1 Output			%		22	

- Note:**
- ① Parameter value can only be changed after the drive has stopped.
  - ② Parameter value will be set to be default when changing macros.
  - ③ Input function is level sensed.
  - ④ Input function is edge sensed.
  - ⑤ Input function is edge sensed when using StartP/StopP start logic.

## Chapter 8—Multi-purpose application

**Table 152. Monitor—M, continued.**

Code	Parameter	Min.	Max.	Unit	Default	ID	Note
M34	PID1 Status					23	0 = Stopped 1 = Running 2 = Sleep Mode
M35	PID2 Set Point			Varies		32	
M36	PID2 Feedback			Varies		34	
M37	PID2 Error Value			Varies		36	
M38	PID2 Output			%		38	
M39	PID2 Status					39	See Par ID 23
M40	Running Motors					26	
M41	PT100 Temperature			Deg. C	1000.0	27	
M42	Latest Fault Code					28	
M43	RTC Battery Status				0	583	0 = Not Installed 1 = Installed 2 = Change Battery 3 = OverVoltage
M44	Instant Motor Power			kW		1686	
M45	Energy Savings			Varies	0.000	2120	
M46	Control Board DIDO Status					2209	
M47	SlotA DIDO Status					2210	
M48	SlotB DIDO Status					2211	
M49	Application Status Word					29	
M50	Standard Status Word					2414	
M51	Output			Varies		2445	
M52	Reference			Varies		2447	
M53	Total MWh Count			Mwh		601	
M54	Total Power Day Count					603	
M55	Total Power Hr Count					606	
M56	Trip MWh Count			Mwh		604	
M57	Trip Power Day Count					636	
M58	Trip Power Hr Count					637	
M59	Total Run time Count			h		2827	
M60	Numbers Of Start					2830	
M61	Trip Run Time Count			h		2829	
M62	FB Status Word					2101	
M63	FB Ctrol Word					2001	
M64	FB Speed Reference	0.00	100.00	%		2003	
M65	Multi-monitoring				2, 1, 3, 2, 1, 3, 2, 1, 3	1753	

- Note:**
- ① Parameter value can only be changed after the drive has stopped.
  - ② Parameter value will be set to be default when changing macros.
  - ③ Input function is level sensed.
  - ④ Input function is edge sensed.
  - ⑤ Input function is edge sensed when using StartP/StopP start logic.

## Parameters

Table 153. Basic parameters—P1.

Code	Parameter	Min.	Max.	Unit	Default	ID	Note
P1.1	Min Frequency	0.00	See Par ID 102	Hz	0.00	101	
P1.2 ①	Max Frequency	See Par ID 101	400.00	Hz	MaxFreqMFG	102	
P1.3	Accel Time 1	0.1	3000.0	s	3.0	103	
P1.4	Decel Time 1	0.1	3000.0	s	3.0	104	
P1.5 ①	Motor Nom Current	DriveNomCurrCT*1/10	DriveNomCurrCT*2	A	DriveNomCurrCT	486	
P1.6 ①	Motor Nom Speed	300	24000	rpm	MotorNomSpeedMFG	489	
P1.7 ①	Motor PF	0.30	1.00		0.85	490	
P1.8 ①	Motor Nom Voltage	180	690	V	MotorNomVoltMFG	487	
P1.9 ①	Motor Nom Frequency	8.00	400.00	Hz	MotorNomFreqMFG	488	
P1.10	Power Up Local Remote Select				0	1685	0 = Hold Last 1 = Local Control 2 = Remote control
P1.11	Remote 1 Control Place				0	135	0 = I/O Terminal Start 1 1 = Fieldbus 2 = I/O Terminal Start 2 3 = Keypad
P1.12	Local Control Place				0	1685	0 = Keypad 1 = I/O Terminal Start 1 2 = I/O Terminal Start 2 3 = Fieldbus
P1.13	Bumpless Enable				0	2462	0 = Disabled 1 = Enabled
P1.14 ①②	Local Reference				6	136	0 = AI1 1 = AI2 2 = Slot A: AI1 3 = Slot B: AI1 4 = AI1 Joystick 5 = AI2 Joystick 6 = Keypad 7 = Fieldbus Ref 8 = Motor Pot 9 = Max Frequency 10 = AI1 + AI2 11 = AI1 - AI2 12 = AI2 - AI1 13 = AI1 * AI2 14 = AI1 or AI2 15 = MIN(AI1,AI2) 16 = MAX(AI1,AI2) 17 = PID1 Control Output 18 = PID2 Control Output
P1.15 ①②	Remote 1 Reference				0	137	See Par ID 136
P1.16 ①	Reverse Enable				1	1679	See Par ID 2462
P1.17	Run Delay Time	0	32500	s	0	2423	
P1.18 ①	HOA Source				0	2465	0 = Disabled 1 = IO Terminal 2 = Keypad
P1.19 ①	Minimum Run Time	0	32500	s	0	1813	
P1.20	Frequency Reference Upper Limit	See Par ID 101	See Par ID 102	Hz	50.00	2840	
P1.21	Frequency Reference Upper Limit Source				0	2841	0 = Not Used 1 = Freq Ref Upper 2 = AI1 3 = AI2
P1.22 ①②	Motor Type Selection				0	1820	0 = Inverter Duty 1 = IPM 2 = SPM

**Note:** ① Parameter value can only be changed after the drive has stopped.  
 ② Parameter value will be set to be default when changing macros.  
 ③ Input function is level sensed.  
 ④ Input function is edge sensed.  
 ⑤ Input function is edge sensed when using StartP/StopP start logic.

## Analog input

**Table 154. Basic setting—P2.1.**

Code	Parameter	Min.	Max.	Unit	Default	ID	Note
P2.1.1	AI Ref Scale Min Value	0.00	See Par ID 145	Hz	0.00	144	
P2.1.2	AI Ref Scale Max Value	See Par ID 144	400.00	Hz	0.00	145	

**Table 155. AI1 settings—P2.2.**

Code	Parameter	Min.	Max.	Unit	Default	ID	Note
P2.2.1	AI1 Mode				1	222	0 = 0–20 mA 1 = 0–10 V
P2.2.2	AI1 Signal Range				0	175	0 = 0–100%/0–20 mA/0–10 V 1 = 20–100%/4–20 mA/2–10 V 2 = Customized
P2.2.3	AI1 Custom Min	0.00	See Par ID 177	%	0.00	176	
P2.2.4	AI1 Custom Max	See Par ID 176	100.00	%	100.00	177	
P2.2.5	AI1 Filter Time	0.00	10.00	s	0.10	174	
P2.2.6	AI1 Signal Invert				0	181	0 = Not Inverted 1 = Inverted
P2.2.7	AI1 Joystick Hyst	0.00	20.00	%	0.00	178	
P2.2.8	AI1 Sleep Limit	0.00	100.00	%	0.00	179	
P2.2.9	AI1 Sleep Delay	0.00	320.00	s	0.00	180	
P2.2.10	AI1 Joystick Offset	-50.00	50.00	%	0.00	133	

**Table 156. AI2 settings—P2.3.**

Code	Parameter	Min.	Max.	Unit	Default	ID	Note
P2.3.1	AI2 Mode				0	223	0 = 0–20 mA 1 = 0–10 V 2 = –10 to +10 V
P2.3.2	AI2 Signal Range				1	183	0 = 0–100%/0–20 mA/ 0–10 V –10 to 10 V 1 = 20–100%/4–20 mA/ 2–10 V/–6- to 10 V 2 = Customized
P2.3.3	AI2 Custom Min	0.00	See Par ID 185	%	0.00	184	
P2.3.4	AI2 Custom Max	See Par ID 184	100.00	%	100.00	185	
P2.3.5	AI2 Filter Time	0.00	10.00	s	0.10	182	
P2.3.6	AI2 Signal Invert				0	189	See Par ID 181
P2.3.7	AI2 Joystick Hyst	0.00	20.00	%	0.00	186	
P2.3.8	AI2 Sleep Limit	0.00	100.00	%	0.00	187	
P2.3.9	AI2 Sleep Delay	0.00	320.00	s	0.00	188	
P2.3.10	AI2 Joystick Offset	-50.00	50.00	%	0.00	134	

**Table 157. Fine adjust—P2.4.**

Code	Parameter	Min.	Max.	Unit	Default	ID	Note
P2.4.1 ①	Fine Tuning Input				0	2484	0 = Not Used 1 = AI1 2 = AI2 3 = Slot A: AI1 4 = Slot B: AI1 5 = Fieldbus
P2.4.2 ②	Fine Tuning Min	0.0	100.0	%	0.0	2485	
P2.4.3 ②	Fine Tuning Max	0.0	100.0	%	0.0	2486	

**Note:** ① Parameter value can only be changed after the drive has stopped.  
 ② Parameter value will be set to be default when changing macros.  
 ③ Input function is level sensed.  
 ④ Input function is edge sensed.  
 ⑤ Input function is edge sensed when using StartP/StopP start logic.



**Table 158. Digital input—P3.**

Code	Parameter	Min.	Max.	Unit	Default	ID	Note
P3.1 ①	IO Terminal 1 Start Stop Logic				0	143	0 = Forward - Reverse 1 = Start - Reverse 2 = Start - Enable 3 = 3 Wire Control
P3.2 ②⑤	IO Terminal 1 Start Signal 1				2	190	0 = DigIN:NormallyOpen 1 = DigIN:NormallyClose 2 = DigIN: 1 3 = DigIN: 2 4 = DigIN: 3 5 = DigIN: 4 6 = DigIN: 5 7 = DigIN: 6 8 = DigIN: 7 9 = DigIN: 8 10 = DigIN: A: IO1: 1 11 = DigIN: A: IO1: 2 12 = DigIN: A: IO1: 3 13 = DigIN: A: IO5: 1 14 = DigIN: A: IO5: 2 15 = DigIN: A: IO5: 3 16 = DigIN: A: IO5: 4 17 = DigIN: A: IO5: 5 18 = DigIN: A: IO5: 6 19 = DigIN: B: IO1: 1 20 = DigIN: B: IO1: 2 21 = DigIN: B: IO1: 3 22 = DigIN: B: IO5: 1 23 = DigIN: B: IO5: 2 24 = DigIN: B: IO5: 3 25 = DigIN: B: IO5: 4 26 = DigIN: B: IO5: 5 27 = DigIN: B: IO5: 6 28 = Time Channel 1 29 = Time Channel 2 30 = Time Channel 3 31 = RO1 Function 32 = RO2 Function 33 = RO3 Function 34 = Virtual RO1 Function 35 = Virtual RO2 Function
P3.3 ②⑤	IO Terminal 1 Start Signal 2				3	191	See Par ID 190
P3.4 ①	Thermistor Input Select				0	881	0 = Digital Input 1 = Thermistor Input
P3.5 ②③	Reverse				0	198	See Par ID 190
P3.6 ②③	Ext. Fault 1 NO				4	192	See Par ID 190
P3.7 ②③	Ext. Fault 1 NC				1	193	See Par ID 190
P3.8 ②④	Fault Reset				5	200	See Par ID 190
P3.9 ②③	Run Enable				1	194	See Par ID 190
P3.10 ②③	Preset Speed B0				6	205	See Par ID 190
P3.11 ②③	Preset Speed B1				7	206	See Par ID 190
P3.12 ②③	Preset Speed B2				0	207	See Par ID 190
P3.13 ②③	PID1 Control Enable				1	550	See Par ID 190
P3.14 ②③	PID2 Control Enable				1	553	See Par ID 190
P3.15 ②③	Accel/Decel Time Set				0	195	See Par ID 190
P3.16 ②③	Accel/Decel Prohibit				0	201	See Par ID 190
P3.17 ②④	No Access To Param				0	215	See Par ID 190
P3.18 ②③	Accel Pot Value				0	203	See Par ID 190
P3.19 ②③	Decel Pot Value				0	204	See Par ID 190
P3.20 ②③	Reset Pot Zero				0	216	See Par ID 190
P3.21 ②③	Remote Control				9	196	See Par ID 190

**Note:** ① Parameter value can only be changed after the drive has stopped.  
 ② Parameter value will be set to be default when changing macros.  
 ③ Input function is level sensed.  
 ④ Input function is edge sensed.  
 ⑤ Input function is edge sensed when using StartP/StopP start logic.

## Chapter 8—Multi-purpose application

**Table 158. Digital input—P3, continued.**

Code	Parameter	Min.	Max.	Unit	Default	ID	Note
P3.22 ②③	Local Control				0	197	See Par ID 190
P3.23 ②③	Remote 1/2 Select				0	209	See Par ID 190
P3.24 ②③	Second Motor Para Select				0	217	See Par ID 190
P3.25 ②③	Force Bypass				0	218	See Par ID 190
P3.26 ②③	DC Brake Active				0	202	See Par ID 190
P3.27 ②③	Smoke Mode				0	219	See Par ID 190
P3.28 ②③	Fire Mode				0	220	See Par ID 190
P3.29 ②③	Fire Mode Ref 1/2 Select				0	221	See Par ID 190
P3.30 ②③	PID1 Set Point Select				0	351	See Par ID 190
P3.31 ②③	PID2 Set Point Select				0	352	See Par ID 190
P3.32 ②③	Jog Enable				0	199	See Par ID 190
P3.33 ③	Start Timer 1				0	224	See Par ID 190
P3.34 ③	Start Timer 2				0	225	See Par ID 190
P3.35 ③	Start Timer 3				0	226	See Par ID 190
P3.36 ②③	AI Ref Source Select				0	208	See Par ID 190
P3.37 ②③	Motor Interlock 1				0	210	See Par ID 190
P3.38 ②③	Motor Interlock 2				0	211	See Par ID 190
P3.39 ②③	Motor Interlock 3				0	212	See Par ID 190
P3.40 ②③	Motor Interlock 4				0	213	See Par ID 190
P3.41 ②③	Motor Interlock 5				0	214	See Par ID 190
P3.42 ②③	Ext Fault-AR				1	747	See Par ID 190
P3.43 ②③	Bypass Overload				0	1246	See Par ID 190
P3.44 ②③	Fire Mode Direction Invert				0	2119	See Par ID 190
P3.45 ①	IO Terminal 2 Start Stop Logic				0	2206	See Par ID 143
P3.46 ② ⑤	IO Terminal 2 Start Signal 1				2	2207	See Par ID 190
P3.47 ② ⑤	IO Terminal 2 Start Signal 2				3	2208	See Par ID 190
P3.48 ②③	Ext. Fault 2 NO				0	2293	See Par ID 190
P3.49 ②③	Ext. Fault 2 NC				1	2294	See Par ID 190
P3.50 ②③	Ext. Fault 3 NO				0	2295	See Par ID 190
P3.51 ②③	Ext. Fault 3 NC				1	2296	See Par ID 190
P3.52	Ext. Fault 1 Text				0	2297	0 = External Fault 1 = Vibration Cut out 2 = High Motor temp 3 = Low Pressure 4 = High Pressure 5 = Low Water 6 = Damper Interlock 7 = Run Enable 8 = Freeze Stat Trip 9 = Smoke Detect 10 = Seal Leakage 11 = Rod Breakage 12 = Torque Limit
P3.53	Ext. Fault 2 Text				1	2298	See Par ID 2297
P3.54	Ext. Fault 3 Text				2	2299	See Par ID 2297
P3.55 ②④	Parameter Set1/2 Sel				0	2312	See Par ID 190
P3.56 ②③	Deragging Enable				0	2394	See Par ID 190
P3.57 ②③	HOA On/Off				1	2395	See Par ID 190
P3.58 ③	Multi-pump Mode 1/2 Select				0	2658	See Par ID 190
P3.59 ②③	OP Cont Interlock NO				4	2801	See Par ID 190

**Note:** ① Parameter value can only be changed after the drive has stopped.  
 ② Parameter value will be set to be default when changing macros.  
 ③ Input function is level sensed.  
 ④ Input function is edge sensed.  
 ⑤ Input function is edge sensed when using StartP/StopP start logic.

**Table 158. Digital input—P3, continued.**

Code	Parameter	Min.	Max.	Unit	Default	ID	Note
P3.60 ②③	OP Cont Interlock NC				1	2802	See Par ID 190
P3.61 ③	CP Interlock NC				1	2894	See Par ID 190

**Table 159. Analog output—P4.**

Code	Parameter	Min.	Max.	Unit	Default	ID	Note
P4.1	A01 Mode				0	227	See Par ID 222
P4.2 ②	A01 Function				1	146	0 = Not Used 1 = Output Frequency 2 = Freq Reference 3 = Motor Speed 4 = Motor Current 5 = Motor Torque (0-Nom) 6 = Motor Power 7 = Motor Voltage 8 = DC-Bus Voltage 9 = PID1 Setpoint 10 = PID1 Feedback 1 11 = PID1 Feedback 2 12 = PID1 Control Error Value 13 = PID1 Control Output 14 = PID2 Setpoint 15 = PID2 Feedback 1 16 = PID2 Feedback 2 17 = PID2 Control Error Value 18 = PID2 Control Output 19 = AI1 20 = AI2 21 = Output Freq (-2-+2N) 22 = Motor Torque (-2-+2N) 23 = Motor Power (-2-+2N) 24 = PT100 Temperature 25 = FB Process Data Input 1 26 = FB Process Data Input 2 27 = FB Process Data Input 3 28 = FB Process Data Input 4 29 = FB Process Data Input 5 30 = FB Process Data Input 6 31 = FB Process Data Input 7 32 = FB Process Data Input 8 33 = SlotA PT100 Temp Channel 1 34 = SlotA PT100 Temp Channel 2 35 = SlotA PT100 Temp Channel 3 36 = SlotB PT100 Temp Channel 1 37 = SlotB PT100 Temp Channel 2 38 = SlotB PT100 Temp Channel 3 39 = User Defined Output 40 = Motor Current (-2-+2N)

- Note:**
- ① Parameter value can only be changed after the drive has stopped.
  - ② Parameter value will be set to be default when changing macros.
  - ③ Input function is level sensed.
  - ④ Input function is edge sensed.
  - ⑤ Input function is edge sensed when using StartP/StopP start logic.

**Table 159. Analog output—P4, continued.**

Code	Parameter	Min.	Max.	Unit	Default	ID	Note
P4.3	AO1 Minimum				1	149	0 = 0V / 0 mA 1 = 2V / 4 mA
P4.4	AO1 Filter Time	0.00	10.00	s	1.00	147	
P4.5	AO1 Scale	10	1000	%	100	150	
P4.6	AO1 Inversion				0	148	See Par ID 181
P4.7	AO1 Offset	-100.00	100.00	%	0.00	173	
P4.8	AO2 Mode				0	228	See Par ID 222
P4.9 ②	AO2 Function				4	229	See Par ID 146
P4.10	AO2 Minimum				1	232	See Par ID 149
P4.11	AO2 Filter Time	0.00	10.00	s	1.00	230	
P4.12	AO2 Scale	10	1000	%	100	233	
P4.13	AO2 Inversion				0	231	See Par ID 181
P4.14	AO2 Offset	-100.00	100.00	%	0.00	234	

**Table 160. Digital output—P5.**

Code	Parameter	Min.	Max.	Unit	Default	ID	Note
P5.1 ②	DO1 Function				1	151	0 = Not Used 1 = Ready 2 = Run 3 = Fault 4 = Fault Invert 5 = Warning 6 = Reversed 7 = At Speed 8 = Zero Frequency 9 = Freq Limit 1 Superv 10 = Freq Limit 2 Superv 11 = PID1 Superv 12 = PID2 Superv 13 = OverHeat Fault 14 = OverCurrent Regular 15 = OverVoltage Regular 16 = UnderVoltage Regular 17 = 4mA Ref Fault/ Warning 18 = Ext Brake Control 19 = Ext Brake Inverted 20 = Torq Limit Superv 21 = Ref Limit Superv 22 = Control from I/O 23 = Un-Requested Rotation Direction 24 = Thermistor Fault Output 25 = Fire Mode 26 = In Bypass Mode 27 = Ext Fault/Warning 28 = Remote Control 29 = Jog Speed Select 30 = Motor Therm Protection 31 = FB Digital Input 1 32 = FB Digital Input 2 33 = FB Digital Input 3 34 = FB Digital Input 4 35 = Damper Control 36 = TC1 Status 37 = TC2 Status 38 = TC3 Status 39 = In E-Stop 40 = Power Limit Superv

- Note:** ① Parameter value can only be changed after the drive has stopped.  
 ② Parameter value will be set to be default when changing macros.  
 ③ Input function is level sensed.  
 ④ Input function is edge sensed.  
 ⑤ Input function is edge sensed when using StartP/StopP start logic.

**Table 160. Digital output—P5, continued.**

Code	Parameter	Min.	Max.	Unit	Default	ID	Note
P5.1 ②, continued	DO1 Function				1	151	41 = Temp Limit Superv 42 = Analog Input Superv 43 = Motor 1 Control 44 = Motor 2 Control 45 = Motor 3 Control 46 = Motor 4 Control 47 = Motor 5 Control 48 = Logic Fulfilled 49 = PID1 Sleep 50 = PID2 Sleep 51 = Motor Current 1 Supv 52 = Motor Current 2 Supv 53 = Second AI Limit Supv 54 = DC Charge Switch Close 55 = Preheat Active 56 = Cold Weather Active 57 = Prime Pump Active 58 = 2th Stage Ramp Frequency Active 59 = STO Fault Output 60 = Run Bypass/Drive 61 = Bypass Overload 62 = Bypass Run 63 = Auto Local On COM Fault 64 = FieldBus_RTU_Fault 65 = FieldBus_TCP_Fault 66 = FieldBus_MSTP_Fault 67 = FieldBus_EIP_Fault 68 = FieldBus_SlotA_Fault 69 = FieldBus_SlotB Fault 70 = FieldBus SWD Fault 71 = Jockey Pump Active 72 = Lube Pump Active 73 = PID1 Low Feedback 74 = PID1 High Feedback 75 = PID2 Low Feedback 76 = PID2 High Feedback 77 = Master in MPFC 78 = CP Interlock Fault
P5.2 ②	RO1 Function				2	152	See Par ID 151
P5.3 ②	RO2 Function				3	153	See Par ID 151
P5.4 ②	RO3 Function				7	538	See Par ID 151
P5.5 ②	Virtual RO1 Function				0	2463	See Par ID 151
P5.6 ②	Virtual RO2 Function				0	2464	See Par ID 151
P5.7 ②	Freq Limit 1 Supv				0	154	0 = No Limit 1 = Low Limit Superv 2 = High Limit Superv 3 = Brake-on Control
P5.8	Freq Limit 1 Supv Val	0.00	See Par ID 102	Hz	0.00	155	
P5.9 ②	Freq Limit 2 Supv				0	157	0 = No Limit 1 = Low Limit Superv 2 = High Limit Superv 3 = Brake-off Control 4 = Brake-on/off Control
P5.10	Freq Limit 2 Supv Val	0.00	See Par ID 102	Hz	0.00	158	
P5.11 ②	Torque Limit Supv				0	159	0 = No Limit 1 = Low Limit Superv 2 = High Limit Superv 3 = Brake-off Control
P5.12 ②	Torque Limit Supv Val	-1000.0	1000.0	%	100.0	160	

**Note:** ① Parameter value can only be changed after the drive has stopped.  
 ② Parameter value will be set to be default when changing macros.  
 ③ Input function is level sensed.  
 ④ Input function is edge sensed.  
 ⑤ Input function is edge sensed when using StartP/StopP start logic.

## Chapter 8—Multi-purpose application

**Table 160. Digital output—P5, continued.**

Code	Parameter	Min.	Max.	Unit	Default	ID	Note
P5.13	Ref Limit Supv				0	161	0 = No Limit 1 = Low Limit Superv 2 = High Limit Superv
P5.14	Ref Limit Supv Val	0.00	See Par ID 102	Hz	0.00	162	
P5.15	Ext Brake Off Delay	0.0	100.0	s	0.5	163	
P5.16	Ext Brake On Delay	0.0	100.0	s	1.5	164	
P5.17	Temp Limit Supv				0	165	See Par ID 161
P5.18	Temp Limit Supv Val	-10.0	75.0	Deg. C	40.0	166	
P5.19	Power Limit Supv				0	167	See Par ID 161
P5.20	Power Limit Supv Val	-200.0	200.0	%	0.0	168	
P5.21	AI Supv Select				0	170	0 = AI1 1 = AI2
P5.22	AI Limit Supv				0	171	See Par ID 161
P5.23	AI Limit Supv Val	0.00	100.00	%	0.00	172	
P5.24	PID1 Superv Enable				0	1346	See Par ID 2462
P5.25	PID1 Superv Upper Limit	See Par ID 1298	See Par ID 1300	Varies	0.00	1347	
P5.26	PID1 Superv Lower Limit	See Par ID 1298	See Par ID 1300	Varies	0.00	1349	
P5.27	PID1 Superv Delay	0	3000	s	0	1351	
P5.28	PID2 Superv Enable				0	1408	See Par ID 2462
P5.29	PID2 Superv Upper Limit	See Par ID 1360	See Par ID 1362	Varies	0.00	1409	
P5.30	PID2 Superv Lower Limit	See Par ID 1360	See Par ID 1362	Varies	0.00	1411	
P5.31	PID2 Superv Delay	0	3000	s	0	1413	
P5.32	RO1 On Delay	0.0	320.0	s	0.0	2112	
P5.33	RO1 Off Delay	0.0	320.0	s	0.0	2113	
P5.34	RO2 On Delay	0.0	320.0	s	0.0	2114	
P5.35	RO2 Off Delay	0.0	320.0	s	0.0	2115	
P5.36	RO3 On Delay	0.0	320.0	s	0.0	2116	
P5.37	RO3 Off Delay	0.0	320.0	s	0.0	2117	
P5.38	RO3 Reverse				0	2118	0 = No 1 = Yes
P5.39 ②	Motor Current 1 Supv				0	2189	See Par ID 159
P5.40	Motor Current 1 Supv Value	0.0	DriveNomCurrCT*2	A	DriveNomCurrCT	2190	
P5.41 ②	Motor Current 2 Supv				0	2191	See Par ID 159
P5.42	Motor Current 2 Supv Value	0.0	DriveNomCurrCT*2	A	DriveNomCurrCT	2192	
P5.43	Second AI Supv Select				0	2193	See Par ID 170
P5.44	Second AI Limit Supv				0	2194	See Par ID 161
P5.45	Second AI Limit Supv Val	0.00	100.00	%	0.00	2195	
P5.46	Motor Current 1 Supv Hyst	0.1	1.0	A	0.1	2196	
P5.47	Motor Current 2 Supv Hyst	0.1	1.0	A	0.1	2197	
P5.48	AI Supv Hyst	1.00	10.00	%	1.00	2198	
P5.49	Second AI Supv Hyst	1.00	10.00	%	1.00	2199	

- Note:**
- ① Parameter value can only be changed after the drive has stopped.
  - ② Parameter value will be set to be default when changing macros.
  - ③ Input function is level sensed.
  - ④ Input function is edge sensed.
  - ⑤ Input function is edge sensed when using StartP/StopP start logic.

**Table 160. Digital output—P5, continued.**

<b>Code</b>	<b>Parameter</b>	<b>Min.</b>	<b>Max.</b>	<b>Unit</b>	<b>Default</b>	<b>ID</b>	<b>Note</b>
P5.50	Freq Limit 1 Supv Hyst	0.10	1.00	Hz	0.10	2200	
P5.51	Freq Limit 2 Supv Hyst	0.10	1.00	Hz	0.10	2201	
P5.52	Torque Limit Supv Hyst	1.0	5.0	%	1.0	2202	
P5.53	Ref Limit Supv Hyst	0.10	1.00	Hz	0.10	2203	
P5.54	Temp Limit Supv Hyst	1.0	10.0	Deg. C	1.0	2204	
P5.55	Power Limit Supv Hyst	0.1	10.0	%	0.1	2205	
P5.56	Virtual R01 On Delay	0.0	320.0	s	0.0	2848	
P5.57	Virtual R01 Off Delay	0.0	320.0	s	0.0	2849	
P5.58	Virtual R02 On Delay	0.0	320.0	s	0.0	2850	
P5.59	Virtual R02 Off Delay	0.0	320.0	s	0.0	2851	

- Note:**
- ① Parameter value can only be changed after the drive has stopped.
  - ② Parameter value will be set to be default when changing macros.
  - ③ Input function is level sensed.
  - ④ Input function is edge sensed.
  - ⑤ Input function is edge sensed when using StartP/StopP start logic.

## Chapter 8—Multi-purpose application

**Table 161. Logic function—P6.**

Code	Parameter	Min.	Max.	Unit	Default	ID	Note
P6.1	Logic Function Select				0	751	0 = AND 1 = OR 2 = XOR
P6.2 ②	Logic Operation Input A				0	752	0 = Not Used 1 = Ready 2 = Run 3 = Fault 6 = Reversed 7 = Warning 8 = Zero Frequency 9 = Control from I/O 14 = Run Bypass/Drive 15 = Ext Brake Control 16 = In Bypass Mode 17 = At Speed 18 = Remote Control 19 = Freq Limit 1 Superv 20 = Freq Limit 2 Superv 22 = PID1 Superv 23 = PID2 Superv 24 = OverHeat Fault 28 = 4mA Ref Fault/ Warning 29 = OverCurrent Regular 30 = OverVoltage Regular 31 = UnderVoltage Regular 32 = Torq Limit Superv 33 = Ref Limit Superv 34 = Un-Requested Rotation Direction 35 = Thermal Fault/ Warning 36 = Bypass Enable 37 = Jog Speed Select 38 = Motor Therm Protection 39 = FB Digital Input 1 40 = FB Digital Input 2 41 = FB Digital Input 3 42 = FB Digital Input 4 43 = Damper Control 44 = TC1 Status 45 = TC2 Status 46 = TC3 Status 47 = In E-Stop 48 = Power Limit Superv 49 = Temp Limit Superv 50 = Analog Input Superv 51 = Motor 1 Control 52 = Motor 2 Control 53 = Motor 3 Control 54 = Motor 4 Control 55 = Motor 5 Control 56 = Logic Fulfilled
P6.3 ③	Logic Operation Input B				0	753	See Par ID 752

- Note:**
- ① Parameter value can only be changed after the drive has stopped.
  - ② Parameter value will be set to be default when changing macros.
  - ③ Input function is level sensed.
  - ④ Input function is edge sensed.
  - ⑤ Input function is edge sensed when using StartP/StopP start logic.



**Table 162. Drive control—P7.**

Code	Parameter	Min.	Max.	Unit	Default	ID	Note
P7.1	Remote 2 Control Place				1	138	See Par ID 135
P7.2 ①②	Remote 2 Reference				7	139	See Par ID 136
P7.3	Keypad Reference	See Par ID 101	See Par ID 102	Hz	0.00	141	
P7.4	Keypad Direction				0	116	0 = Forward 1 = Reverse
P7.5	Keypad Stop				1	114	0 = Enabled-Keypad Operation 1 = Always Enabled
P7.6	Jog Reference	0.00	See Par ID 102	Hz	5.00	117	
P7.7	Motor Pot Ramp Time	0.1	2000.0	Hz/s	10.0	156	
P7.8	Motor Pot Ref Reset				0	169	0 = No Reset 1 = Reset: Stop + Power Down 2 = Reset: Power Down
P7.9	Start Mode				0	252	0 = Ramp 1 = Flying Start From Stop Frequency 2 = Flying Start From Max Frequency
P7.10	Stop Mode				1	253	0 = Coasting 1 = Ramp
P7.11	Ramp 1 Shape	0.0	10.0	s	0.0	247	
P7.12	Ramp 2 Shape	0.0	10.0	s	0.0	248	
P7.13	Accel Time 2	0.1	3000.0	s	10.0	249	
P7.14	Decel Time 2	0.1	3000.0	s	10.0	250	
P7.15	Skip F1 Low Limit	0.00	See Par ID 257	Hz	0.00	256	
P7.16	Skip F1 High Limit	See Par ID 256	400.00	Hz	0.00	257	
P7.17	Skip F2 Low Limit	0.00	See Par ID 259	Hz	0.00	258	
P7.18	Skip F2 High Limit	See Par ID 258	400.00	Hz	0.00	259	
P7.19	Skip F3 Low Limit	0.00	See Par ID 261	Hz	0.00	260	
P7.20	Skip F3 High Limit	See Par ID 260	400.00	Hz	0.00	261	
P7.21	Skip Range Ramp Factor	0.1	10.0		1.0	264	
P7.22	Power Loss Function				0	267	0 = Disabled 1 = Decel Mode 2 = Coast Mode
P7.23	Power Loss Time	0.3	5.0	s	2.0	268	
P7.24	Currency				0	2122	0 = \$ 1 = £ 2 = € 3 = ¥ 4 = Rs 5 = R\$ 6 = Fr 7 = kr
P7.25	Energy Cost			Varies	0.00	2123	
P7.26	Data Type				0	2124	0 = Cumulative 1 = Daily Avg 2 = Weekly Avg 3 = Monthly Avg 4 = Yearly Avg
P7.27	Energy Savings Reset					2125	0 = Not Reset 1 = Reset
P7.28 ①	2nd Stage Ramp Frequency	See Par ID 101	See Par ID 102	Hz	30.00	2444	
P7.29	Change PhaseSequence Motor				0	2515	0 = Change Disable 1 = Change Enable

**Note:** ① Parameter value can only be changed after the drive has stopped.  
 ② Parameter value will be set to be default when changing macros.  
 ③ Input function is level sensed.  
 ④ Input function is edge sensed.  
 ⑤ Input function is edge sensed when using StartP/StopP start logic.

## Chapter 8—Multi-purpose application

**Table 162. Drive Control—P7, continued**

Code	Parameter	Min.	Max.	Unit	Default	ID	Note
P7.30	Run Remove Stop Mode				0	2667	See Par ID 253

**Table 163. Motor control—P8.**

Code	Parameter	Min.	Max.	Unit	Default	ID	Note
P8.1 ①②	Motor Control Mode				0	287	0 = Freq Control 1 = Speed Control 5 = Open Loop Speed Control 6 = Open Loop Torque Control
P8.2 ③	Current Limit	DriveNomCurrCT*1/10	DriveNomCurrCT*2	A	DriveNomCurrVT	107	
P8.3 ④	V/Hz Optimization				0	109	See Par ID 2462
P8.4 ④	V/Hz Ratio				0	108	0 = Linear 1 = Squared 2 = Programmable 3 = Linear + Flux Optimization
P8.5 ④	Field Weakening Point	8.00	400.00	Hz	FieldWeakPointMFG	289	
P8.6 ④	Voltage at FWP	10.00	200.00	%	100.00	290	
P8.7 ④	V/Hz Mid Frequency	0.00	See Par ID 289	Hz	VHzCurveMidFreqMFG	291	
P8.8 ④	V/Hz Mid Voltage	0.00	100.00	%	100.00	292	
P8.9 ④	Zero Frequency Voltage	0.00	40.00	%	0.00	293	
P8.10	Switching Frequency	MinSwitchFreq	MaxSwitchFreq	kHz	DefaultSwitchFreqCT	2522	
P8.11	Sine Filter Enable				0	1665	See Par ID 2462
P8.12 ①	OverVoltage Control				3	294	0 = Disabled 1 = REF + 8Hz 2 = Max Freq 3 = Max Freq + 8Hz
P8.13	Load Drooping	0.00	100.00	%	0.00	298	
P8.14 ②	Identification				0	299	0 = No Action 1 = Identification Only Stator Resistor 2 = Identification with Run 3 = Identification No Run 4 = Identification Only Inertia
P8.15	Neg Frequency Limit	-400.00	See Par ID 1576	Hz	-400.00	1574	
P8.16	Pos Frequency Limit	See Par ID 1574	400.00	Hz	400.00	1576	
P8.17	Frequency Ramp Out FilterTime Constant	0	3000	ms	0	1585	
P8.18	Speed Error Filter Time Constant	0	3000	ms	0	1591	
P8.20	Speed Control Kp0	0.0	1000.0	%		1593	
P8.21	Speed Control Ti0	0.0	3200.0	ms		1594	
P8.24	Speed Control F0	0.00	See Par ID 1598	Hz	5.00	1597	
P8.25	Speed Control F1	See Par ID 1597	See Par ID 289	Hz	10.00	1598	
P8.26	Speed Control Kp1	0.0	1000.0	%		1599	
P8.27	Speed Control Ti1	0.0	3200.0	ms		1600	
P8.29	Motoring Torque Limit	0.0	300.0	%	300.0	1602	
P8.30	Generator Torque Limit	0.0	300.0	%	300.0	1603	
P8.31	Torque Limit Forward	0.0	300.0	%	300.0	1604	
P8.32	Torque Limit Reverse	0.0	300.0	%	300.0	1605	

- Note:** ① Parameter value can only be changed after the drive has stopped.  
 ② Parameter value will be set to be default when changing macros.  
 ③ Input function is level sensed.  
 ④ Input function is edge sensed.  
 ⑤ Input function is edge sensed when using StartP/StopP start logic.

**Table 163. Motor control—P8, continued.**

Code	Parameter	Min.	Max.	Unit	Default	ID	Note
P8.33	Motoring Power Limit	0.0	300.0	%	300.0	1607	
P8.34	Generator Power Limit	0.0	300.0	%	300.0	1608	
P8.35	Acc Compensation Time Constant	0.0	1000.0	%	0.0	1611	
P8.36	Acc Compensation Filter Time Constant	0	3000	ms	0	1612	
P8.37	Flux Reference	0.0	500.0	%	100.0	1620	
P8.43	Droop Control Filter Time Constant	0	3000	ms	0	1630	
P8.44	Startup Torque Selection				0	1631	0 = Not Used 1 = TorqueMemory 2 = Reserve 3 = StartupTorque FWD/REV
P8.45	Torque Memory Start	-300.0	300.0	%	0.0	1632	
P8.46	Startup Torque Forward	-300.0	300.0	%	0.0	1633	
P8.47	Startup Torque Reverse	-300.0	300.0	%	0.0	1634	
P8.48	Startup Torque Actual			%		1635	
P8.49	Startup Torque Time	0	10000	ms	50	1667	
P8.50 ①	Stator Resistor	0.001	65.535	ohm	0.033	771	
P8.51 ①	Rotor Resistor	0.001	65.535	ohm	0.034	772	
P8.52 ①	Leak Inductance	0.01	655.35	mh	0.12	773	
P8.53 ①	Mutual Inductance	0.1	6553.5	mh	3.4	774	
P8.54 ①	Excitation Current	0.0	DriveNomCurrCT*2	A	0.0	775	
P8.59	VF Stable Kd	0	3000	%	100	1656	
P8.60	VF Stable Kq	0	3000	%	100	1657	
P8.61 ①	Overmodulation Enable				0	2835	See Par ID 2462
P8.62 ①	Motor Inertia	0.001	65.535		0.038	2837	
P8.63 ①	PM BEMF Voltage	0.0	6553.5	V	0.1	1882	
P8.64 ①	PM q-axis Stator Inductance	0.00	655.35	mh	0.01	1883	
P8.65 ①	PM d-axis Stator Inductance	0.00	655.35	mh	0.01	1884	
P8.66 ①	PM Initial Selection				1	1890	0 = Align 1 = Six Pluse 2 = HFI
P8.67 ①	PM Initial Time	0.0	60.0	s	0.7	1891	
P8.68 ①	PM excited Current	0	200	%	20	1892	
P8.69 ①	PM excited Current Off Frequency	10.00	See Par ID 488	%	20.00	1893	
P8.70	Observer Kp	1	3000	%	100	2901	
P8.71	Slip Compensation Coefficient	0	500	%	100	1664	

**Table 164. Protections—P9.**

Code	Parameter	Min.	Max.	Unit	Default	ID	Note
P9.1 ①	4mA Input Fault				0	306	0 = No Action 1 = Warning 2 = Warning: Previous Freq 3 = Warning: Preset Freq 4 = Fault 5 = Fault, Coast
P9.2 ①	4mA Fault Frequency	0.00	See Par ID 102	Hz	0.00	331	

**Note:** ① Parameter value can only be changed after the drive has stopped.  
 ② Parameter value will be set to be default when changing macros.  
 ③ Input function is level sensed.  
 ④ Input function is edge sensed.  
 ⑤ Input function is edge sensed when using StartP/StopP start logic.

## Chapter 8—Multi-purpose application

**Table 164. Protections—P9, continued.**

Code	Parameter	Min.	Max.	Unit	Default	ID	Note
P9.3 ①	External Fault				2	307	0 = No Action 1 = Warning 2 = Fault 3 = Fault, Coast
P9.4 ①	Input Phase Fault				2	332	0 = No Action 1 = Warning 2 = Fault 3 = Fault, Coast 4 = Single Phase Power Limit
P9.5 ①	Uvolt Fault Response				2	330	See Par ID 307
P9.6 ①	Output Phase Fault				2	308	See Par ID 307
P9.7 ①	Ground Fault				2	309	See Par ID 307
P9.8 ①	Motor Thermal Protection				2	310	See Par ID 307
P9.9	Motor Thermal FO Current	0.0	150.0	%	100.0	311	
P9.11 ①	Stall Protection				0	313	See Par ID 307
P9.12	Stall Current Limit	0.1	ActiveMotor NomCurr*2	A	ActiveMotor NomCurr*13/10	314	
P9.13	Stall Time Limit	1.0	120.0	s	15.0	315	
P9.14	Stall Frequency Limit	1.00	See Par ID 102	Hz	25.00	316	
P9.15 ①	Underload Protection				0	317	See Par ID 307
P9.16	Underload Fnom Torque	10.0	150.0	%	50.0	318	
P9.17	Underload FO Torque	5.0	150.0	%	10.0	319	
P9.18	Underload Time Limit	2.00	600.00	s	20.00	320	
P9.19 ①	Thermistor Fault Response				2	333	See Par ID 307
P9.20	Line Start Lockout				2	750	0 = Disabled, No Change 1 = Enable, No Change 2 = Disabled, Changed 3 = Enable, Changed
P9.21 ①	Fieldbus Fault Response				2	334	0 = No Action 1 = Warning 2 = Fault 3 = Fault, Coast 4 = Warning, Coast 5 = Warning, Auto Switch To Local 6 = Warning, Auto Switch To Preset Speed 1
P9.22 ①	OPTCard Fault Response				2	335	See Par ID 307
P9.23 ①	Unit Under Temp Prot				2	1564	See Par ID 307
P9.24	AR Wait Time	1.00	300.00	s	1.00	321	
P9.25	AR Trail Time	0.00	600.00	s	30.00	322	
P9.26	AR Start Function				0	323	0 = Flying Start From Stop Frequency 1 = Ramp 2 = Flying Start From Max Frequency
P9.27	Undervoltage Attempts	0	10		1	324	
P9.28	OverVoltage Attempts	0	10		1	325	
P9.29	OverCurrent Attempts	0	3		1	326	
P9.30	4mA Fault Attempts	0	10		1	327	
P9.31	Motor Temp Fault Attempts	0	10		1	329	
P9.32	External Fault Attempts	0	10		1	328	
P9.33	Underload Attempts	0	10		1	336	

- Note:**
- ① Parameter value can only be changed after the drive has stopped.
  - ② Parameter value will be set to be default when changing macros.
  - ③ Input function is level sensed.
  - ④ Input function is edge sensed.
  - ⑤ Input function is edge sensed when using StartP/StopP start logic.

**Table 164. Protections—P9, continued.**

<b>Code</b>	<b>Parameter</b>	<b>Min.</b>	<b>Max.</b>	<b>Unit</b>	<b>Default</b>	<b>ID</b>	<b>Note</b>
P9.34 ①	RTC Fault				1	955	See Par ID 307
P9.35 ①	PT100 Fault Response				2	337	See Par ID 307
P9.36 ①	Replace Battery Fault Response				1	1256	See Par ID 307
P9.37 ①	Replace Fan Fault Response				1	1257	See Par ID 307
P9.38 ①	IP Address Conflicion Resp				1	1678	See Par ID 307
P9.39	Cold Weather Mode				0	2126	See Par ID 2462
P9.40	Cold Weather Volt. Level	0.0	20.0	%	2.0	2127	
P9.41	Cold Weather Time Out	0	10	min	3	2128	
P9.42	Cold Weather Password					2129	
P9.43	Under Temp Fault Override					2130	See Par ID 2118
P9.44	Ground Fault Limit	0	30	%	15	2158	
P9.45 ①	Keypad Comm Fault Response				2	2157	See Par ID 307
P9.46	Preheat Mode				0	2159	See Par ID 2462

**Note:** ① Parameter value can only be changed after the drive has stopped.  
 ② Parameter value will be set to be default when changing macros.  
 ③ Input function is level sensed.  
 ④ Input function is edge sensed.  
 ⑤ Input function is edge sensed when using StartP/StopP start logic.

## Chapter 8—Multi-purpose application

**Table 164. Protections—P9, continued.**

Code	Parameter	Min.	Max.	Unit	Default	ID	Note
P9.47 ②	Preheat Control Source				31	2160	0 = DigIN:NormallyOpen 1 = DigIN:NormallyClose 2 = DigIN: 1 3 = DigIN: 2 4 = DigIN: 3 5 = DigIN: 4 6 = DigIN: 5 7 = DigIN: 6 8 = DigIN: 7 9 = DigIN: 8 10 = DigIN: A: IO1: 1 11 = DigIN: A: IO1: 2 12 = DigIN: A: IO1: 3 13 = DigIN: A: IO5: 1 14 = DigIN: A: IO5: 2 15 = DigIN: A: IO5: 3 16 = DigIN: A: IO5: 4 17 = DigIN: A: IO5: 5 18 = DigIN: A: IO5: 6 19 = DigIN: B: IO1: 1 20 = DigIN: B: IO1: 2 21 = DigIN: B: IO1: 3 22 = DigIN: B: IO5: 1 23 = DigIN: B: IO5: 2 24 = DigIN: B: IO5: 3 25 = DigIN: B: IO5: 4 26 = DigIN: B: IO5: 5 27 = DigIN: B: IO5: 6 28 = Time Channel 1 29 = Time Channel 2 30 = Time Channel 3 31 = Drive Temperature 32 = SlotA PT100 Temp Channel 1 33 = SlotA PT100 Temp Channel 2 34 = SlotA PT100 Temp Channel 3 35 = SlotA Max PT100 Temp 36 = SlotB PT100 Temp Channel 1 37 = SlotB PT100 Temp Channel 2 38 = SlotB PT100 Temp Channel 3 39 = SlotB Max PT100 Temp 40 = SlotA and SlotB Max PT100 Temp
P9.48	Preheat Enter Temp	-20.0	20.0	Deg. C	10.0	2161	
P9.49	Preheat Quit Temp	-10.0	40.0	Deg. C	20.0	2162	
P9.50	Preheat Output Volt	0.0	20.0	%	2.0	2163	
P9.51 ①	PID Feedback AI Loss Response				0	2401	0 = No Action 1 = Warning 2 = Fault 3 = Warning: Preset Freq 4 = Warning: Analog->Net
P9.52 ①	PID Feedback AI Loss Pre Freq	0.00	400.00	Hz	0.00	2402	
P9.53	PID Feedback AI Loss Pipe Fill Loss Level	0.0	1000.0	Varies	0.0	2403	
P9.54	PID Feedback AI Loss PreFreq Timeout	0	6000	s	0	2404	

- Note:**
- ① Parameter value can only be changed after the drive has stopped.
  - ② Parameter value will be set to be default when changing macros.
  - ③ Input function is level sensed.
  - ④ Input function is edge sensed.
  - ⑤ Input function is edge sensed when using StartP/StopP start logic.

**Table 164. Protections—P9, continued.**

Code	Parameter	Min.	Max.	Unit	Default	ID	Note
P9.55	PID Feedback AI Loss Attempts	0	10		1	2405	
P9.56	STO Fault Response				2	2427	0 = No Action 1 = Warning 2 = Fault
P9.57	Fault Reset Start				0	2483	0 = Follow Run Command 1 = Rising Edge After Fault Reset
P9.58	Warning Operation Mode				1	2657	0 = No Action 1 = Warning, No Store 2 = Warning, Store
P9.59	Fan Protection				2	2664	See Par ID 307
P9.60	Under Voltage Trip Level	DCLinkUnderVolt StopLimit	DCLinkOverVolt StopLimit	V	DCLinkUnderVolt ProtectLimit	2666	
P9.61	OP Cont Interlock Attempts	0	10		1	2803	
P9.62 ①	OP Cont Interlock Protection				2	2831	See Par ID 307
P9.63 ①	CP Interlock Run Protection				2	2895	See Par ID 307
P9.64 ①	CP Interlock Stop Protection				1	2896	0 = No Action 1 = Warning, No Store
P9.65	CP Interlock Attempts	0	10		1	2897	

**Table 165. PID controller 1—P10.**

Code	Parameter	Min.	Max.	Unit	Default	ID	Note
P10.1	PID1 Control Gain	0.00	200.00	%	100.00	1294	
P10.2	PID1 Control ITime	0.00	600.00	s	1.00	1295	
P10.3	PID1 Control DTime	0.00	100.00	s	0.00	1296	

**Note:** ① Parameter value can only be changed after the drive has stopped.  
 ② Parameter value will be set to be default when changing macros.  
 ③ Input function is level sensed.  
 ④ Input function is edge sensed.  
 ⑤ Input function is edge sensed when using StartP/StopP start logic.

## Chapter 8—Multi-purpose application

**Table 165. PID controller 1—P10, continued.**

Code	Parameter	Min.	Max.	Unit	Default	ID	Note
P10.4 ①, continued	PID1 Process Unit				0	1297	0 = % 1 = 1/min 2 = rpm 3 = ppm 4 = pps 5 = l/s 6 = l/min 7 = l/h 8 = kg/s 9 = kg/min 10 = kg/h 11 = m3/s 12 = m3/min 13 = m3/h 14 = m/s 15 = mbar 16 = bar 17 = Pa 18 = kPa 19 = mVS 20 = kW 21 = Deg. C 22 = GPM 23 = gal/s 24 = gal/min 25 = gal/h 26 = lb/s 27 = lb/min 28 = lb/h 29 = CFM 30 = ft3/s 31 = ft3/min 32 = ft3/h 33 = ft/s 34 = in wg 35 = ft wg 36 = PSI 37 = lb/in2 38 = HP 39 = Deg. F 40 = PA 41 = WC 42 = HG 43 = ft 44 = m
P10.5	PID1 Process Unit Min	-99999.99	See Par ID 1300	Varies	0.00	1298	
P10.6	PID1 Process Unit Max	See Par ID 1298	99999.99	Varies	100.00	1300	
P10.7	PID1 Process Unit Decimal	0	4		2	1302	
P10.8 ①	PID1 Error Inversion				0	1303	See Par ID 181
P10.9	PID1 Dead Band	0.00	99999.99	Varies	0.00	1304	
P10.10	PID1 Dead Band Delay	0.00	320.00	s	0.00	1306	
P10.11	PID1 Keypad Set Point 1	See Par ID 1298	See Par ID 1300	Varies	0.00	1307	
P10.12	PID1 Keypad Set Point 2	See Par ID 1298	See Par ID 1300	Varies	0.00	1309	
P10.13	PID1 Ramp Time	0.00	300.00	s	0.00	1311	

- Note:** ① Parameter value can only be changed after the drive has stopped.  
 ② Parameter value will be set to be default when changing macros.  
 ③ Input function is level sensed.  
 ④ Input function is edge sensed.  
 ⑤ Input function is edge sensed when using StartP/StopP start logic.



**Table 165. PID controller 1—P10, continued.**

Code	Parameter	Min.	Max.	Unit	Default	ID	Note
P10.14 ①②	PID1 Set Point 1 Source				1	1312	0 = Not Used 1 = PID1 Keypad Set Point 1 2 = PID1 Keypad Set Point 2 3 = AI1 4 = AI2 5 = Slot A: AI1 6 = Slot B: AI1 7 = FB Process Data Input 1 8 = FB Process Data Input 2 9 = FB Process Data Input 3 10 = FB Process Data Input 4 11 = FB Process Data Input 5 12 = FB Process Data Input 6 13 = FB Process Data Input 7 14 = FB Process Data Input 8 15 = PID2 Output 16 = Multi Drive Network 17 = FB PID1 Set Point 1 18 = FB PID1 Set Point 2
P10.15	PID1 Set Point 1 Min	-200.00	200.00	%	0.00	1313	
P10.16	PID1 Set Point 1 Max	-200.00	200.00	%	100.00	1314	
P10.17 ③	PID1 Set Point 1 Sleep Enable				0	1315	See Par ID 2462
P10.18 ④	PID1 Set Point 1 Sleep Unit Sel				0	2396	0 = Output Frequency 1 = Motor Speed 2 = Motor Current 3 = PID1 Feedback
P10.19	PID1 Set Point 1 Sleep Level			Varies	0.00	2450	
P10.20	PID1 Set Point 1 Sleep Delay	0	3000	s	0	1317	
P10.21	PID1 Set Point 1 Wake Up Level	-99999.99	99999.99	Varies	0.00	1318	
P10.22	PID1 Set Point 1 Boost	-2.0	2.0		1.0	1320	
P10.23 ①②	PID1 Set Point 2 Source				2	1321	See Par ID 1312
P10.24	PID1 Set Point 2 Min	-200.00	200.00	%	0.00	1322	
P10.25	PID1 Set Point 2 Max	-200.00	200.00	%	100.00	1323	
P10.26 ③	PID1 Set Point 2 Sleep Enable				0	1324	See Par ID 2462
P10.27 ④	PID1 Set Point 2 Sleep Unit Sel				0	2397	See Par ID 2396
P10.28	PID1 Set Point 2 Sleep Level			Varies	0.00	2452	
P10.29	PID1 Set Point 2 Sleep Delay	0	3000	s	0	1326	
P10.30	PID1 Set Point 2 Wake Up Level	-99999.99	99999.99	Varies	0.00	1327	
P10.31	PID1 Set Point 2 Boost	-2.0	2.0		1.0	1329	

**Note:** ① Parameter value can only be changed after the drive has stopped.  
 ② Parameter value will be set to be default when changing macros.  
 ③ Input function is level sensed.  
 ④ Input function is edge sensed.  
 ⑤ Input function is edge sensed when using StartP/StopP start logic.

## Chapter 8—Multi-purpose application

**Table 165. PID controller 1—P10, continued.**

Code	Parameter	Min.	Max.	Unit	Default	ID	Note
P10.32 ①	PID1 Feedback Function				0	1330	0 = Source 1 1 = SQRT(Source 1) 2 = SQRT(Source 1 - Source 2) 3 = SQRT(Source 1) + SQRT(Source 2) 4 = Source 1 + Source 2 5 = Source 1 - Source 2 6 = MIN(Source 1, Source 2) 7 = MAX(Source 1, Source 2) 8 = MEAN(Source1, Source2) 9 = Source1*Source2
P10.33	PID1 Feedback Gain	-1000.0	1000.0	%	100.0	1331	
P10.34 ①②	PID1 Feedback 1 Source				2	1332	0 = Not Used 1 = AI1 2 = AI2 3 = Slot A: AI1 4 = Slot B: AI1 5 = FB Process Data Input 1 6 = FB Process Data Input 2 7 = FB Process Data Input 3 8 = FB Process Data Input 4 9 = FB Process Data Input 5 10 = FB Process Data Input 6 11 = FB Process Data Input 7 12 = FB Process Data Input 8 13 = PT100 Temperature 14 = PID2 Output 15 = SlotA PT100 Temp Channel 1 16 = SlotA PT100 Temp Channel 2 17 = SlotA PT100 Temp Channel 3 18 = SlotB PT100 Temp Channel 1 19 = SlotB PT100 Temp Channel 2 20 = SlotB PT100 Temp Channel 3 21 = FB PID1 Feedback 1 22 = FB PID1 Feedback 2
P10.35	PID1 Feedback 1 Min	-200.00	200.00	%	0.00	1333	
P10.36	PID1 Feedback 1 Max	-200.00	200.00	%	100.00	1334	
P10.37 ①②	PID1 Feedback 2 Source				0	1335	See Par ID 1332
P10.38	PID1 Feedback 2 Min	-200.00	200.00	%	0.00	1336	
P10.39	PID1 Feedback 2 Max	-200.00	200.00	%	100.00	1337	
P10.40 ①	PID1 Feedforward Func				0	1338	See Par ID 1330
P10.41	PID1 Feedforward Gain	-1000.0	1000.0	%	100.0	1339	

- Note:**
- ① Parameter value can only be changed after the drive has stopped.
  - ② Parameter value will be set to be default when changing macros.
  - ③ Input function is level sensed.
  - ④ Input function is edge sensed.
  - ⑤ Input function is edge sensed when using StartP/StopP start logic.

**Table 165. PID controller 1—P10, continued.**

Code	Parameter	Min.	Max.	Unit	Default	ID	Note
P10.42 ①②	PID1 Feedforward 1 Source				0	1340	0 = Not Used 1 = AI1 2 = AI2 3 = Slot A: AI1 4 = Slot B: AI1 5 = FB Process Data Input 1 6 = FB Process Data Input 2 7 = FB Process Data Input 3 8 = FB Process Data Input 4 9 = FB Process Data Input 5 10 = FB Process Data Input 6 11 = FB Process Data Input 7 12 = FB Process Data Input 8 13 = PT100 Temperature 14 = PID2 Output 15 = SlotA PT100 Temp Channel 1 16 = SlotA PT100 Temp Channel 2 17 = SlotA PT100 Temp Channel 3 18 = SlotB PT100 Temp Channel 1 19 = SlotB PT100 Temp Channel 2 20 = SlotB PT100 Temp Channel 3 21 = FB PID1 Feedforward 1 22 = FB PID1 Feedforward 2
P10.43	PID1 Feedforward 1 Min	-200.00	200.00	%	0.00	1341	
P10.44	PID1 Feedforward 1 Max	-200.00	200.00	%	100.00	1342	
P10.45 ①②	PID1 Feedforward 2 Source				0	1343	See Par ID 1340
P10.46	PID1 Feedforward 2 Min	-200.00	200.00	%	0.00	1344	
P10.47	PID1 Feedforward 2 Max	-200.00	200.00	%	100.00	1345	
P10.48	PID1 Set Point 1 Comp Enable				0	1352	See Par ID 2462
P10.49	PID1 Set Point 1 Comp Max	-200.00	200.00	%	0.00	1353	
P10.50	PID1 Set Point 2 Comp Enable				0	1354	See Par ID 2462
P10.51	PID1 Set Point 2 Comp Max	-200.00	200.00	%	0.00	1355	
P10.52	PID1 Wake Up Action				0	2466	0 = Below Wake Up Level 1 = Above Wake Up Level 2 = Below Wake Up Level(PID ref.) 3 = Above Wake Up Level(PID ref.)
P10.53	FB PID1 Set Point 1	See Par ID 1298	See Par ID 1300	Varies		2542	
P10.54	FB PID1 Set Point 2	See Par ID 1298	See Par ID 1300	Varies		2544	
P10.55	FB PID1 Feedback 1			%		2550	

**Note:** ① Parameter value can only be changed after the drive has stopped.  
 ② Parameter value will be set to be default when changing macros.  
 ③ Input function is level sensed.  
 ④ Input function is edge sensed.  
 ⑤ Input function is edge sensed when using StartP/StopP start logic.

## Chapter 8—Multi-purpose application

**Table 165. PID controller 1—P10, continued.**

Code	Parameter	Min.	Max.	Unit	Default	ID	Note
P10.56	FB PID1 Feedback 2			%		2551	
P10.57	FB PID1 Feedforward 1			%		2554	
P10.58	FB PID1 Feedforward 2			%		2555	
P10.59	PID1 Sleep Boost level	-9999	9999	Varies	0	2660	
P10.60	PID1 Sleep Boost Max Time	1	300	s	30	2661	
P10.61	PID1 Low Feedback Level	0.0	6000.0	Varies	0.0	2811	
P10.62	PID1 Low Feedback Time	0	3600	s	10	2812	
P10.63 ①	PID1 Low Feedback Protection				0	2813	See Par ID 307
P10.64	PID1 High Feedback Level	0.0	6000.0	Varies	150.0	2814	
P10.65	PID1 High Feedback Time	0	3600	s	5	2815	
P10.66 ①	PID1 High Feedback Protection				0	2816	See Par ID 307
P10.67 ①	PID1 Hysteresis Level	0.0	100.0	Varies	0.0	2817	
P10.68	PID1 Backup Feedback Source				0	2825	0 = Not Used 1 = AI1 2 = AI2 3 = Slot A: AI1 4 = Slot B: AI1

- Note:** ① Parameter value can only be changed after the drive has stopped.  
 ② Parameter value will be set to be default when changing macros.  
 ③ Input function is level sensed.  
 ④ Input function is edge sensed.  
 ⑤ Input function is edge sensed when using StartP/StopP start logic.

**Table 166. PID controller 2—P11.**

Code	Parameter	Min.	Max.	Unit	Default	ID	Note
P11.1	PID2 Control Gain	0.00	200.00	%	100.00	1356	
P11.2	PID2 Control I Time	0.00	600.00	s	1.00	1357	
P11.3	PID2 Control D Time	0.00	100.00	s	0.00	1358	
P11.4 ①	PID2 Process Unit				0	1359	See Par ID 1297
P11.5	PID2 Process Unit Min	-99999.99	See Par ID 1362	Varies	0.00	1360	
P11.6	PID2 Process Unit Max	See Par ID 1360	99999.99	Varies	100.00	1362	
P11.7	PID2 Process Unit Decimal	0	4		2	1364	
P11.8 ①	PID2 Error Inversion				0	1365	See Par ID 181
P11.9	PID2 Dead Band	0.00	99999.99	Varies	0.00	1366	
P11.10	PID2 Dead Band Delay	0.00	320.00	s	0.00	1368	
P11.11	PID2 Keypad Set Point 1	See Par ID 1360	See Par ID 1362	Varies	0.00	1369	
P11.12	PID2 Keypad Set Point 2	See Par ID 1360	See Par ID 1362	Varies	0.00	1371	
P11.13	PID2 Ramp Time	0.00	300.00	s	0.00	1373	
P11.14 ①	PID2 Set Point 1 Source				1	1374	0 = Not Used 1 = PID2 Keypad Set Point 1 2 = PID2 Keypad Set Point 2 3 = AI1 4 = AI2 5 = Slot A: AI1 6 = Slot B: AI1 7 = FB Process Data Input 1 8 = FB Process Data Input 2 9 = FB Process Data Input 3 10 = FB Process Data Input 4 11 = FB Process Data Input 5 12 = FB Process Data Input 6 13 = FB Process Data Input 7 14 = FB Process Data Input 8 15 = PID1 Output 16 = Multi Drive Network 17 = FB PID2 Set Point 1 18 = FB PID2 Set Point 2
P11.15	PID2 Set Point 1 Min	-200.00	200.00	%	0.00	1375	
P11.16	PID2 Set Point 1 Max	-200.00	200.00	%	100.00	1376	
P11.17 ①	PID2 Set Point 1 Sleep Enable				0	1377	See Par ID 2462
P11.18 ①	PID2 Set Point 1 Sleep Unit Sel				0	2398	0 = Output Frequency 1 = Motor Speed 2 = Motor Current 3 = PID2 Feedback
P11.19	PID2 Set Point 1 Sleep Level			Varies	0.00	2454	
P11.20	PID2 Set Point 1 Sleep Delay	0	3000	s	0	1379	
P11.21	PID2 Set Point 1 WakeUp Level	-99999.99	99999.99	Varies	0.00	1380	
P11.22	PID2 Set Point 1 Boost	-2.0	2.0		1.0	1382	
P11.23 ①	PID2 Set Point 2 Source				2	1383	See Par ID 1374
P11.24	PID2 Set Point 2 Min	-200.00	200.00	%	0.00	1384	

**Note:** ① Parameter value can only be changed after the drive has stopped.  
 ② Parameter value will be set to be default when changing macros.  
 ③ Input function is level sensed.  
 ④ Input function is edge sensed.  
 ⑤ Input function is edge sensed when using StartP/StopP start logic.

## Chapter 8—Multi-purpose application

**Table 166. PID controller 2—P11, continued.**

Code	Parameter	Min.	Max.	Unit	Default	ID	Note
P11.25	PID2 Set Point 2 Max	-200.00	200.00	%	100.00	1385	
P11.26 ①	PID2 Set Point 2 Sleep Enable				0	1386	See Par ID 2462
P11.27 ①	PID2 Set Point 2 Sleep Unit Sel				0	2399	See Par ID 2398
P11.28	PID2 Set Point 2 Sleep Level			Varies	0.00	2456	
P11.29	PID2 Set Point 2 Sleep Delay	0	3000	s	0	1388	
P11.30	PID2 Set Point 2 WakeUp Level	-99999.99	99999.99	Varies	0.00	1389	
P11.31	PID2 Set Point 2 Boost	-2.0	2.0		1.0	1391	
P11.32 ①	PID2 Feedback Func				0	1392	See Par ID 1330
P11.33	PID2 Feedback Gain	-1000.0	1000.0	%	100.0	1393	
P11.34 ①	PID2 Feedback 1 Source				2	1394	0 = Not Used 1 = AI1 2 = AI2 3 = Slot A: AI1 4 = Slot B: AI1 5 = FB Process Data Input 1 6 = FB Process Data Input 2 7 = FB Process Data Input 3 8 = FB Process Data Input 4 9 = FB Process Data Input 5 10 = FB Process Data Input 6 11 = FB Process Data Input 7 12 = FB Process Data Input 8 13 = PT100 Temperature 14 = PID1 Output 15 = SlotA PT100 Temp Channel 1 16 = SlotA PT100 Temp Channel 2 17 = SlotA PT100 Temp Channel 3 18 = SlotB PT100 Temp Channel 1 19 = SlotB PT100 Temp Channel 2 20 = SlotB PT100 Temp Channel 3 21 = FB PID2 Feedback 1 22 = FB PID2 Feedback 2
P11.35	PID2 Feedback 1 Min	-200.00	200.00	%	0.00	1395	
P11.36	PID2 Feedback 1 Max	-200.00	200.00	%	100.00	1396	
P11.37 ①	PID2 Feedback 2 Source				0	1397	See Par ID 1394
P11.38	PID2 Feedback 2 Min	-200.00	200.00	%	0.00	1398	
P11.39	PID2 Feedback 2 Max	-200.00	200.00	%	100.00	1399	
P11.40 ①	PID2 Feedforward Func				0	1400	See Par ID 1330
P11.41	PID2 Feedforward Gain	-1000.0	1000.0	%	100.0	1401	

- Note:**
- ① Parameter value can only be changed after the drive has stopped.
  - ② Parameter value will be set to be default when changing macros.
  - ③ Input function is level sensed.
  - ④ Input function is edge sensed.
  - ⑤ Input function is edge sensed when using StartP/StopP start logic.

**Table 166. PID controller 2—P11, continued.**

Code	Parameter	Min.	Max.	Unit	Default	ID	Note
P11.42 ①	PID2 Feedforward 1 Source				0	1402	0 = Not Used 1 = AI1 2 = AI2 3 = Slot A: AI1 4 = Slot B: AI1 5 = FB Process Data Input 1 6 = FB Process Data Input 2 7 = FB Process Data Input 3 8 = FB Process Data Input 4 9 = FB Process Data Input 5 10 = FB Process Data Input 6 11 = FB Process Data Input 7 12 = FB Process Data Input 8 13 = PT100 Temperature 14 = PID1 Output 15 = SlotA PT100 Temp Channel 1 16 = SlotA PT100 Temp Channel 2 17 = SlotA PT100 Temp Channel 3 18 = SlotB PT100 Temp Channel 1 19 = SlotB PT100 Temp Channel 2 20 = SlotB PT100 Temp Channel 3 21 = FB PID2 Feedforward 1 22 = FB PID2 Feedforward 2
P11.43	PID2 Feedforward 1 Min	-200.00	200.00	%	0.00	1403	
P11.44	PID2 Feedforward 1 Max	-200.00	200.00	%	100.00	1404	
P11.45 ②	PID2 Feedforward 2 Source				0	1405	See Par ID 1402
P11.46	PID2 Feedforward 2 Min	-200.00	200.00	%	0.00	1406	
P11.47	PID2 Feedforward 2 Max	-200.00	200.00	%	100.00	1407	
P11.48	PID2 Set Point1 Comp Enable				0	1414	See Par ID 2462
P11.49	PID2 Set Point1 Comp Max	-200.00	200.00	%	0.00	1415	
P11.50	PID2 Set Point 2 Comp Enable				0	1416	See Par ID 2462
P11.51	PID2 Set Point 2 Comp Max	-200.00	200.00	%	0.00	1417	
P11.52	PID2 Wake Up Action				0	2467	See Par ID 2466
P11.53	FB PID2 Set Point 1	See Par ID 1298	See Par ID 1300	Varies		2546	
P11.54	FB PID2 Set Point 2	See Par ID 1298	See Par ID 1300	Varies		2548	
P11.55	FB PID2 Feedback 1			%		2552	
P11.56	FB PID2 Feedback 2			%		2553	
P11.57	FB PID2 Feedforward 1			%		2556	
P11.58	FB PID2 Feedforward 2			%		2557	
P11.59	PID2 Sleep Boost level	-9999	9999	Varies	0	2662	

**Note:** ① Parameter value can only be changed after the drive has stopped.  
 ② Parameter value will be set to be default when changing macros.  
 ③ Input function is level sensed.  
 ④ Input function is edge sensed.  
 ⑤ Input function is edge sensed when using StartP/StopP start logic.

## Chapter 8—Multi-purpose application

**Table 166. PID controller 2—P11, continued.**

Code	Parameter	Min.	Max.	Unit	Default	ID	Note
P11.60	PID2 Sleep Boost Max Time	1	300	s	30	2663	
P11.61	PID2 Low Feedback Level	0.0	6000.0	Varies	0.0	2818	
P11.62	PID2 Low Feedback Time	0	3600	s	10	2819	
P11.63 ①	PID2 Low Feedback Protection				0	2820	See Par ID 307
P11.64	PID2 High Feedback Level	0.0	6000.0	Varies	150.0	2821	
P11.65	PID2 High Feedback Time	0	3600	s	5	2822	
P11.66 ②	PID2 High Feedback Protection				0	2823	See Par ID 307
P11.67 ③	PID2 Hysteresis Level	0.0	100.0	Varies	0.0	2824	
P11.68	PID2 Backup Feedback Source				0	2826	See Par ID 2825

**Table 167. Preset speed—P12.**

Code	Parameter	Min.	Max.	Unit	Default	ID	Note
P12.1	Preset Speed 1	0.00	See Par ID 102	Hz	5.00	105	
P12.2	Preset Speed 2	0.00	See Par ID 102	Hz	10.00	106	
P12.3	Preset Speed 3	0.00	See Par ID 102	Hz	15.00	118	
P12.4	Preset Speed 4	0.00	See Par ID 102	Hz	20.00	119	
P12.5	Preset Speed 5	0.00	See Par ID 102	Hz	25.00	120	
P12.6	Preset Speed 6	0.00	See Par ID 102	Hz	30.00	121	
P12.7	Preset Speed 7	0.00	See Par ID 102	Hz	35.00	122	

**Table 168. Torque control—P13.**

Code	Parameter	Min.	Max.	Unit	Default	ID	Note
P13.1	Torque Limit	0.0	400.0	%	400.0	295	
P13.2	Torque Ref Select				0	303	0 = Not Used 1 = AI1 2 = AI2 3 = Slot A: AI1 4 = Slot B: AI1 5 = AI1 Joystick 6 = AI2 Joystick 7 = Keypad Torque Ref 8 = FB Process Data Input 1 9 = PID1 Control Output 10 = PID2 Control Output 11 = FB Torque Ref
P13.3	Keypad Torque Ref	-300.0	300.0	%	0.0	782	
P13.4	Torque Ref Max	-300.0	300.0	%	100.0	304	
P13.5	Torque Ref Min	-300.0	300.0	%	0.0	305	

- Note:**
- ① Parameter value can only be changed after the drive has stopped.
  - ② Parameter value will be set to be default when changing macros.
  - ③ Input function is level sensed.
  - ④ Input function is edge sensed.
  - ⑤ Input function is edge sensed when using StartP/StopP start logic.



**Table 168. Torque control—P13, continued.**

Code	Parameter	Min.	Max.	Unit	Default	ID	Note
P13.6	Speed Limiter Mode				0	1666	0 = NegFreqMax ... PosFreqMax 1 = - FreqRampOut  ... + FreqRampOut  2 = NegFreqMax ... FreqRampout(MIN) 3 = FreqRampOut ... PosFreqMax(MAX) 4 = FreqRampOut ± WindowPos/NegWidth 5 = 0 ... FreqRampOut(pos or neg direction) 6 = FreqRamp ± WindowPos/Neg/PosOff/ NegOff
P13.7	Window Pos Width	0.00	50.00	Hz	2.00	1636	
P13.8	Window Neg Width	0.00	50.00	Hz	2.00	1637	
P13.9	Window Pos Off Limit	0.00	See Par ID 1636	Hz	0.00	1638	
P13.10	Window Neg Off Limit	0.00	See Par ID 1637	Hz	0.00	1639	
P13.11	Torque Reference Filter TC	0	32000	ms	0	1640	
P13.12	Pull Out Torque	0.0	1000.0	%	250.0	1606	
P13.13 ①	Stop State Magnetisation Time	0	32000	s	0	1684	
P13.14	FB Torque Ref	-300.0	300.0	%		2541	

**Table 169. Brake—P14.**

Code	Parameter	Min.	Max.	Unit	Default	ID	Note
P14.1 ①	DC-Brake Current	Drive NomCurrCT*15/100	Drive NomCurrCT*15/10	A	DriveNomCurrCT*1/2	254	
P14.2 ①	Start DC-Brake Time	0.00	600.00	s	0.00	263	
P14.3 ①	Stop DC-Brake Frequency	0.10	10.00	Hz	1.50	262	
P14.4 ①	Stop DC-Brake Time	0.00	600.00	s	0.00	255	
P14.5 ①	Brake Chopper Mode				0	251	0 = Disabled 1 = B(Run) T(Rdy) 2 = External 3 = B(Rdy) T(Rdy) 4 = B(Run) T(No)
P14.6 ①	Flux Brake				0	266	0 = Off 1 = On
P14.7 ①	Flux Brake Current	ActiveMotor NomCurr*1/10	See Par ID 107	A	ActiveMotorNomCurr*1/2	265	

**Note:** ① Parameter value can only be changed after the drive has stopped.  
 ② Parameter value will be set to be default when changing macros.  
 ③ Input function is level sensed.  
 ④ Input function is edge sensed.  
 ⑤ Input function is edge sensed when using StartP/StopP start logic.

## Chapter 8—Multi-purpose application

**Table 170. Fire mode—P15.**

Code	Parameter	Min.	Max.	Unit	Default	ID	Note
P15.1 ①	Fire Mode Function				0	535	0 = Closing Contact 1 = Opening Contact
P15.2 ①②	Fire Mode Ref Select Function				0	536	0 = Fire Mode Min Frequency 1 = Fire Mode Ref 2 = Fieldbus Ref 3 = AI1 4 = AI2 5 = AI1 + AI2 6 = PID1 Control Output 7 = PID2 Control Output
P15.3	Fire Mode Frequency	See Par ID 101	See Par ID 102	Hz	MotorNomFreqMFG	537	
P15.4	Fire Mode % Speed Ref 1	0.0	100.0	%	75.0	565	
P15.5	Fire Mode % Speed Ref 2	0.0	100.0	%	100.0	564	
P15.6 ①	Smoke Purge Frequency	0.0	100.0	%	50.0	554	
P15.7	Fire Mode Test Enable					2443	See Par ID 2462

**Table 171. Second motor parameter—P16.**

Code	Parameter	Min.	Max.	Unit	Default	ID	Note
P16.1 ①	Motor Nom Current 2	DriveNomCurrCT*1/10	DriveNomCurrCT*2	A	DriveNomCurrCT	577	
P16.2 ①	Motor Nom Speed 2	300	20000	rpm	SecdMotorNomSpeedMFG	578	
P16.3 ①	Motor PF 2	0.30	1.00		0.85	579	
P16.4 ①	Motor Nom Volt 2	180	690	V	SecdMotorNomVoltMFG	580	
P16.5 ①	Motor Nom Freq 2	8.00	400.00	Hz	SecdMotorNomFreqMFG	581	
P16.6 ①	Stator Resistor 2	0.001	65.535	ohm	0.033	1419	
P16.7 ①	Rotor Resistor 2	0.001	65.535	ohm	0.034	1420	
P16.8 ①	Leak Inductance 2	0.01	655.35	mh	0.12	1421	
P16.9 ①	Mutual Inductance 2	0.1	6553.5	mh	3.4	1422	
P16.10 ①	Excitation Current 2	0.0	DriveNomCurrCT*2	A	0.0	1423	
P16.11 ①	Motor Inertia2	0.001	65.535		0.100	2838	
P16.12 ①	Second PM BEMF Voltage	0.0	6553.5	V	0.1	2842	
P16.13 ①	Second PM q-axis Stator Inductance	0.00	655.35	mh	0.01	2843	
P16.14 ①	Second PM d-axis Stator Inductance	0.00	655.35	mh	0.01	2844	

- Note:**
- ① Parameter value can only be changed after the drive has stopped.
  - ② Parameter value will be set to be default when changing macros.
  - ③ Input function is level sensed.
  - ④ Input function is edge sensed.
  - ⑤ Input function is edge sensed when using StartP/StopP start logic.

## Bypass

**Table 172. Basic setting—P17.1.**

Code	Parameter	Min.	Max.	Unit	Default	ID	Note
P17.1.1 ①	Bypass Enable				0	1418	See Par ID 2462
P17.1.2 ①	Bypass Start Delay	1	32765	s	5	544	
P17.1.3 ①	Auto Bypass				0	542	See Par ID 2462
P17.1.4 ①	Auto Bypass Delay	0	32765	s	10	543	
P17.1.5 ①	OverCurrent Bypass Enable				0	547	See Par ID 2462
P17.1.6 ①	IGBT Fault Bypass Enable				0	546	See Par ID 2462
P17.1.7 ①	4mA Fault Bypass Enable				0	548	See Par ID 2462
P17.1.8 ①	UnderVoltage Bypass Enable				0	545	See Par ID 2462
P17.1.9 ①	OverVoltage Bypass Enable				0	549	See Par ID 2462
P17.1.10 ①	Motor OverTemp Bypass Enable				0	1698	See Par ID 2462
P17.1.11 ①	UnderLoad Bypass Enable				0	1699	See Par ID 2462
P17.1.12 ①	External Bypass Enable				0	1700	See Par ID 2462
P17.1.13 ①	Charge Switch Fault Bypass Enable				0	1701	See Par ID 2462
P17.1.14 ①	Saturation Trip Fault Bypass Enable				0	1702	See Par ID 2462
P17.1.15 ①	Under Temp Fault Bypass Enable				0	1703	See Par ID 2462
P17.1.16 ①	EEPROM Fault Bypass Enable				0	1704	See Par ID 2462
P17.1.17 ①	Control board EEPROM Fault Bypass Enable				0	1705	See Par ID 2462
P17.1.18 ①	Watchdog Fault Bypass Enable				0	1706	See Par ID 2462
P17.1.19 ①	Fan Cooling Fault Bypass Enable				0	1707	See Par ID 2462
P17.1.20 ①	Keypad Com Fault Bypass Enable				0	1708	See Par ID 2462
P17.1.21 ①	Option Card Fault Bypass Enable				0	1709	See Par ID 2462
P17.1.22 ①	RTC Clock Fault Bypass Enable				0	1710	See Par ID 2462
P17.1.23 ①	Ctrl Board OverTemp Fault Bypass Enable				0	1711	See Par ID 2462
P17.1.24 ①	Fieldbus Fault Bypass Enable				0	1713	See Par ID 2462
P17.1.25 ①	Op Cont Interlock Fault Bypass Enable				0	2832	See Par ID 2462

**Table 173. Redundant drive—P17.2.**

Code	Parameter	Min.	Max.	Unit	Default	ID	Note
P17.2.1	Redundant Drive Enable				0	2476	See Par ID 2462
P17.2.2	Drive ID	0	5		0	2278	
P17.2.3	Redundant Run Time Enable				0	2477	See Par ID 2462
P17.2.4	Redundant Run Time Reset					2478	See Par ID 2125
P17.2.5	Redundant RunTime Limit	0.00	300000.00	h	0.00	2479	

**Note:** ① Parameter value can only be changed after the drive has stopped.  
 ② Parameter value will be set to be default when changing macros.  
 ③ Input function is level sensed.  
 ④ Input function is edge sensed.  
 ⑤ Input function is edge sensed when using StartP/StopP start logic.

## Pump parameters

**Table 174. Basic setting—P18.1.**

Code	Parameter	Min.	Max.	Unit	Default	ID	Note
P18.1.1 ①	Multi-pump Mode				0	2279	0 = Disabled 1 = Single Drive Control 2 = Multi Drive Network
P18.1.2 ①	Drive ID	0	5		0	2278	
P18.1.3	PID Bandwidth	0.00	6000.00	Varies	10.00	2458	
P18.1.4 ①	Staging Frequency	See Par ID 101	400.00		50.00	2315	
P18.1.5 ①	De-Staging Frequency	0.00	See Par ID 102		0.00	2316	
P18.1.6	Add/Remove Delay	0	3600	s	10	344	
P18.1.7	Interlock Enable				0	350	See Par ID 2462
P18.1.8 ①	Damper Start				0	483	0 = Normal 1 = Interlock Start 2 = Interlock Tout 3 = Interlock Delay
P18.1.9 ①	Damper Time Out	1	32500	s	5	484	
P18.1.10 ①	Damper Delay	1	32500	s	5	485	
P18.1.11	Derag Cycles	0	10		3	2468	
P18.1.12	Derag at Start/Stop				0	2469	0 = Off 1 = Start 2 = Stop 3 = Start and Stop 4 = Digital Input
P18.1.13	Deragging Run Time	0	3600	s	0	2470	
P18.1.14	Derag Speed	See Par ID 101	See Par ID 102	Hz	5.00	2471	
P18.1.15	Derag Off Delay	1	600	s	10	2472	
P18.1.16 ①	Multi-pump Mode 2				0	2659	See Par ID 2279

## Multi-pump status

**Table 175. Operation mode—P18.2.1.**

Code	Parameter	Min.	Max.	Unit	Default	ID	Note
P18.2.1.1	MPC Drive1 Operate Mode					2218	0 = Offline 1 = Slave Drive 2 = Master Drive 3 = Redundant Drive
P18.2.1.2	MPC Drive2 Operate Mode					2230	See Par ID 2218
P18.2.1.3	MPC Drive3 Operate Mode					2242	See Par ID 2218
P18.2.1.4	MPC Drive4 Operate Mode					2254	See Par ID 2218
P18.2.1.5	MPC Drive5 Operate Mode					2266	See Par ID 2218

**Table 176. Multi-pump status—P18.2.2.**

Code	Parameter	Min.	Max.	Unit	Default	ID	Note
P18.2.2.1	MPC Drive1 Status				5	2219	0 = Stopped 1 = Sleep 2 = Regulating 3 = Wait for CMD 4 = Following 5 = Unknown 6 = Master Local Control 7 = Slave Local Control
P18.2.2.2	MPC Drive2 Status				5	2231	See Par ID 2219
P18.2.2.3	MPC Drive3 Status				5	2243	See Par ID 2219
P18.2.2.4	MPC Drive4 Status				5	2255	See Par ID 2219

**Note:** ① Parameter value can only be changed after the drive has stopped.  
 ② Parameter value will be set to be default when changing macros.  
 ③ Input function is level sensed.  
 ④ Input function is edge sensed.  
 ⑤ Input function is edge sensed when using StartP/StopP start logic.

**Table 176. Multi-pump status—P18.2.2, continued.**

Code	Parameter	Min.	Max.	Unit	Default	ID	Note
P18.2.2.5	MPC Drive5 Status				5	2267	See Par ID 2219

**Table 177. Network status—P18.2.3.**

Code	Parameter	Min.	Max.	Unit	Default	ID	Note
P18.2.3.1	MPC Drive1 NetworkStatus					2220	0 = Disconnected 1 = Fault 2 = Local Control 3 = Pump Lost 4 = Need Alternation 5 = No Error
P18.2.3.2	MPC Drive2 NetworkStatus					2232	See Par ID 2220
P18.2.3.3	MPC Drive3 NetworkStatus					2244	See Par ID 2220
P18.2.3.4	MPC Drive4 NetworkStatus					2256	See Par ID 2220
P18.2.3.5	MPC Drive5 NetworkStatus					2268	See Par ID 2220

## Multi-pump measurement

**Table 178. Latest fault code—P18.3.1.**

Code	Parameter	Min.	Max.	Unit	Default	ID	Note
P18.3.1.1	MPC Drive1 Last Fault Code					2221	
P18.3.1.2	MPC Drive2 Last Fault Code					2233	
P18.3.1.3	MPC Drive3 Last Fault Code					2245	
P18.3.1.4	MPC Drive4 Last Fault Code					2257	
P18.3.1.5	MPC Drive5 Last Fault Code					2269	

**Table 179. Output frequency—P18.3.2.**

Code	Parameter	Min.	Max.	Unit	Default	ID	Note
P18.3.2.1	MPC Drive1 f-Out			Hz		2222	
P18.3.2.2	MPC Drive2 f-Out			Hz		2234	
P18.3.2.3	MPC Drive3 f-Out			Hz		2246	
P18.3.2.4	MPC Drive4 f-Out			Hz		2258	
P18.3.2.5	MPC Drive5 f-Out			Hz		2270	

**Table 180. Motor voltage—P18.3.3.**

Code	Parameter	Min.	Max.	Unit	Default	ID	Note
P18.3.3.1	MPC Drive1 V-Out			V		2223	
P18.3.3.2	MPC Drive2 V-Out			V		2235	
P18.3.3.3	MPC Drive3 V-Out			V		2247	
P18.3.3.4	MPC Drive4 V-Out			V		2259	
P18.3.3.5	MPC Drive5 V-Out			V		2271	

**Note:** ① Parameter value can only be changed after the drive has stopped.  
 ② Parameter value will be set to be default when changing macros.  
 ③ Input function is level sensed.  
 ④ Input function is edge sensed.  
 ⑤ Input function is edge sensed when using StartP/StopP start logic.

## Chapter 8—Multi-purpose application

**Table 181. Motor current—P18.3.4.**

Code	Parameter	Min.	Max.	Unit	Default	ID	Note
P18.3.4.1	MPC Drive1 I-Out			A		2224	
P18.3.4.2	MPC Drive2 I-Out			A		2236	
P18.3.4.3	MPC Drive3 I-Out			A		2248	
P18.3.4.4	MPC Drive4 I-Out			A		2260	
P18.3.4.5	MPC Drive5 I-Out			A		2272	

**Table 182. Motor torque—P18.3.5.**

Code	Parameter	Min.	Max.	Unit	Default	ID	Note
P18.3.5.1	MPC Drive1 M-Out			%		2225	
P18.3.5.2	MPC Drive2 M-Out			%		2237	
P18.3.5.3	MPC Drive3 M-Out			%		2249	
P18.3.5.4	MPC Drive4 M-Out			%		2261	
P18.3.5.5	MPC Drive5 M-Out			%		2273	

**Table 183. Motor power—P18.3.6.**

Code	Parameter	Min.	Max.	Unit	Default	ID	Note
P18.3.6.1	MPC Drive1 P-Out			%		2226	
P18.3.6.2	MPC Drive2 P-Out			%		2238	
P18.3.6.3	MPC Drive3 P-Out			%		2250	
P18.3.6.4	MPC Drive4 P-Out			%		2262	
P18.3.6.5	MPC Drive5 P-Out			%		2274	

**Table 184. Motor speed—P18.3.7.**

Code	Parameter	Min.	Max.	Unit	Default	ID	Note
P18.3.7.1	MPC Drive1 n-Out			rpm		2227	
P18.3.7.2	MPC Drive2 n-Out			rpm		2239	
P18.3.7.3	MPC Drive3 n-Out			rpm		2251	
P18.3.7.4	MPC Drive4 n-Out			rpm		2263	
P18.3.7.5	MPC Drive5 n-Out			rpm		2275	

**Table 185. Run time—P18.3.8.**

Code	Parameter	Min.	Max.	Unit	Default	ID	Note
P18.3.8.1	MPC Drive1 t-Run			h		2228	
P18.3.8.2	MPC Drive2 t-Run			h		2240	
P18.3.8.3	MPC Drive3 t-Run			h		2252	
P18.3.8.4	MPC Drive4 t-Run			h		2264	
P18.3.8.5	MPC Drive5 t-Run			h		2276	

**Table 186. Multi-pump single drive—P18.4.**

Code	Parameter	Min.	Max.	Unit	Default	ID	Note
P18.4.1 ①	Number of Pumps	1	5		1	342	
P18.4.2	Include Freq Converter				1	346	See Par ID 2462
P18.4.3	Auto-Change Enable				0	345	See Par ID 2462
P18.4.4	Auto-Change Interval	0.0	3000.0	h	48.0	347	
P18.4.5	Auto-Change Freq Limit	See Par ID 101	See Par ID 102	Hz	25.00	349	
P18.4.6	Auto-Change Pump Limit	0	5		1	348	

- Note:**
- ① Parameter value can only be changed after the drive has stopped.
  - ② Parameter value will be set to be default when changing macros.
  - ③ Input function is level sensed.
  - ④ Input function is edge sensed.
  - ⑤ Input function is edge sensed when using StartP/StopP start logic.

**Table 186. Multi-pump single drive—P18.4, continued.**

Code	Parameter	Min.	Max.	Unit	Default	ID	Note
P18.4.7 ①	Pipe Fill Aux Pump Select				0	2439	0 = Disabled 1 = Aux Motor 1 2 = Aux Motor 2 3 = Aux Motor 3 4 = Aux Motor 4
P18.4.8 ①	Pipe Fill Aux Pump Run Time	0.0	3600.0	min	0.0	2440	
P18.4.9 ①	Pipe Fill Aux Pump Operation				0	2441	0 = Automatic 1 = Stop
P18.4.10 ①	Pipe Fill Aux Pump Delay	0.0	600.0	min	2.0	2442	

**Table 187. Multi-pump multi-drive—P18.5.**

Code	Parameter	Min.	Max.	Unit	Default	ID	Note
P18.5.1 ①	Number of Drives	1	5		1	2449	
P18.5.2 ①	Regulation Source				0	2284	0 = Network Only 1 = PID Controller 1
P18.5.3 ①	Recovery Method				0	2285	See Par ID 2441
P18.5.4 ①	Callback Source				0	2286	0 = No Action 1 = Safety Torque Off
P18.5.5	Add/Remove Drive Selection				0	2311	0 = Drive ID 1 = Run Time
P18.5.6	Run Time Enable				0	2280	See Par ID 2462
P18.5.7	Run Time Limit	0.0	300000.0	h	0.0	2281	
P18.5.8	Run Time Reset					2283	0 = No Action 1 = Reset
P18.5.9	Master Drive Mode				0	2473	0 = Follow PID 1 = Fixed Speed 2 = Turn Off
P18.5.10	Master Fixed Speed	See Par ID 101	See Par ID 102	Hz	50.00	2474	
P18.5.11	Master Fixed Speed Delay	0	1000	s	5	2475	

**Table 188. Protections—P18.6.**

Code	Parameter	Min.	Max.	Unit	Default	ID	Note
P18.6.1 ①	Pipe Fill Loss Detection Method				0	2406	0 = Motor Current 1 = Motor Power 2 = Motor Torque
P18.6.2	Pipe Fill Loss Level	0.0	1000.0	Varies	0.0	2407	
P18.6.3	Pipe Fill Loss Time	0	600	s	0	2408	
P18.6.4 ①	Pipe Fill Loss Frequency	0.00	See Par ID 102	Hz	0.00	2409	
P18.6.5 ①	Pipe Fill Loss Response				0	2410	See Par ID 2427
P18.6.6	Pipe Fill Loss Attempts	0	10		1	2411	
P18.6.7	Prime Pump Enable				0	2428	See Par ID 190
P18.6.8	Prime Pump Level	0.00	6000.00	Varies	0.00	2429	
P18.6.9	Prime Pump Frequency	See Par ID 101	See Par ID 102	Hz	0.00	2431	
P18.6.10	Prime Pump Delay Time	0.0	3600.0	min	0.0	2432	
P18.6.11	Prime Pump Loss of Prime Level	0.0	1000.0	Varies	0.0	2433	
P18.6.12	Prime Pump Level 2	0.00	6000.00	Varies	0.00	2434	
P18.6.13	Prime Pump Frequency 2	See Par ID 101	See Par ID 102	Hz	0.00	2436	
P18.6.14	Prime Pump Delay Time 2	0.0	3600.0	min	0.0	2437	
P18.6.15	Prime Pump Loss of Prime Level 2	0.0	1000.0	Varies	0.0	2438	

**Note:** ① Parameter value can only be changed after the drive has stopped.  
 ② Parameter value will be set to be default when changing macros.  
 ③ Input function is level sensed.  
 ④ Input function is edge sensed.  
 ⑤ Input function is edge sensed when using StartP/StopP start logic.

## Chapter 8—Multi-purpose application

**Table 188. Protections—P18.6, continued.**

Code	Parameter	Min.	Max.	Unit	Default	ID	Note
P18.6.16 ①	Broken Pipe Fault Response				0	1853	See Par ID 307
P18.6.17	Broken Pipe Level	0.0	6000.0	Varies	15.0	1854	
P18.6.18	Broken Pipe Delay	1.0	120.0	s	15.0	1855	
P18.6.19	Broken Pipe Frequency	1.00	See Par ID 102	Hz	25.00	1856	
P18.6.20	Jockey Pump Enable				0	2804	0 = Not Used 1 = PID Sleep 2 = PID Sleep(Level)
P18.6.21	Jockey Start Level	-99999.99	See Par ID 2807	Varies	0.00	2805	
P18.6.22	Jockey Stop Level	See Par ID 2805	99999.99	Varies	0.00	2807	
P18.6.23	Lube Pump Enable				0	2809	See Par ID 2462
P18.6.24	Lube Pump Time	0.0	300.0	s	0.0	2810	

**Table 189. Real time clock—P19.**

Code	Parameter	Min.	Max.	Unit	Default	ID	Note
P19.1	Interval 1 On Time				0,0,0	491	
P19.2	Interval 1 Off Time				0,0,0	493	
P19.3	Interval 1 From Day				0	517	0 = Sunday 1 = Monday 2 = Tuesday 3 = Wednesday 4 = Thursday 5 = Friday 6 = Saturday
P19.4	Interval 1 To Day				0	518	See Par ID 517
P19.5	Interval 1 Channel				0	519	0 = Not Used 1 = Time Channel 1 2 = Time Channel 2 3 = Time Channel 3
P19.6	Interval 2 On Time				0,0,0	495	
P19.7	Interval 2 Off Time				0,0,0	497	
P19.8	Interval 2 From Day				0	520	See Par ID 517
P19.9	Interval 2 To Day				0	521	See Par ID 517
P19.10	Interval 2 Channel				0	522	See Par ID 519
P19.11	Interval 3 On Time				0,0,0	499	
P19.12	Interval 3 Off Time				0,0,0	501	
P19.13	Interval 3 From Day				0	523	See Par ID 517
P19.14	Interval 3 To Day				0	524	See Par ID 517
P19.15	Interval 3 Channel				0	525	See Par ID 519
P19.16	Interval 4 On Time				0,0,0	503	
P19.17	Interval 4 Off Time				0,0,0	505	
P19.18	Interval 4 From Day				0	526	See Par ID 517
P19.19	Interval 4 To Day				0	527	See Par ID 517
P19.20	Interval 4 Channel				0	528	See Par ID 519
P19.21	Interval 5 On Time				0,0,0	507	
P19.22	Interval 5 Off Time				0,0,0	509	
P19.23	Interval 5 From Day				0	529	See Par ID 517
P19.24	Interval 5 To Day				0	530	See Par ID 517
P19.25	Interval 5 Channel				0	531	See Par ID 519
P19.26	Timer 1 Duration	0	72000	s	0	511	
P19.27	Timer 1 Channel				0	532	See Par ID 519
P19.28	Timer 2 Duration	0	72000	s	0	513	

- Note:**
- ① Parameter value can only be changed after the drive has stopped.
  - ② Parameter value will be set to be default when changing macros.
  - ③ Input function is level sensed.
  - ④ Input function is edge sensed.
  - ⑤ Input function is edge sensed when using StartP/StopP start logic.



**Table 189. Real time clock—P19, continued.**

Code	Parameter	Min.	Max.	Unit	Default	ID	Note
P19.29	Timer 2 Channel				0	533	See Par ID 519
P19.30	Timer 3 Duration	0	72000	s	0	515	
P19.31	Timer 3 Channel				0	534	See Par ID 519
P19.32	Interval 1 Setting				0	2487	0 = Weekly 1 = Daily
P19.33	Interval 2 Setting				0	2488	See Par ID 2487
P19.34	Interval 3 Setting				0	2489	See Par ID 2487
P19.35	Interval 4 Setting				0	2490	See Par ID 2487
P19.36	Interval 5 Setting				0	2491	See Par ID 2487

## Communication

**Table 190. FB process data input Sel—P20.1.**

Code	Parameter	Min.	Max.	Unit	Default	ID	Note
P20.1.1	FB Process Data Input 1 Sel	0	3000		2541	2533	
P20.1.2	FB Process Data Input 2 Sel	0	See Par ID 2533		2542	2534	
P20.1.3	FB Process Data Input 3 Sel	0	See Par ID 2533		2550	2535	
P20.1.4	FB Process Data Input 4 Sel	0	See Par ID 2533		0	2536	
P20.1.5	FB Process Data Input 5 Sel	0	See Par ID 2533		0	2537	
P20.1.6	FB Process Data Input 6 Sel	0	See Par ID 2533		0	2538	
P20.1.7	FB Process Data Input 7 Sel	0	See Par ID 2533		0	2539	
P20.1.8	FB Process Data Input 8 Sel	0	See Par ID 2533		0	2540	

**Table 191. FB process data output Sel—P20.2.**

Code	Parameter	Min.	Max.	Unit	Default	ID	Note
P20.2.1	FB Process Data Output 1 Sel				1	1556	
P20.2.2	FB Process Data Output 2 Sel				2	1557	
P20.2.3	FB Process Data Output 3 Sel				3	1558	
P20.2.4	FB Process Data Output 4 Sel				4	1559	
P20.2.5	FB Process Data Output 5 Sel				5	1560	
P20.2.6	FB Process Data Output 6 Sel				6	1561	
P20.2.7	FB Process Data Output 7 Sel				7	1562	
P20.2.8	FB Process Data Output 8 Sel				28	1563	

- Note:**
- ① Parameter value can only be changed after the drive has stopped.
  - ② Parameter value will be set to be default when changing macros.
  - ③ Input function is level sensed.
  - ④ Input function is edge sensed.
  - ⑤ Input function is edge sensed when using StartP/StopP start logic.

**Table 191. FB process data output Sel—P20.2, continued.**

Code	Parameter	Min.	Max.	Unit	Default	ID	Note
P20.2.9 ②	Standard Status Word Bit0 Function Select				1	2415	0 = Not Used 1 = Ready 2 = Run 3 = Fault 4 = Fault Invert 5 = Warning 6 = Reversed 7 = At Speed 8 = Zero Frequency 9 = Freq Limit 1 Superv 10 = Freq Limit 2 Superv 11 = PID1 Superv 12 = PID2 Superv 13 = OverHeat Fault 14 = OverCurrent Regular 15 = OverVoltage Regular 16 = UnderVoltage Regular 17 = 4mA Ref Fault/ Warning 18 = Ext Brake Control 19 = Ext Brake Inverted 20 = Torq Limit Superv 21 = Ref Limit Superv 22 = Control from I/O 23 = Un-Requested Rotation Direction 24 = Thermistor Fault Output 25 = Fire Mode 26 = In Bypass Mode 27 = Ext Fault/Warning 28 = Remote Control 29 = Jog Speed Select 30 = Motor Therm Protection 31 = FB Digital Input 1 32 = FB Digital Input 2 33 = FB Digital Input 3 34 = FB Digital Input 4 35 = Damper Control 36 = TC1 Status 37 = TC2 Status 38 = TC3 Status 39 = In E-Stop 40 = Power Limit Superv 41 = Temp Limit Superv 42 = Analog Input Superv 43 = Motor 1 Control 44 = Motor 2 Control 45 = Motor 3 Control 46 = Motor 4 Control 47 = Motor 5 Control 48 = Logic Fulfilled 49 = PID1 Sleep 50 = PID2 Sleep 51 = Motor Current 1 Supv 52 = Motor Current 2 Supv 53 = Second AI Limit Supv 54 = DC Charge Switch Close 55 = Preheat Active 56 = Cold Weather Active 57 = Prime Pump Active 58 = 2th Stage Ramp Frequency Active 59 = STO Fault Output

- Note:**
- ① Parameter value can only be changed after the drive has stopped.
  - ② Parameter value will be set to be default when changing macros.
  - ③ Input function is level sensed.
  - ④ Input function is edge sensed.
  - ⑤ Input function is edge sensed when using StartP/StopP start logic.

**Table 191. FB process data output Sel—P20.2, continued.**

Code	Parameter	Min.	Max.	Unit	Default	ID	Note
P20.2.9 ②, continued	Standard Status Word Bit0 Function Select				1	2415	60 = Run Bypass/Drive 61 = Bypass Overload 62 = Bypass Run 63 = Auto Local On COM Fault 64 = FieldBus RTU Fault 65 = FieldBus TCP Fault 66 = FieldBus MSTP Fault 67 = FieldBus EIP Fault 68 = FieldBus SlotA Fault 69 = FieldBus SlotB Fault 70 = FieldBus SWD Fault 71 = Jockey Pump Active 72 = Lube Pump Active 73 = PID1 Low Feedback 74 = PID1 High Feedback 75 = PID2 Low Feedback 76 = PID2 High Feedback 77 = Master in MPFC 78 = CP Interlock Fault
P20.2.10 ②	Standard Status Word Bit1 Function Select				2	2416	See Par ID 2415
P20.2.11 ②	Standard Status Word Bit2 Function Select				3	2417	See Par ID 2415
P20.2.12 ②	Standard Status Word Bit3 Function Select				4	2418	See Par ID 2415
P20.2.13 ②	Standard Status Word Bit4 Function Select				5	2419	See Par ID 2415
P20.2.14 ②	Standard Status Word Bit5 Function Select				6	2420	See Par ID 2415
P20.2.15 ②	Standard Status Word Bit6 Function Select				7	2421	See Par ID 2415
P20.2.16 ②	Standard Status Word Bit7 Function Select				8	2422	See Par ID 2415

## RS-485 bus

**Table 192. Basic setting—P20.3.1.**

Code	Parameter	Min.	Max.	Unit	Default	ID	Note
P20.3.1.1 ①	RS485 Comm Set				0	586	0 = Modbus RTU 1 = BACnet MS/TP 2 = SWD

**Table 193. Modbus RTU—P20.3.2.**

Code	Parameter	Min.	Max.	Unit	Default	ID	Note
P20.3.2.1 ①	Slave Address	1	247		1	587	
P20.3.2.2 ①	Baud Rate				1	584	0 = 9600 1 = 19200 2 = 38400 3 = 57600 4 = 115200
P20.3.2.3 ①	Parity Type And Stop Bit				2	585	0 = None and 2 stop bits 1 = Odd and 1 stop bit 2 = Even and 1 stop bit 3 = None and 1 stop bit

**Note:** ① Parameter value can only be changed after the drive has stopped.  
 ② Parameter value will be set to be default when changing macros.  
 ③ Input function is level sensed.  
 ④ Input function is edge sensed.  
 ⑤ Input function is edge sensed when using StartP/StopP start logic.

## Chapter 8—Multi-purpose application

**Table 193. Modbus RTU—P20.3.2, continued.**

Code	Parameter	Min.	Max.	Unit	Default	ID	Note
P20.3.2.4	Modbus RTU Protocol Status					588	0 = Initial 1 = Stopped 2 = Operational 3 = Faulted
P20.3.2.5	Comm Timeout Modbus RTU	0	60000	ms	10000	593	
P20.3.2.6	Modbus RTU Fault Response				0	2516	0 = in Fieldbus Control 1 = in all Control

**Table 194. BACnet MS/TP—P20.3.3.**

Code	Parameter	Min.	Max.	Unit	Default	ID	Note
P20.3.3.1	MSTP Baud Rate				2	594	0 = 9600 1 = 19200 2 = 38400 3 = 76800 4 = 115200
P20.3.3.2	MSTP Device Address	0	127		1	595	
P20.3.3.3	MSTP Instance Number	0	4194302		0	596	
P20.3.3.4	MSTP Comm Timeout	0	60000	ms	10000	598	
P20.3.3.5	MSTP Protocol Status				0	599	0 = Stopped 1 = Operational 2 = Faulted
P20.3.3.6	MSTP Fault Code				0	600	0 = None 1 = Sole Master 2 = Duplicate MAC ID 3 = Baud rate fault
P20.3.3.7	MSTP Fault Response				0	2526	See Par ID 2516
P20.3.3.8 ①	MSTP Max Master	1	127		127	1537	

**Table 195. Terminal: SWD—P20.3.4.**

Code	Parameter	Min.	Max.	Unit	Default	ID	Note
P20.3.4.1	Parameter Access				1	2630	0 = Local Control 1 = Fieldbus
P20.3.4.2 ①	Process Data Access				4	2631	0 = Local Control 1 = Fieldbus 2 = Mixed Interface 4 = NET, Local on Fault 5 = Dual Mode
P20.3.4.3	Fault Situation Counter					2632	
P20.3.4.4	Board Status					2609	
P20.3.4.5	Firmware Version					2610	
P20.3.4.6	Protocol Status					2612	
P20.3.4.7	Operation Mode					2613	
P20.3.4.8	PDP-Telegram Selection				1	2614	
P20.3.4.9	Fault Counter PDP				0	2615	
P20.3.4.10	Fault Situations Max				8,8	2616	
P20.3.4.11	PDP-Profil Number				809	2618	
P20.3.4.12	PDP-Control Word					2619	
P20.3.4.13	PDP-Status Word				64	2620	
P20.3.4.14	PDP-MaxBlockLength				30	2621	
P20.3.4.15	PDP-NoOfMultiparameter				1	2622	

**Note:** ① Parameter value can only be changed after the drive has stopped.  
 ② Parameter value will be set to be default when changing macros.  
 ③ Input function is level sensed.  
 ④ Input function is edge sensed.  
 ⑤ Input function is edge sensed when using StartP/StopP start logic.

**Table 195. Terminal: SWD—P20.3.4, continued.**

Code	Parameter	Min.	Max.	Unit	Default	ID	Note
P20.3.4.16	PDP-MaxLatency				2	2623	
P20.3.4.17	PDP-DO Manufacturer					2624	
P20.3.4.18	PDP-DO Device Type					1451	
P20.3.4.19	PDP-DO FW-Interface					2625	
P20.3.4.20	PDP-DO FW-Year					2626	
P20.3.4.21	PDP-DO FW-DayMonth					2627	
P20.3.4.22	PDP-DO NoOfDOs				1	2628	
P20.3.4.23	PDP-DO Subclass				1	2629	

**Table 196. EtherNet/IP—P20.4.**

Code	Parameter	Min.	Max.	Unit	Default	ID	Note
P20.4.1 ①	IP Address Mode				0	1500	
P20.4.2	Active IP Address					1507	
P20.4.3	Active Subnet Mask					1509	
P20.4.4	Active Default Gateway					1511	
P20.4.5	MAC Address					1513	
P20.4.6 ①	Static IP Address				192.168.1.254	1501	
P20.4.7 ①	Static Subnet Mask				255.255.255.0	1503	
P20.4.8 ①	Static Default Gateway				192.168.1.1	1505	
P20.4.9	Ethernet IP Protocol Status					608	
P20.4.10	EIP Fault Response				0	2518	See Par ID 2156

**Table 197. Modbus TCP—P20.5.**

Code	Parameter	Min.	Max.	Unit	Default	ID	Note
P20.5.1	Connection Limit				5	609	
P20.5.2	Modbus TCP Unit ID				1	610	
P20.5.3	Comm Timeout Modbus TCP	0	60000	ms	10000	611	
P20.5.4	Modbus TCP Protocol Status					612	See Par ID 599
P20.5.5	Modbus TCP Fault Response				0	2517	See Par ID 2156
P20.5.6	Modbus TCP Trusted IP Enable				0	74	See Par ID 2462
P20.5.7	Trusted IP White List				0xC0.0xA8.0x01.0xFF. 0x00.0x00.0x00.0x00. 0x00.0x00.0x00.0x00	68	

**Table 198. WebUI—P20.6.**

Code	Parameter	Min.	Max.	Unit	Default	ID	Note
P20.6.1	WebUI Protocol Status					2915	
P20.6.2	WebUI Fault Response				0	2916	
P20.6.3	WebUI Communication Timeout	30000	60000	ms	60000	2919	
P20.6.4 ①	WebUI Enable				1	2921	See Par ID 2462

**Note:** ① Parameter value can only be changed after the drive has stopped.  
 ② Parameter value will be set to be default when changing macros.  
 ③ Input function is level sensed.  
 ④ Input function is edge sensed.  
 ⑤ Input function is edge sensed when using StartP/StopP start logic.

## System

**Table 199. Basic setting—P21.1.**

Code	Parameter	Min.	Max.	Unit	Default	ID	Note
P21.1.1	Language				0	340	
P21.1.2 ①	Application					142	
P21.1.3 ①	Parameter Sets					619	
P21.1.4	Up To Keypad					620	See Par ID 2118
P21.1.5 ①	Down From Keypad					621	
P21.1.6	Parameter Comparison					623	
P21.1.7	Password	0	9999		0	624	
P21.1.8	Parameter Lock				0	625	
P21.1.9	Multimonitor Set				0	627	See Par ID 2462
P21.1.10	Default Page				2	628	
P21.1.11	Timeout Time	0	65535	s	30	629	
P21.1.12	Contrast Adjust	5	18		12	630	
P21.1.13	Backlight Time	1	65535	min	10	631	
P21.1.14	Fan Control				1	632	
P21.1.15	Keypad ACK Timeout	200	5000	ms	200	633	
P21.1.16	Keypad Retry Number	1	10		5	634	
P21.1.17	Startup Wizard				0	626	
P21.1.18	Jog Softkey Hidden				0	2412	See Par ID 2462
P21.1.19	Reverse Softkey Hidden				0	2413	See Par ID 2462
P21.1.20	Output Display Unit				45	2424	
P21.1.21	Output Display Unit Min	-60000.00	See Par ID 2425	Varies	0.00	2460	
P21.1.22	Output Display Unit Max	See Par ID 2460	60000.00	Varies	MotorNomFreqMFG	2425	
P21.1.23	Keypad Lock Password	0	9999		0	75	

**Table 200. Version info.—P21.2.**

Code	Parameter	Min.	Max.	Unit	Default	ID	Note
P21.2.1	Keypad Software Version					640	
P21.2.2	Motor Control Software Version					642	
P21.2.3	Application Software Version					644	
P21.2.4	Software Bundle Version					1714	

**Table 201. Application info.—P21.3.**

Code	Parameter	Min.	Max.	Unit	Default	ID	Note
P21.3.1	Brake Chopper Status					646	See Par ID 2118
P21.3.2	Brake Resistor Status					647	See Par ID 2118
P21.3.3	Serial Number					648	
P21.3.4	Power Unit Serial Number					1270	
P21.3.5	Control Unit Serial Number					1276	

**Note:** ① Parameter value can only be changed after the drive has stopped.  
 ② Parameter value will be set to be default when changing macros.  
 ③ Input function is level sensed.  
 ④ Input function is edge sensed.  
 ⑤ Input function is edge sensed when using StartP/StopP start logic.

**Table 202. User info.—P21.4.**

Code	Parameter	Min.	Max.	Unit	Default	ID	Note
P21.4.1	Real Time Clock				0.0.0.1:1:13	566	
P21.4.2	Daylight Saving				0	582	
P21.4.3	Total MWh Count			Mwh		601	
P21.4.4	Total Power Day Count					603	
P21.4.5	Total Power Hr Count					606	
P21.4.6	Trip MWh Count			Mwh		604	
P21.4.7	Clear Trip MWh Count					635	See Par ID 2125
P21.4.8	Trip Power Day Count					636	
P21.4.9	Trip Power Hr Count					637	
P21.4.10	Clear Trip Power Count					639	See Par ID 2125

**Table 203. Operate mode—O.**

Code	Parameter	Min.	Max.	Unit	Default	ID	Note
O1	Output Frequency			Hz		1	
O2	Freq Reference			Hz		24	
O3	Motor Speed			rpm		2	
O4	Motor Current			A		3	
O5	Motor Torque			%		4	
O6	Motor Power			%		5	
O7	Motor Voltage			V		6	
O8	DC-link Voltage			V		7	
O9	Unit Temperature			Deg. C		8	
O10	Motor Temperature			%		9	
R11	Keypad Torque Ref	-300.0	300.0	%	0.0	782	
R12	Keypad Reference	See Par ID 101	See Par ID 102	Hz	0.00	141	
R13	PID1 Keypad Set Point 1	See Par ID 1298	See Par ID 1300	Varies	0.00	1307	
R14	PID1 Keypad Set Point 2	See Par ID 1298	See Par ID 1300	Varies	0.00	1309	

**Note:** ① Parameter value can only be changed after the drive has stopped.  
 ② Parameter value will be set to be default when changing macros.  
 ③ Input function is level sensed.  
 ④ Input function is edge sensed.  
 ⑤ Input function is edge sensed when using StartP/StopP start logic.

## Appendix A—Description of parameters

On the following pages you will find the parameter descriptions arranged according to the parameter number.

Some parameter names are followed by a number code indicating the applications in which the parameter is included. See the list of applications below. The parameter numbers under which the parameter appears in different applications are also given.

### Application level

- 1 Standard application
- 2 Multi-pump and fan application
- 3 Multi-PID application
- 4 Multi-purpose application

Modbus ID	Code	Parameters	Application	RO/RW
1	M1	<b>Output Frequency</b> Output frequency (Hz).	1, 2, 3, 4	RO
24	M2	<b>Freq Reference</b> Reference frequency (Hz).	1, 2, 3, 4	RO
2	M3	<b>Motor Speed</b> Motor output speed (RPM).	1, 2, 3, 4	RO
3	M4	<b>Motor Current</b> Motor output current RMS (Amps).	1, 2, 3, 4	RO
4	M5	<b>Motor Torque</b> Percent motor torque calculated from nameplate values and measured motor current (%).	1, 2, 3, 4	RO
5	M6	<b>Motor Power</b> Percent motor power calculated from nameplate values and measured motor current (%).	1, 2, 3, 4	RO
6	M7	<b>Motor Voltage</b> Output ac motor voltage (Vac).	1, 2, 3, 4	RO
7	M8	<b>DC-link Voltage</b> DC bus voltage (Vdc).	1, 2, 3, 4	RO
8	M9	<b>Unit Temperature</b> Heat sink temperature (deg. C).	1, 2, 3, 4	RO
9	M10	<b>Motor Temperature</b> Motor temperature value calculated from nameplate values and measured motor current (%).	1, 2, 3, 4	RO
15	M11	<b>Torque Reference</b> Torque reference percentage used when in torque control mode.	4	RO
10	M12	<b>Analog Input 1</b> Analog input 1 measured value (Vdc or Amps) selectable with dipswitch.	1, 2, 3, 4	RO
11	M13	<b>Analog Input 2</b> Analog input 2 measured value (Vdc or Amps) selectable with dipswitch.	1, 2, 3, 4	RO
25	M14	<b>Analog Output 1</b> Analog output 1 measured value (Vdc or Amps) selectable with parameter.	1, 2, 3, 4	RO
575	M15	<b>Analog Output 2</b> Analog output 2 measured value (Vdc or Amps) selectable with parameter.	1, 2, 3, 4	RO
12	M16	<b>DI1, DI2, DI3</b> Digital input 1/2/3 status.	1, 2, 3, 4	RO
13	M17	<b>DI4, DI5, DI6</b> Digital input 4/5/6 status.	1, 2, 3, 4	RO
576	M18	<b>DI7, DI8</b> Digital input 7/8 status.	1, 2, 3, 4	RO
14	M19	<b>DO1, Virtual RO1, Virtual RO2</b> Digital output status. The Virtual RO1 and Virtual RO2 status are of internal relays in the control board not for external use.	1, 2, 3, 4	RO
557	M20	<b>RO1, RO2, RO3</b> Relay output 1/2/3 status.	1, 2, 3, 4	RO



Modbus ID	Code	Parameters	Application	RO/RW
558	M21	<b>TC1, TC2, TC3</b> Timer channel status.	2, 3, 4	RO
559	M22	<b>Interval 1</b> Time interval 1 status.	2, 3, 4	RO
560	M23	<b>Interval 2</b> Time interval 2 status.	2, 3, 4	RO
561	M24	<b>Interval 3</b> Time interval 3 status.	2, 3, 4	RO
562	M25	<b>Interval 4</b> Time interval 4 status.	2, 3, 4	RO
563	M26	<b>Interval 5</b> Time interval 5 status.	2, 3, 4	RO
569	M27	<b>Timer 1</b> Timer 1 value in seconds.	2, 3, 4	RO
571	M28	<b>Timer 2</b> Timer 2 value in seconds.	2, 3, 4	RO
573	M29	<b>Timer 3</b> Timer 3 value in seconds.	2, 3, 4	RO
16	M30	<b>PID1 Set Point</b> PID setpoint in process units.	2, 3, 4	RO
18	M31	<b>PID1 Feedback</b> PID feedback level in process units.	2, 3, 4	RO
20	M32	<b>PID1 Error Value</b> PID error in process units.	2, 3, 4	RO
22	M33	<b>PID1 Output</b> PID output (%).	2, 3, 4	RO
23	M34	<b>PID1 Status</b> PID status indication, indicates if drive is stopped, running in PID mode, or in PID sleep mode.	2, 3, 4	RO
32	M35	<b>PID2 Set Point</b> PID setpoint in process units.	3, 4	RO
34	M36	<b>PID2 Feedback</b> PID feedback level in process units.	3, 4	RO
36	M37	<b>PID2 Error Value</b> PID error in process units.	3, 4	RO
38	M38	<b>PID2 Output</b> PID output (%).	3, 4	RO
39	M39	<b>PID2 Status</b> PID status indication, indicates if drive is stopped, running in PID mode, or in PID sleep mode.	3, 4	RO
26	M40	<b>Running Motors</b> Number of auxiliary motors currently running.	2, 3, 4	RO
27	M41	<b>PT100 Temperature</b> PT100 thermistor temperature value in deg. C.	1, 2, 3, 4	RO
28	M42	<b>Latest Fault Code</b> Last active fault code value. See fault codes for the value shown here.	1, 2, 3, 4	RO
583	M43	<b>RTC Battery Status</b> Real time clock battery status.	1, 2, 3, 4	RO
1686	M44	<b>Instant Motor Power</b> Instantaneous motor power (kW).	1, 2, 3, 4	RO
2120	M45	<b>Energy Savings</b> Displays the energy savings of the drive compared to linear V/f curve.	1, 2, 3, 4	RO

## Appendix A—Description of parameters

Modbus ID	Code	Parameters	Application	RO/RW
2209	M46	<p><b>Control Board DIDO Status</b></p> <p>Control board digital input and relay output status provides the status of inputs and outputs on the control board.</p> <p>It is looking at DIN1 - Terminal 20, DIN2 - Terminal 21, DIN3 - Terminal 22, DIN4 - Terminal 23, DIN5 - Terminal 7, DIN6 - Terminal 8, DIN7 - Terminal 9, DIN8 - Terminal 10, DO1 - Terminal 14, RO1 - Terminal 28-29, RO2 - Terminal 32-34, RO3 - Terminal 27 and 31. Along with the onboard I/O being monitored, it also provides status info. on if there are boards in the A or B expander board slots.</p> <p>Bit 0 = DIN1 status            Bit 1 = DIN2 status            Bit 2 = DIN3 status            Bit 3 = DIN4 status            Bit 4 = DIN5 status            Bit 5 = DIN6 status            Bit 6 = DIN7 status            Bit 7 = DIN8 status            Bit 8 = DO1 status            Bit 9 = RO1 status            Bit 10 = RO2 status            Bit 11 = RO3 status            Bit 12 = Slot A with board            Bit 13 = Slot B with board            Bit 14-15 = Not used</p>	1, 2, 3, 4	RO
2210	M47	<p><b>SlotA DIDO Status</b></p> <p>SlotA DIDO status will give the input and output status of a board inserted in the A expander board slot. Depending on the board inserted, different bits will become active if the I/O is enabled.</p> <p>Bit 0 = IO1_DIN1 status            Bit 1 = IO1_DIN2 status            Bit 2 = IO1_DIN3 status            Bit 3 = IO1_DO1 status            Bit 4 = IO1_DO2 status            Bit 5 = IO1_DO3 status            Bit 6 = IO3_RO1 status            Bit 7 = IO3_RO2 status            Bit 8 = IO3_RO3 status            Bit 9 = IO5_AC1 status            Bit 10 = IO5_AC2 status            Bit 11 = IO5_AC3 status            Bit 12 = IO5_AC4 status            Bit 13 = IO5_AC5 status            Bit 14 = IO5_AC6 status            Bit 15 = Not used</p>	1, 2, 3, 4	RO

Modbus ID	Code	Parameters	Application	RO/RW
2211	M48	<p><b>SlotB DIDO Status</b></p> <p>SlotB DIDO Status will give the input and output status of a board inserted in the B expander board slot. Depending on the board inserted different bits will become active if the I/O is enabled.</p> <p>Bit 0 = IO1_DIN1 Status            Bit 1 = IO1_DIN2 Status            Bit 2 = IO1_DIN3 Status            Bit 3 = IO1_DO1 Status            Bit 4 = IO1_DO2 Status            Bit 5 = IO1_DO3 Status            Bit 6 = IO3_RO1 Status            Bit 7 = IO3_RO2 Status            Bit 8 = IO3_RO3 Status            Bit 9 = IO5_AC1 Status            Bit 10 = IO5_AC2 Status            Bit 11 = IO5_AC3 Status            Bit 12 = IO5_AC4 Status            Bit 13 = IO5_AC5 Status            Bit 14 = IO5_AC6 Status            Bit 15 = Not Used</p>	1, 2, 3, 4	RO
29	M49	<p><b>Application Status Word</b></p> <p>Application status word will provide additional status indication of the health of the drive.</p> <p>Bit 0 = MC ready            Bit 1 = MC_run            Bit 2 = MC_fault            Bit 3 = FB_Ref_active            Bit 4 = MC_stopping            Bit 5 = MC_reverse            Bit 6 = MC_Warning/AR-fault            Bit 7 = MC_zerospeed            Bit 8 = I/O control indicate            Bit 9 = Panel control indicator            Bit 10 = Panel Fieldbus indicator            Bit 11 = MC_DC_brake            Bit 12 = RunEnable            Bit 13 = Motor regulator status not zero            Bit 14 = Ext brake control            Bit 15 = Bypass mode</p>	1, 2, 3, 4	RO
2414	M50	<p><b>Standard Status Word</b></p> <p>Standard Status Word is defined based of the parameter setting in the Fieldbus process data output (P20.1) group, P20.1.9 through P20.1.16 define the first 8 bits of this status word. The options for these bits are based off the standard relay functions.</p> <p>Bit 0 = P20.1.9 (default = Ready)            Bit 1 = P20.1.10 (default = Run)            Bit 2 = P20.1.11 (default = Fault)            Bit 3 = P20.1.12 (default = Fault invert)            Bit 4 = P20.1.13 (default = Warning)            Bit 5 = P20.1.14 (default = Reversed)            Bit 6 = P20.1.15 (default = At speed)            Bit 7 = P20.1.16 (default = Zero frequency)            Bit 8 - 15 = Not used</p>	1, 2, 3, 4	RO

## Appendix A—Description of parameters

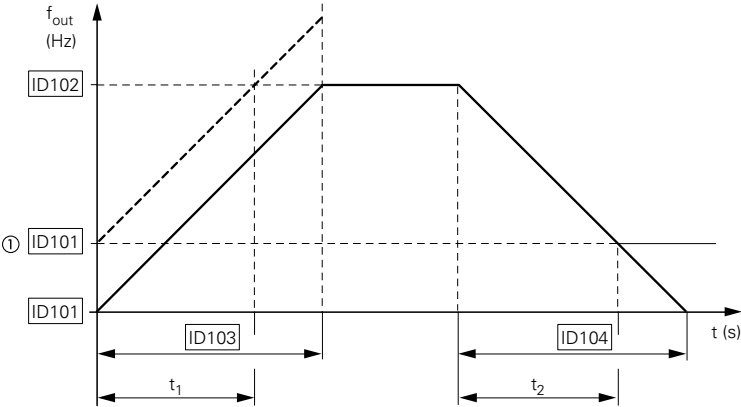
Modbus ID	Code	Parameters	Application	RO/RW
2445	M51	<b>Output</b> User defined output value that can be configured with the users desired unit and scale. This value will be displayed in the format selected by P21.1.20 with a scale value from P21.1.22.	1, 2, 3, 4	RO
2447	M52	<b>Reference</b> User defined reference value that can be configured with the users desired unit and scale. This value will be displayed in the format selected by P21.1.20 with a scale value from P21.1.22.	1, 2, 3, 4	RO
601	M53	<b>Total MWh Count</b> Megawatt hours total operation time counter of the drive output active.	1, 2, 3, 4	RO
603	M54	<b>Total Power Day Count</b> Number of days the drive has been supplied with power.	1, 2, 3, 4	RO
606	M55	<b>Total Power Hr Count</b> Number of hours the drive has been supplied with power.	1, 2, 3, 4	RO
604	M56	<b>Trip MWh Count</b> Megawatts hours of the drive output active since last reset.	1, 2, 3, 4	RO
636	M57	<b>Trip Power Day Count</b> Number of days since the last reset.	1, 2, 3, 4	RO
637	M58	<b>Trip Power Hr Count</b> Number of hours the drive has been running a motor since the last reset.	1, 2, 3, 4	RO
2827	M59	<b>Total Run time Count</b> The total time when drive is running.	1, 2, 3, 4	RO
2830	M60	<b>Numbers Of Start</b> The numbers of drives starts.	1, 2, 3, 4	RO
2829	M61	<b>Trip Run Time Count</b> The run time from last start signal.	1, 2, 3, 4	RO
2101	M62	<b>FB Status Word</b> Fieldbus Status Word is drive status mapped to protocols.	1, 2, 3, 4	RO
2001	M63	<b>FB Ctrol Word</b> Fieldbus control word is protocols control word which mapped to drive.	1, 2, 3, 4	RW
2003	M64	<b>FB Speed Reference</b> Fieldbus frequency reference from protocol.	1, 2, 3, 4	RW
1753	M65	<b>Multi-monitoring</b> Displays any 9 monitoring values in a screen. The values are selectable via the keypad menu. By going to the Multi-monitor page and seeing 3 lines of monitoring values. The Up and Down keys can be used to select the row and then hitting the left arrow key will allow for editing the value then by going up and down.	1, 2, 3, 4	RW
101	P1.1	<b>Min Frequency</b> Defines the lowest frequency at which the drive will operate. This setting will limit other frequency parameter settings: 1 = Fire mode frequency 2 = Derag 3 = MPFC staging frequency 4 = MPFC master fixed frequency 5 = Prime pump frequency 6 = Prime pump frequency2	1, 2, 3, 4	RW

Modbus ID	Code	Parameters	Application	RO/RW
102	P1.2	<b>Max Frequency</b> Defines the highest frequency at which the drive will operate. This will limit other frequency parameters: 1 = Keypad reference 3 = Motor potentiome 3 = Jog speed 4 = 2nd stage ramp frequency 5 = Fire mode min. frequency 6 = Derag 7 = MPFC staging frequency 8 = MPFC master fixed frequency 9 = Prime pump frequency 10 = Prime pump frequency2 11 = Preset speed frequency 12 = Frequency limit value 13 = Reference limit value 14 = SpeedControl_fs2 15 = Stall frequency limit 16 = 4mA fault frequency 17 = MPFC de-staging frequency 18 = Pipe fill loss frequency low 19 = Pipe fill loss frequency high 20 = Broken pipe frequency limit)	1, 2, 3, 4	RW

103	P1.3	<b>Accel Time 1</b> Defines the time required for the output frequency to accelerate from zero frequency to maximum frequency (P1.2).	1, 2, 3, 4	RW
-----	------	--	------------	----

104	P1.4	<b>Decel Time 1</b> Defines the time required for the output frequency to decelerate from maximum frequency to zero frequency (P1.2).	1, 2, 3, 4	RW
-----	------	--	------------	----

Figure 38. Acceleration and deceleration time.



The values for the acceleration time  $t_1$  and the deceleration time  $t_2$  are calculated as follows:

$$t_1 = \frac{(ID102 - ID101) \times ID103}{ID102} \qquad t_2 = \frac{(ID102 - ID101) \times ID104}{ID102}$$

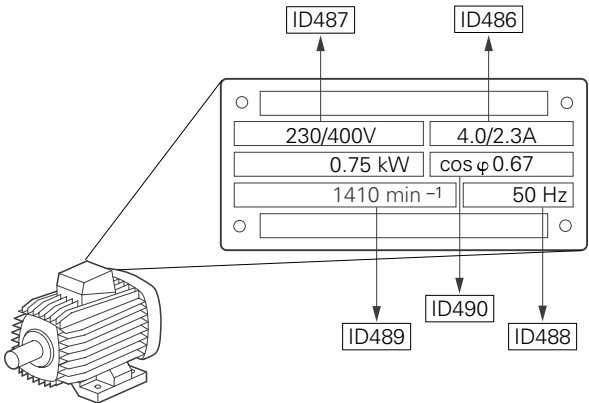
The defined acceleration (ID103) and deceleration times ID104 apply for all changes to the frequency setpoint value.

If the start-release (FWD, REV) is switched off, the output frequency ( $f_{out}$ ) is immediately set to zero. The motor runs down uncontrolled.

If a controlled run-down is requested (with value from ID104), stop mode should be set to ramp.

① When setting a minimum output frequency (ID104 greater than 0 Hz), the acceleration and deceleration time of the drive is reduced to  $t_1$  or  $t_2$ .

## Appendix A—Description of parameters

Modbus ID	Code	Parameters	Application	RO/RW
486	P1.5	<p><b>Motor Nom Current</b></p> <p>Motor nameplate rated full load current. This value is found on the rating plate of the motor.</p> <p><b>Figure 39. Motor parameters from ratings plate.</b></p> 	1, 2, 3, 4	RW
489	P1.6	<p><b>Motor Nom Speed</b></p> <p>Motor nameplate rated speed, This value is found on the rating plate of the motor.</p>	1, 2, 3, 4	RW
490	P1.7	<p><b>Motor PF</b></p> <p>Motor nameplate rated power factor. This value is found on the rating plate of the motor.</p>	1, 2, 3, 4	RW
487	P1.8	<p><b>Motor Nom Voltage</b></p> <p>Motor nameplate rated voltage. This value is found on the rating plate of the motor.</p>	1, 2, 3, 4	RW
488	P1.9	<p><b>Motor Nom Frequency</b></p> <p>Motor nameplate rated frequency, This value is found on the rating plate of the motor.</p>	1, 2, 3, 4	RW
1685	P1.10	<p><b>Power Up Local Remote Select</b></p> <p>Selects what control place the drive will start at after power is applied. The default setting will hold the last state that the drive was in when powered down. Selecting Local or Remote will cause the drive to start in that mode regardless of last state.</p>	1, 2, 3, 4	RW
135	P1.11	<p><b>Remote 1 Control Place</b></p> <p>Defines the signal location for the start command in remote mode. I/O terminals would be from the digital hardwired inputs or keypad for Start/Stop buttons on the drive. Keypad display will indicate what mode is selected.</p>	1, 2, 3, 4	RW
1695	P1.12	<p><b>Local Control Place</b></p> <p>Defines the signal location for the start command in local mode. I/O terminals would be from the digital hardwired inputs or keypad for Start/Stop buttons on the drive. Keypad display will indicate what mode is selected.</p>	1, 2, 3, 4	RW
2462	P1.13	<p><b>Bumpless Enable</b></p> <p>When switching between Local or Remote control places when enabled the output of the drive will not change to the new reference place until that reference value is adjusted when in the new control place.</p>	1, 2, 3, 4	RW
136	P1.14	<p><b>Local Reference</b></p> <p>Defines the signal location for the speed reference in local mode.</p>	1, 2, 3, 4	RW
137	P1.15	<p><b>Remote 1 Reference</b></p> <p>Defines the signal location for the speed reference in remote mode.</p>	1, 2, 3, 4	RW
1679	P1.16	<p><b>Reverse Enable</b></p> <p>Enables or disables the reverse motor direction.</p>	1, 2, 3, 4	RW
2423	P1.17	<p><b>Run Delay Time</b></p> <p>Run Delay time parameter sets the time required for the drive to wait before another run command can be received. During this time the run signal is given it is ignored until the time has expired upon which it will then start, this is true for keypad, I/O, or Fieldbus Control places.</p>	1, 2, 3, 4	RW

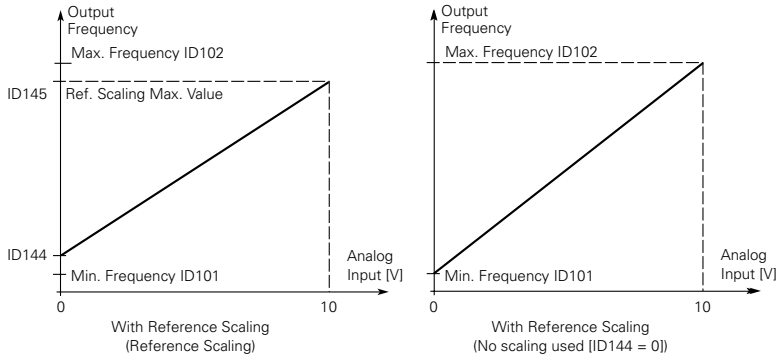
<b>Modbus ID</b>	<b>Code</b>	<b>Parameters</b>	<b>Application</b>	<b>RO/RW</b>
2465	P1.18	<p><b>HOA Source</b></p> <p>Enables the HOA control function. If enabled it selected the desired location for switching between Hand, Off, and Auto control locations.</p> <p>0 = Disabled - Off is disable and the standard Loc/Rem is used.</p> <p>1 = HOA Source: I/O Terminal - Drive is looking for control source selection via I/O terminals. Have to use the HOA On/Off digital input along with Force Hand or Remote to function.</p> <p>2 = HOA Source: Keypad - Keypad Loc/Rem button will function as the switch between Hand/Off/Auto.</p>	1, 2, 3, 4	RW
1813	P1.19	<p><b>Minimum Run Time</b></p> <p>Drive minimum run time.</p>	1, 2, 3, 4	RW
2840	P1.20	<p><b>Frequency Reference Upper Limit</b></p> <p>The max. value of frequency reference. It is used to limit the value of frequency reference.</p>	1, 2, 3, 4	RW
2841	P1.21	<p><b>Frequency Reference Upper Limit Source</b></p> <p>Frequency reference upper limit source select:</p> <p>0 = Not used.</p> <p>1 = Freq Ref upper.</p> <p>2 = AI1.</p> <p>3 = AI2.</p>	1, 2, 3, 4	RW
1820	P1.22	<p><b>Motor Type Selection</b></p> <p>Defines the type of motor connected to the drive, Standard Induction motor, internally mounted permanent magnet, or surface mount permanent magnet.</p>	4	RW
144	P2.1.1	<p><b>AI Ref Scale Min Value</b></p> <p>Defines the minimum frequency associated with 0% input from the analog input. Setting AI ref scale min. value and AI ref scale max. value both to zero will cause the analog input to scale to the minimum and maximum frequencies.</p>	1, 2, 3, 4	RW

# Appendix A—Description of parameters

Modbus ID	Code	Parameters	Application	RO/RW
145	P2.1.2	<b>AI Ref Scale Max Value</b>	1, 2, 3, 4	RW

Defines the maximum frequency associated with 100% input from the analog input. Setting AI ref scale min. value and AI ref scale max. value both to zero will cause the analog input to scale to the minimum and maximum frequencies.

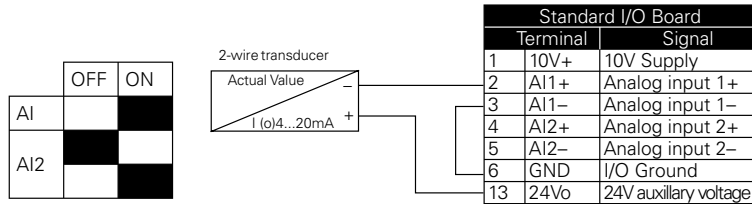
**Figure 40. With and without reference scaling.**



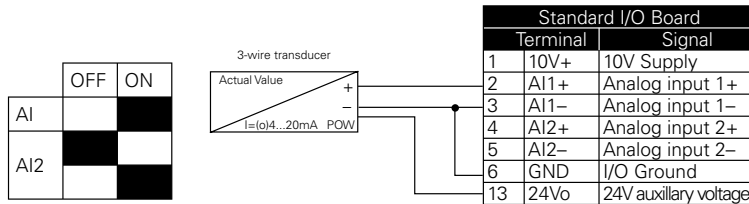
222	P2.2.1	<b>AI1 Mode</b>	1, 2, 3, 4	RW
-----	--------	-----------------	------------	----

Selects the analog input mode for AI1 terminals 2 and 3 for current or voltage. Also need to set DIP switches on control board, left of the keypad. If using the 10 V supply on terminal 1 of the drive, it will require a ground jumper from terminal 6 to the AI1- input terminal 3 to complete the loop. When doing a current loop with an external supply, the ground jumper is not required.

**Figure 41. AI1 2 wire-current.**



**Figure 42. AI1 3 wire-current**

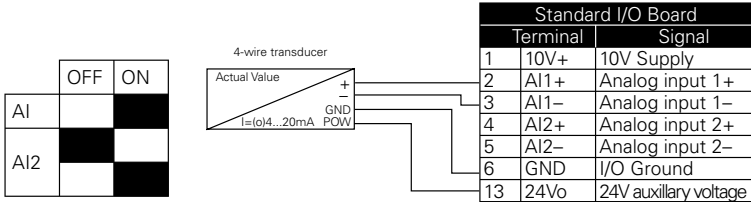




Modbus ID	Code	Parameters	Application	RO/RW
222	P2.2.1	<b>AI1 Mode, continued</b>	1, 2, 3, 4	RW

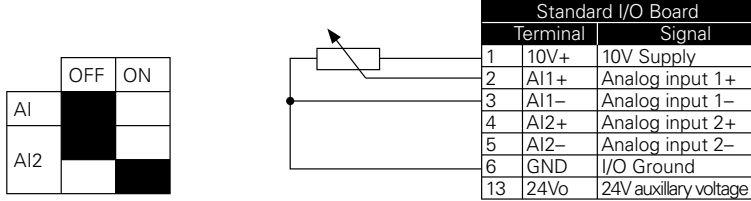
Selects the analog input mode for AI1 terminals 2 and 3 for current or voltage. Also need to set DIP switches on control board, left of the keypad. If using the 10 V supply on terminal 1 of the drive, it will require a ground jumper from terminal 6 to the AI- input terminal 3 to complete the loop. When doing a current loop with an external supply, the ground jumper is not required.

Figure 43. AI1 4 wire-current.



1 = 0-10V - If using the 10V supply on Terminal 1 of the drive, it will require a ground jumper from Terminal 6 to the AI1- input terminal 3 as in Figure 45.

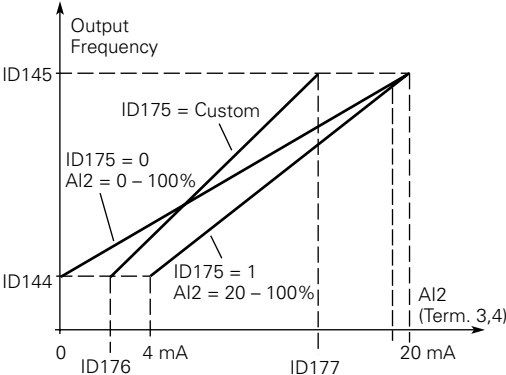
Figure 44. AI1 reference potentiometer 10 V.



175	P2.2.2	<b>AI1 Signal Range</b>	1, 2, 3, 4	RW
-----	--------	-------------------------	------------	----

With this parameter, you can select the analog input 1 signal range.  
 0-100% is equal to 0 to 10 V/ 0-20 mA  
 20-100% is equal to 2 to 10 V, 4-20 mA.  
 For selection "Customized," see "AI1 Custom Min" and " AI1 Custom Max". This enables a customized signal range.

Figure 45. Analog input AI scaling.



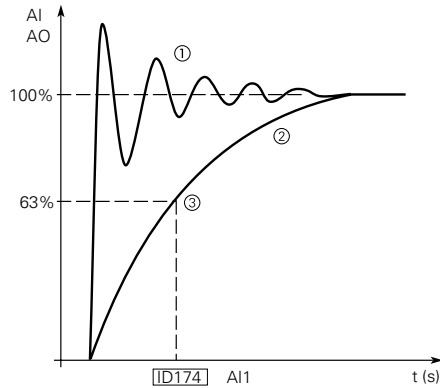
176	P2.2.3	<b>AI1 Custom Min</b>	1, 2, 3, 4	RW
Defines the minimum percentage for the input range to be associated with AI Ref Min. scale.				
177	P2.2.4	<b>AI1 Custom Max</b>	1, 2, 3, 4	RW
Defines the maximum percentage for the input range to be associated with AI Ref Max. scale.				

## Appendix A—Description of parameters

Modbus ID	Code	Parameters	Application	RO/RW
174	P2.2.5	<b>AI1 Filter Time</b>	1, 2, 3, 4	RW

Defines the filter time applied to the analog input signal. Zero equals no filtering.

**Figure 46. AI1 signal filtering.**



- Notes:**
- ① Unfiltered analog signal.
  - ② Filtered analog signal.
  - ③ Filter time constant at 63% of the set value.

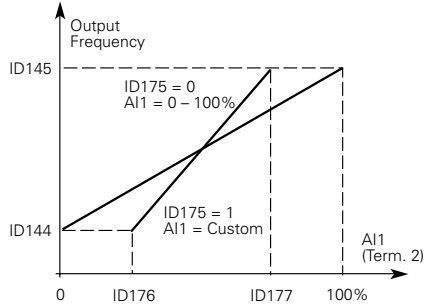
181	P2.2.6	<b>AI1 Signal Invert</b>	1, 2, 3, 4	RW
-----	--------	--------------------------	------------	----

Inverts the reference signal. Maximum reference becomes minimum frequency and minimum reference becomes maximum frequency.

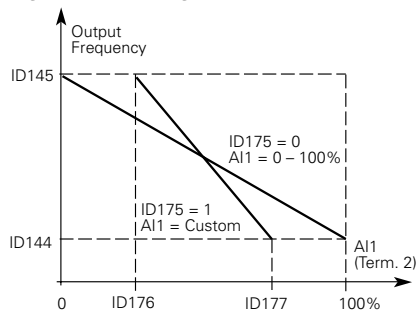
0 = No inversion of analog Vin signal takes place.

1 = Inversion of analog signal takes place.

**Figure 47. AI1 - No signal inversion.**



**Figure 48. AI1 Signal Inversion**



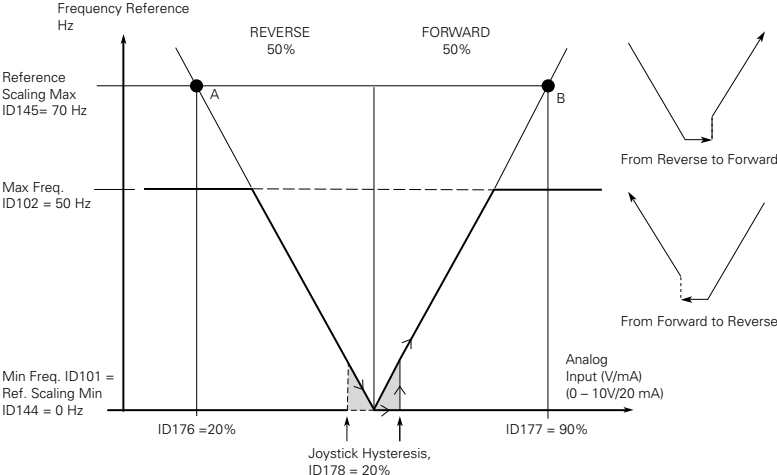
Maximum AI1 signal = minimum set speed.

Minimum AI1 signal = maximum set speed.

Modbus ID	Code	Parameters	Application	RO/RW
178	P2.2.7	<b>A11 Joystick Hyst</b>	1, 2, 3, 4	RW

Defines the joystick hysteresis between 0 and 20%, when the analog input is within this range the drive will interpret this as a zero speed reference.

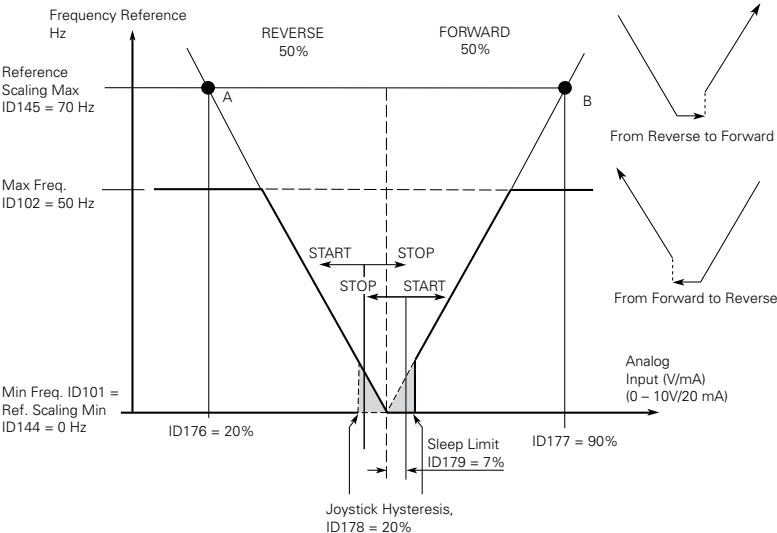
Figure 49. Example of joystick hysteresis.



179	P2.2.8	<b>A11 Sleep Limit</b>	1, 2, 3, 4	RW
-----	--------	------------------------	------------	----

Defines the sleep level of the analog input. If the analog input signal is below this level for a time greater than the Analog Sleep Delay, the drive will transition to a sleep state and restart when the analog input increases above this level.

Figure 50. Example of sleep limit function.



180	P2.2.9	<b>A11 Sleep Delay</b>	1, 2, 3, 4	RW
-----	--------	------------------------	------------	----

Defines the delay for the analog input sleep level.

133	P2.2.10	<b>A11 Joystick Offset</b>	1, 2, 3, 4	RW
-----	---------	----------------------------	------------	----

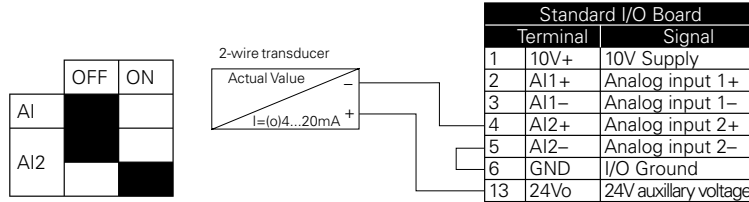
Joysticks zero point by default is the middle of AI range. Joystick offset defines how much the zero point is moved in the forward or reverse from this analog input centerpoint.

# Appendix A—Description of parameters

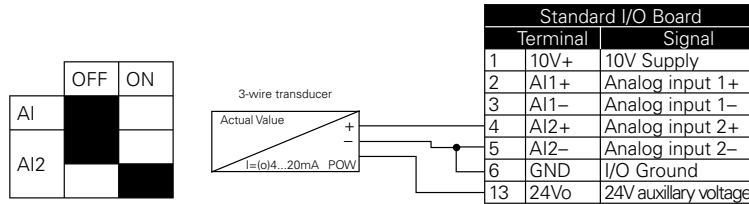
Modbus ID	Code	Parameters	Application	RO/RW
223	P2.3.1	<b>AI2 Mode</b>	1, 2, 3, 4	RW

Selects the analog input mode for AI2 terminal 4 and 5. For current or voltage, also need to set DIP switches on control board. If using the 10 V supply on terminal 1 of the drive, it will require a ground jumper from terminal 6 to the AI2- input terminal 5 to complete the loop. When doing a current loop with an external supply the ground jumper is not required.

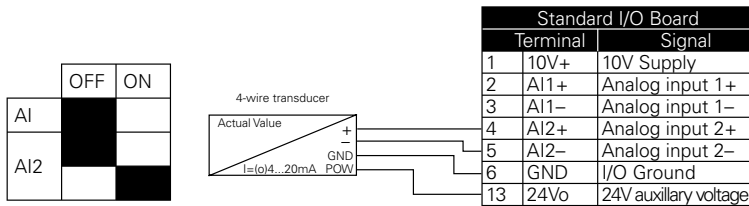
**Figure 51. AI2 2 wire-current.**



**Figure 52. AI2 3 wire-current.**

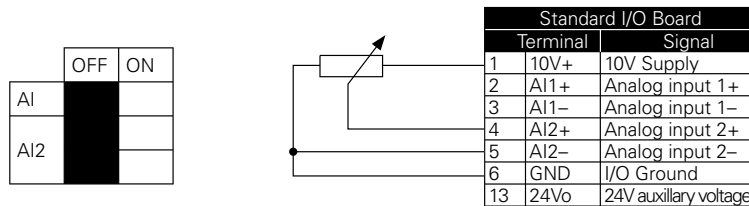


**Figure 53. AI2 4 wire-current.**



1 = 0-10 V - If using the 10 V supply on terminal 1 of the drive, it will require a ground jumper from terminal 6 to the AI2- input terminal 5 as in Figure 55.

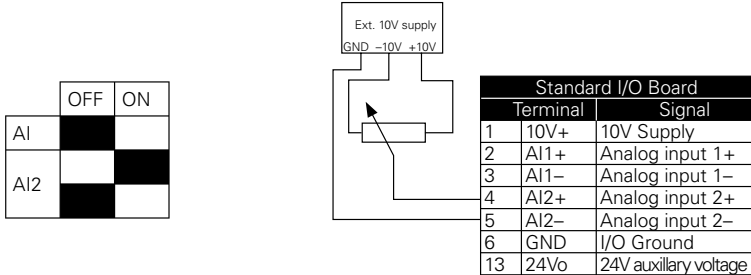
**Figure 54. AI2 pot ref.**



Modbus ID	Code	Parameters	Application	RO/RW
223	P2.3.1	<b>AI2 Mode, continued</b>	1, 2, 3, 4	RW

2 = -10 V to +10 Vdc - Voltage loop with a +10 and a -10 volt differential supply as in Figure 56.

Figure 55. AI2 differential voltage.



183	P2.3.2	<b>AI2 Signal Range</b>	1, 2, 3, 4	RW
-----	--------	-------------------------	------------	----

With this parameter you can select the analog input 2 signal range. 0-100% is equal to 0 to 10 V, 0-20 mA, or -10 V to 10 V depending on the selection of AI2 Mode 20-100% is equal to 2 to 10 V, 4-20 mA.

For selection "Customized", see "AI2 Custom Min" (P2.3.3) and "AI2 Custom Max" (P2.3.4). This enables a customized signal range.

184	P2.3.3	<b>AI2 Custom Min</b>	1, 2, 3, 4	RW
-----	--------	-----------------------	------------	----

Defines the minimum percentage for the input range to be associated with AI Ref Min. scale.

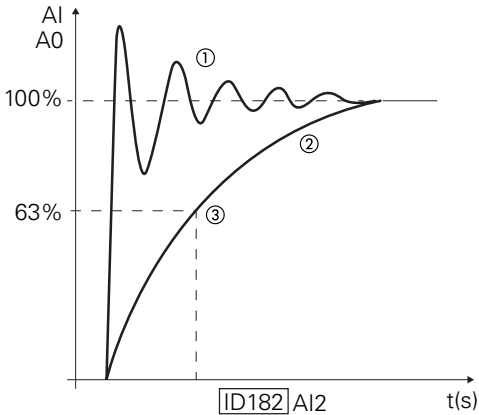
185	P2.3.4	<b>AI2 Custom Max</b>	1, 2, 3, 4	RW
-----	--------	-----------------------	------------	----

Defines the maximum percentage for the input range to be associated with AI Ref Max. scale.

182	P2.3.5	<b>AI2 Filter Time</b>	1, 2, 3, 4	RW
-----	--------	------------------------	------------	----

Defines the filter time applied to the analog input signal, zero equals no filtering.

Figure 56. AI2 filter time.

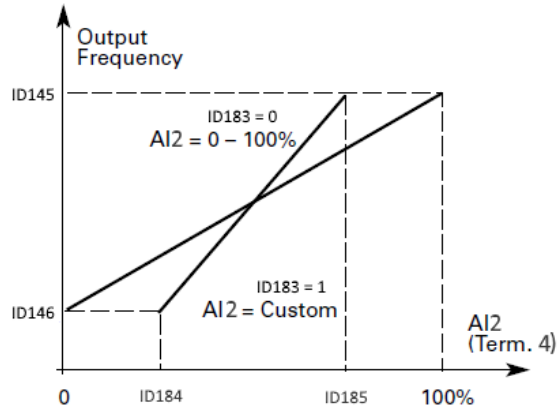


- Notes:**
- ① Unfiltered analog signal.
  - ② Filtered analog signal.
  - ③ Filter time constant at 63% of the set value.

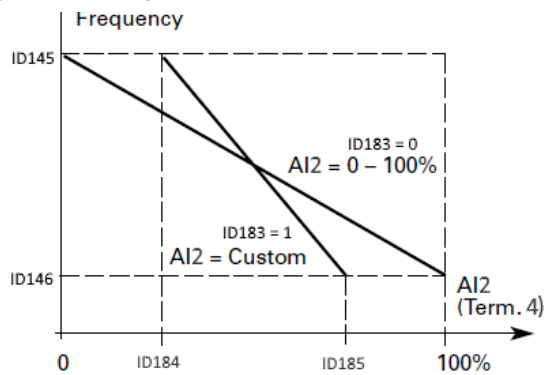
## Appendix A—Description of parameters

Modbus ID	Code	Parameters	Application	RO/RW
189	P2.3.6	<b>AI2 Signal Invert</b> Inverts the reference signal. Maximum reference becomes minimum frequency and minimum reference becomes maximum frequency. 0 = No inversion of analog Vin signal takes place. 1 = Inversion of analog signal takes place.	1, 2, 3, 4	RW

**Figure 57. AI2 - No signal inversion.**



**Figure 58. AI2 signal inversion.**

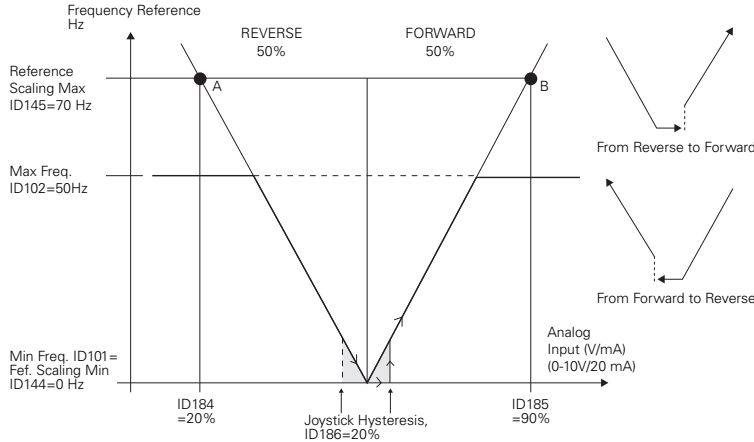


Maximum AI2 signal = minimum set speed.  
 Minimum AI2 signal = maximum set speed.

Modbus ID	Code	Parameters	Application	RO/RW
186	P2.3.7	<b>A12 Joystick Hyst</b>	1, 2, 3, 4	RW

Defines the joystick hysteresis. When the analog input is within this range the drive will interpret this as a zero speed reference.

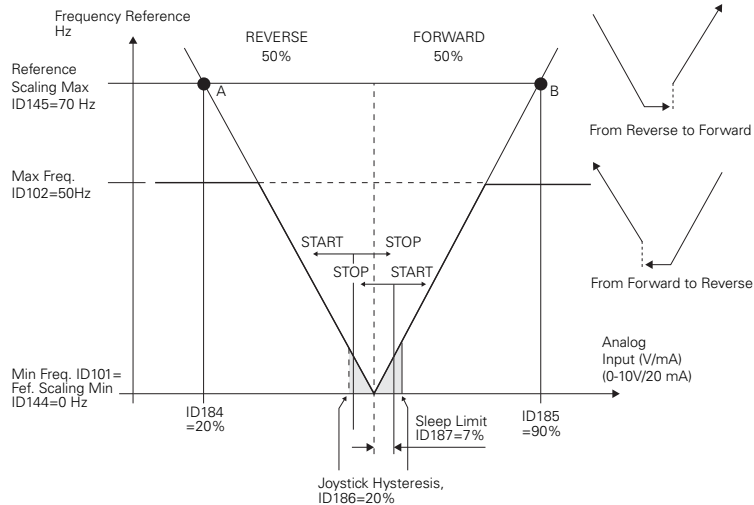
Figure 59. Example of joystick hysteresis.



187	P2.3.8	<b>A12 Sleep Limit</b>	1, 2, 3, 4	RW
-----	--------	------------------------	------------	----

Defines the sleep level of the analog input, if the analog input signal is below this level for a time greater than the Analog Sleep Delay the drive will transition to a sleep state and restart when the analog input increases above this level.

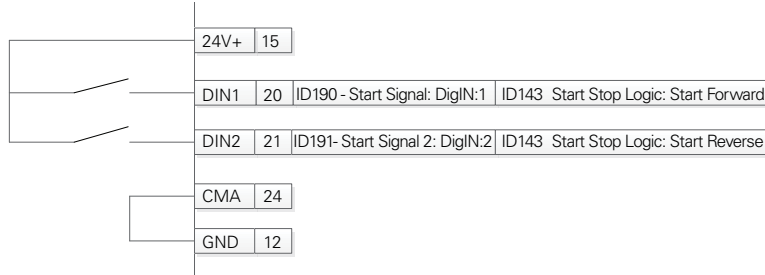
Figure 60. Example of sleep limit function.



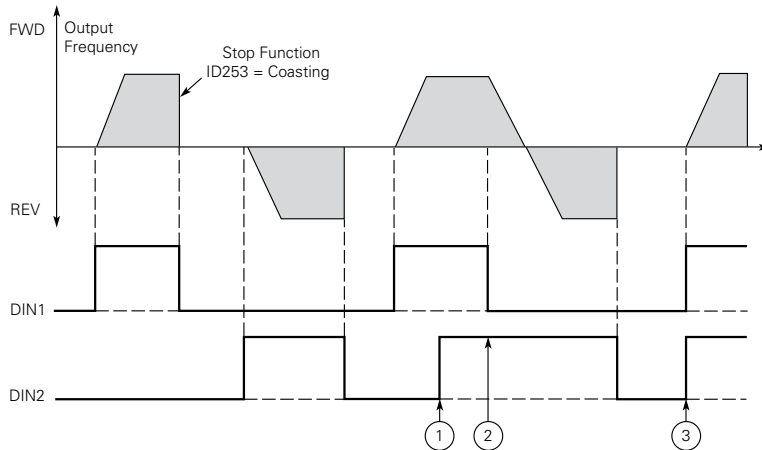
188	P2.3.9	<b>A12 Sleep Delay</b>	1, 2, 3, 4	RW
Defines the delay for the analog input sleep level.				
134	P2.3.10	<b>A12 Joystick Offset</b>	1, 2, 3, 4	RW
Joysticks zero point by default is the middle of AI range. Joystick offset defines how much the zero point is moved in the forward or reverse from this analog input centerpoint.				
2484	P2.4.1	<b>Fine Tuning Input</b>	1, 2, 3, 4	RW
Selects the Analog input used for Fine adjustment tuning of a reference signal.				
0 = Not Used				
1 = Analog Input 1				
2 = Analog Input 2				

## Appendix A—Description of parameters

Modbus ID	Code	Parameters	Application	RO/RW
2485	P2.4.2	<b>Fine Tuning Min</b> Percentage that is subtracted from the main reference when adjust input is at minimum.	1, 2, 3, 4	RW
2486	P2.4.3	<b>Fine Tuning Max</b> Percentage that is added from the main reference when adjust input is at maximum.	1, 2, 3, 4	RW
143	P3.1	<b>I0 Terminal 1 Start Stop Logic</b> For the DI function, we use terminal programming method to function (TTF). You have a fixed input or output for which you define a certain function. 0 = P3.2 DI closed contact = start forward: P3.3 DI closed contact = start reverse. This would be considered 2 wire control with either a contact used on the Start FWD or Start REV commands - contacts open and the motor stops.	1, 2, 3, 4	RW



**Figure 61. Start forward/start reverse.**

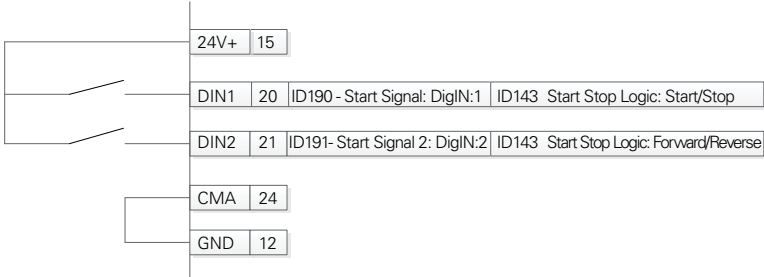


- Notes:**
- ① The first selected direction has the highest priority.
  - ② When the DIN1 contact opens the direction of rotation starts to change.
  - ③ If Start forward (DIN1) and Start reverse (DIN2) signals are active simultaneously the Start forward signal (DIN1) has priority.

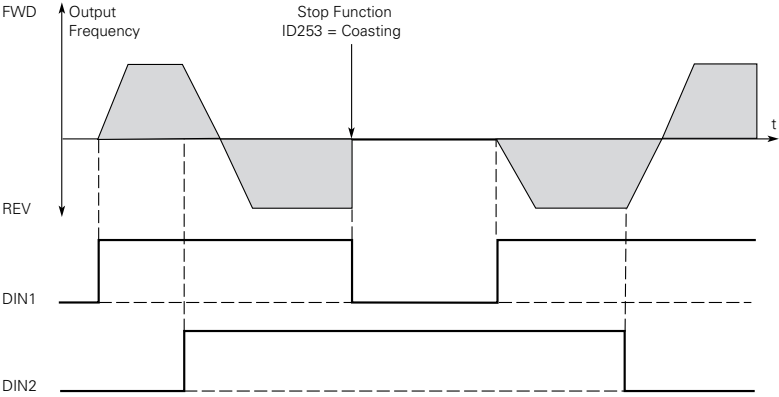


Modbus ID	Code	Parameters	Application	RO/RW
143	P3.1	<b>IO Terminal 1 Start Stop Logic, continued</b>	1, 2, 3, 4	RW

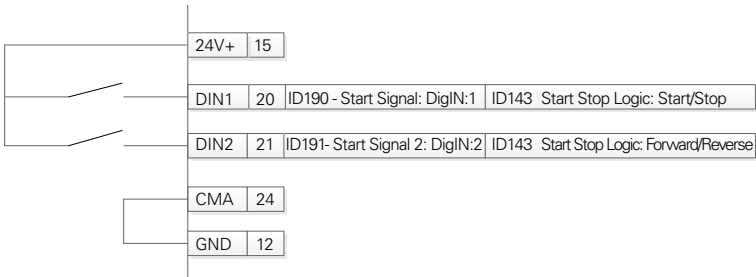
1 = P3.2 DI closed contact = start / open contact = stop: P3.3 DI closed contact = reverse / open contact = forward. This would be considered 2 wire control with a contact on start/stop - contact opens it stops and direction on 2nd start signal.



**Figure 62. Start, stop, and reverse.**



2 = P3.2 DI closed contact = start / open contact = stop: P3.3 DI closed contact = start enabled / open contact = start disabled and drive stopped if running motor direction keeps forward. This would be considered 3 wire control with Start signal 2 required to be closed to enable stStart on Start signal 1.



## Appendix A—Description of parameters

Modbus ID	Code	Parameters	Application	RO/RW
143	P3.1	<p><b>IO Terminal 1 Start Stop Logic, continued</b></p> <p>3 = Three-wire connection (pulse control): P3.2 DI changes from open to closed = start pulse: P3.2 DI changes from closed to open = stop pulse: P3.5 DI closed contact = reverse/ open contact = forward. This would be considered 3 wire control with Start signal 1 being the Start pulse and Start signal 2 being the NC Stop.</p>	1, 2, 3, 4	RW
<p><b>Figure 63. Start pulse/stop pulse.</b></p>				
190	P3.2	<p><b>IO Terminal 1 Start Signal 1</b></p> <p>Signal selection 1 for the start/stop logic listed in P3.1. This parameter would correspond to the function listed for DIN1. When the parameter is set to DigiN: 1, it references DIN1 on the control board. Selecting different DIGIN values will assign it to a different input on the control board or option card. When set to Normally Open, this function would be always tied low or 0 when using I/O terminal 1 as the control place. When value is set to Normally Closed, this will cause the function to be always on and activate the output if I/O Terminal 1 is the current control place. Can be set to DigiIN:X indicates on board terminal inputs, DigiIN:A:IOX:X indicates optional board inputs in A slot, DigiIN:B:IOX:X indicates optional board inputs in B slot, or Timer Channel X).</p>	1, 2, 3, 4	RW
191	P3.3	<p><b>IO Terminal 1 Start Signal 2</b></p> <p>Signal selection 2 for the start/stop logic listed listed in P3.1. This parameter would correspond to the function listed for DIN2. When the parameter is set to DigiN: 2, it references DIN2 on the control board. Selecting different DIGIN values will assign it to a different input on the control board or option card. When set to Normally Open, this function would be always tied low or 0 when using I/O terminal 1 as the control place. When value is set to Normally Closed, this will cause the function to be always on and activate the output if I/O Terminal 1 is the current control place. Can be set to DigiIN:X indicates on board terminal inputs, DigiIN:A:IOX:X indicates optional board inputs in A slot, DigiIN:B:IOX:X indicates optional board inputs in B slot, or Timer Channel X).</p>	1, 2, 3, 4	RW
881	P3.4	<p><b>Thermistor Input Select</b></p> <p>This parameter defines DIN7, and DIN8 is digital input or thermistor input. When this parameter is enabled it switches DIN7 and DIN8 to a thermistor input that triggers at 4.7k ohm.</p>	1, 2, 3, 4	RW

Modbus ID	Code	Parameters	Application	RO/RW
198	P3.5	<p><b>Reverse</b></p> <p>Allows for switching the direction of the motor when using 3 wire start/stop logic. Can be set to DigilN:X indicates on board terminal inputs, DigilN:A:IOX:X indicates optional board inputs in A slot, DigilN:B:IOX:X indicates optional board inputs in B slot, or Timer Channel X</p> <p>Contact Open = Forward direction. Contact Close = Reverse direction.</p>	1, 2, 3, 4	RW
192	P3.6	<p><b>Ext. Fault 1 NO</b></p> <p>Allows for external input causing drive to fault. This function is defined as NO so the function activates on a closed contact. If this function is assigned to Normally Open, the function is always off so the drive will not fault. When set to Normally Closed, the function will be active and fault all the time. The additional settings allow assigning them to an input to control the function. Different Settings DigilN:X indicates on board terminal inputs, DigilN:A:IOX:X indicates optional board inputs in A slot, DigilN:B:IOX:X indicates optional board inputs in B slot, or Timer Channel X. The description on the fault can be changed in P3.52. RO X Function allows for having an input turn on without having to hard wire it to the physical relay output.</p> <p>Closed contact = external fault. Open contact = no external fault.</p>	1, 2, 3, 4	RW
193	P3.7	<p><b>Ext. Fault 1 NC</b></p> <p>Allows for external input causing drive to fault. This function is defined as NC so the function activates on a open contact. If this function is assigned to Normally Closed, the function is always on so the drive will not fault. When set to Normally Open, the function will be active and fault all the time. The additional settings allow assigning them to an input to control the function. Different Settings DigilN:X indicates on board terminal inputs, DigilN:A:IOX:X indicates optional board inputs in A slot, DigilN:B:IOX:X indicates optional board inputs in B slot, or Timer Channel X. The description on the fault can be changed in P3.52. RO X Function allows for having an input turn on without having to hard wire it to the physical relay output.</p> <p>Closed contact = no external fault. Open contact = external fault.</p>	1, 2, 3, 4	RW
200	P3.8	<p><b>Fault Reset</b></p> <p>Allows for external fault reset input. This function is looking for a rising edge to reset a fault. If this function is set for Normally Open, the drive will not do a reset via the control terminals. When set for Normally Closed, the fault condition will always be trying to reset on the rising edge. When it is tied to an input on the control board or option card the function would be set to DIGIN: and the input desired. Can be set to DigilN:X indicates on board terminal inputs, DigilN:A:IOX:X indicates optional board inputs in A slot, DigilN:B:IOX:X indicates optional board inputs in B slot, or Timer Channel X. RO X Function allows for having an input turn on without having to hard wire it to the physical relay output.</p> <p>DI change from open contact to closed contact: reset fault.</p>	1, 2, 3, 4	RW

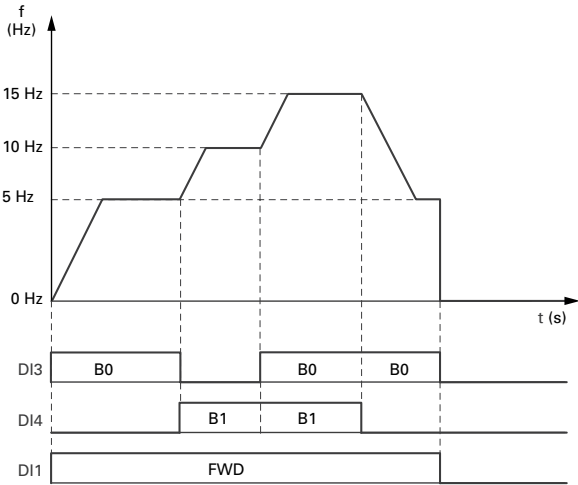
## Appendix A—Description of parameters

Modbus ID	Code	Parameters	Application	RO/RW
194	P3.9	<p><b>Run Enable</b></p> <p>Allows for safety start input that is required along with start command for frequency converter to turn on output. When using this command if the function is set for Normally Open, the drive will see this as a open input and not allow the drive to run due to no Ready. The default state being Normally Closed indicates that the drive is in a Ready condition and will accept the start command. When assigned to one of the DIGIN or Time channels it requires the input to be high to activate output. Can be set to DigiIN:X indicates on board terminal inputs, DigiIN:A:IOX:X indicates optional board inputs in A slot, DigiIN:B:IOX:X indicates optional board inputs in B slot, or Timer Channel X. RO X Function allows for having an input turn on without having to hard wire it to the physical relay output.</p> <p>Closed contact = Start of motor enabled Open contact = Start of motor disabled</p>	1, 2, 3, 4	RW
205	P3.10	<p><b>Preset Speed B0</b></p> <p>Preset bit select inputs to select preset speed reference values. Validating 3 digital inputs will allow for 7 preset speeds to be obtained. When switching between inputs it will follow the acceleration and deceleration time. When all the inputs are set to Normally Open none of the preset speeds will be enabled and the output will follow the control place reference command. If the function is set for Normally Closed the drive will follow the preset speed assigned to the inputs enabled. When assigned to one of the DIGIN on the control board or an installed option card it is looking for a high input to enable that preset. Can be set to DigiIN:X indicates on board terminal inputs, DigiIN:A:IOX:X indicates optional board inputs in A slot, DigiIN:B:IOX:X indicates optional board inputs in B slot, or Timer Channel X. RO X Function allows for having an input turn on without having to hard wire it to the physical relay output.</p>	1, 2, 3, 4	RW
206	P3.11	<p><b>Preset Speed B1</b></p> <p>Preset bit select inputs to select preset speed reference values. Validating 3 digital inputs will allow for 7 preset speeds to be obtained. When switching between inputs it will follow the acceleration and deceleration time. When all the inputs are set to Normally Open none of the preset speeds will be enabled and the output will follow the control place reference command. If the function is set for Normally Closed the drive will follow the preset speed assigned to the inputs enabled. When assigned to one of the DIGIN on the control board or an installed option card it is looking for a high input to enable that preset. Can be set to DigiIN:X indicates on board terminal inputs, DigiIN:A:IOX:X indicates optional board inputs in A slot, DigiIN:B:IOX:X indicates optional board inputs in B slot, or Timer Channel X. RO X Function allows for having an input turn on without having to hard wire it to the physical relay output.</p>	1, 2, 3, 4	RW

Modbus ID	Code	Parameters	Application	RO/RW
207	P3.12	<b>Preset Speed B2</b>	1, 2, 3, 4	RW

Preset bit select inputs to select preset speed reference values. Validating 3 digital inputs will allow for 7 preset speeds to be obtained. When switching between inputs it will follow the acceleration and deceleration time. When all the inputs are set to Normally Open none of the preset speeds will be enabled and the output will follow the control place reference command. If the function is set for Normally Closed the drive will follow the preset speed assigned to the inputs enabled. When assigned to one of the DIGIN on the control board or an installed option card it is looking for a high input to enable that preset. Can be set to DigilN:X indicates on board terminal inputs, DigilN:A:IOX:X indicates optional board inputs in A slot, DigilN:B:IOX:X indicates optional board inputs in B slot, or Timer Channel X. RO X Function allows for having an input turn on without having to hard wire it to the physical relay output.

**Figure 64. Activation of fixed frequencies.**



**Fixed frequency**

Input (Binary)			Fixed frequency
B0	B1	B2	(Factory setting)
X	—	—	Preset Speed 1, ID105 = 5 Hz
—	X	—	Preset Speed 2, ID106 = 10 Hz
X	X	—	Preset Speed 3, ID118 = 15 Hz
—	—	X	Preset Speed 4, ID119 = 20 Hz
X	—	X	Preset Speed 5, ID120 = 25 Hz
—	X	X	Preset Speed 6, ID121 = 30 Hz
X	X	X	Preset Speed 7, ID122 = 35 Hz

550	P3.13	<b>PID1 Control Enable</b>	2, 3, 4	RW
-----	-------	----------------------------	---------	----

Allows for activating PID1 control mode when it is set as a reference place in local reference (P1.1.13) or remote reference (P1.1.14). If the input is not enabled when starting the drive with PID1 Controller set as the reference, the drive output will not start. Can be set to DigilN:X indicates on board terminal inputs, DigilN:A:IOX:X indicates optional board inputs in A slot, DigilN:B:IOX:X indicates optional board inputs in B slot, or Timer Channel X. RO X function allows for having an input turn on without having to hard wire it to the physical relay output.  
Contact Close: Enables PID 1 control mode.

553	P3.14	<b>PID2 Control Enable</b>	3, 4	RW
-----	-------	----------------------------	------	----

Allows for activating PID2 control mode when it is set as a reference place in local reference (P1.1.13) or remote reference (P1.1.14). If the input is not enabled when starting the drive with PID2 Controller set as the reference the drive output will not start. Can be set to DigilN:X indicates on board terminal inputs, DigilN:A:IOX:X indicates optional board inputs in A slot, DigilN:B:IOX:X indicates optional board inputs in B slot, or Timer Channel X. RO X Function allows for having an input turn on without having to hard wire it to the physical relay output.  
Contact Close: Enables PID 2 control mode.

## Appendix A—Description of parameters

Modbus ID	Code	Parameters	Application	RO/RW
195	P3.15	<p><b>Accel/Decel Time Set</b></p> <p>Selects between accel/decel time 1 and accel/decel time 2. When this function is set for Normally Open the Accel/Decel time set will follow time 1 always, when set for Normally Closed it will follow the 2nd Accel/Decel time always. Assigning it to an input will allow for the input to control this. Can be set to DigiIN:X indicates on board terminal inputs, DigiIN:A:IOX:X indicates optional board inputs in A slot, DigiIN:B:IOX:X indicates optional board inputs in B slot, or Timer Channel X. RO X Function allows for having an input turn on without having to hard wire it to the physical relay output.</p> <p>Closed contact = 2nd set of acc/dec time applied. Open contact = 1st set of acc/dec time applied.</p>	1, 2, 3, 4	RW
201	P3.16	<p><b>Accel/Decel Prohibit</b></p> <p>Disables the ability to change speed, even if the reference signal changes if this input is enabled the output stays at the value it was at before the input was enabled. When this functions is set for Normally Open the Accel/Decel will be allowed via the desired control source, when is set for Normally Closed the drive will prohibit changing of speed from any control source. Can be set to DigiIN:X indicates on board terminal inputs, DigiIN:A:IOX:X indicates optional board inputs in A slot, DigiIN:B:IOX:X indicates optional board inputs in B slot, or Timer Channel X. RO X Function allows for having an input turn on without having to hard wire it to the physical relay output.</p> <p>Closed contact: drive output frequency cannot rise or fall, it keeps on current output.</p>	1, 2, 3, 4	RW
215	P3.17	<p><b>No Access To Param</b></p> <p>Locks out the ability to change parameters when this input is enabled, this can be used with the password protection. When this function is set for Normally Open it will allow for changing of parameters, if it is set for Normally Closed it prevents any changes to parameters. If a input is desired to control this DIGIN X can be used. Can be set to DigiIN:X indicates on board terminal inputs, DigiIN:A:IOX:X indicates optional board inputs in A slot, DigiIN:B:IOX:X indicates optional board inputs in B slot, or Timer Channel X. RO X Function allows for having an input turn on without having to hard wire it to the physical relay output.</p> <p>Closed contact: all writable parameters cannot be edited.</p>	1, 2, 3, 4	RW
203	P3.18	<p><b>Accel Pot Value</b></p> <p>Motor Potentiometer is set for a reference, when this input is enabled it will increase reference value till contact opens. When this function is set for Normally Open it will not cause the Motor Pot reference to increase, when this is set for Normally Closed it will cause the Motor pot reference to increase till it reaches max frequency. Can be set to DigiIN:X indicates on board terminal inputs, DigiIN:A:IOX:X indicates optional board inputs in A slot, DigiIN:B:IOX:X indicates optional board inputs in B slot, or Timer Channel X. RO X Function allows for having an input turn on without having to hard wire it to the physical relay output.</p> <p>Closed contact: Potentiometer value keeps on rising.</p>	4	RW
204	P3.19	<p><b>Decel Pot Value</b></p> <p>Motor Potentiometer is set for a reference, when this input is enabled it decrease reference value till contact opens. When this function is set for Normally Open it will not cause the Motor Pot reference to decrease, when this is set for Normally Closed it will cause the Motor pot reference to decrease till the min frequency is reached.Can be set to DigiIN:X indicates on board terminal inputs, DigiIN:A:IOX:X indicates optional board inputs in A slot, DigiIN:B:IOX:X indicates optional board inputs in B slot, or Timer Channel X. RO X Function allows for having an input turn on without having to hard wire it to the physical relay output.</p> <p>Closed contact: Potentiometer value keeps on falling.</p>	4	RW
216	P3.20	<p><b>Reset Pot Zero</b></p> <p>Sets Motor Potentiometer reference value to zero when using the Motor Potentiometer as a Reference signal when contact closes. When this is set for Normally Open it will not cause the Motor Pot reference to not reset to 0 speed, when this is set for Normally Closed it will cause the Motor pot reference to reset to 0 speed and stay there till the opens. Can be set to DigiIN:X indicates on board terminal inputs, DigiIN:A:IOX:X indicates optional board inputs in A slot, DigiIN:B:IOX:X indicates optional board inputs in B slot, or Timer Channel X. RO X Function allows for having an input turn on without having to hard wire it to the physical relay output.</p> <p>Closed contact: Potentiometer value reset to zero.</p>	4	RW

Modbus ID	Code	Parameters	Application	RO/RW
196	P3.21	<p><b>Remote Control</b></p> <p>Selection allows for external control panel to control frequency converters control place. When this function is set for Normally Open the drive will not go into the remote control unless the keypad input is pressed. When set for Normally Closed the drive will always be in the remote location no matter the keypad loc/rem is pressed. Can be set to DigiIN:X indicates on board terminal inputs, DigiIN:A:IOX:X indicates optional board inputs in A slot, DigiIN:B:IOX:X indicates optional board inputs in B slot, or Timer Channel X. RO X Function allows for having an input turn on without having to hard wire it to the physical relay output.</p> <p>Closed Contact: force to remote control.</p>	1, 2, 3, 4	RW
197	P3.22	<p><b>Local Control</b></p> <p>Selection allows for external control panel to control frequency converters control place. When this function is set for Normally Open the drive will not go into the local control place unless the keypad Loc/Rem button is used. When it is set for Normally Closed it will always be in the local control location no matter if the keypad loc/rem button is pressed. Can be set to DigiIN:X indicates on board terminal inputs, DigiIN:A:IOX:X indicates optional board inputs in A slot, DigiIN:B:IOX:X indicates optional board inputs in B slot, or Timer Channel X. RO X Function allows for having an input turn on without having to hard wire it to the physical relay output.</p> <p>Closed contact: force to local control.</p>	1, 2, 3, 4	RW
209	P3.23	<p><b>Remote 1/2 Select</b></p> <p>Selection allows for switching between Remote control 1 (P1.11 and P1.14) and control 2 (P7.1 and P7.2). This switches control and reference locations. When this function is set for Normally Open, the drive will not go into the Remote 2 control place and will stay in Remote 1. When it is set for Normally Closed, the drive will always be in the Remote 2 Control Place. When a DIGIN is used, it will allow cycling between the two based off high/low state. Can be set to DigiIN:X indicates on board terminal inputs, DigiIN:A:IOX:X indicates optional board inputs in A slot, DigiIN:B:IOX:X indicates optional board inputs in B slot, or Timer Channel X. RO X Function allows for having an input turn on without having to hard wire it to the physical relay output.</p> <p>Closed contact: Remote 2 is selected as control source.</p> <p>Open contact: Remote 1 is selected as control.</p>	1, 2, 3, 4	RW
217	P3.24	<p><b>Second Motor Para Select</b></p> <p>Selection allows for switching between motor parameter set 1(P1 Group) and set 2 (P16 Group). When this function is set for Normally pen the drive will follow the first set of motor parameters and when the input is set for Normally Closed it will used the Second Motor Parameter set. If an input is used the function will follow the logic of the input being high/low. Can be set to DigiIN:X indicates on board terminal inputs, DigiIN:A:IOX:X indicates optional board inputs in A slot, DigiIN:B:IOX:X indicates optional board inputs in B slot, or Timer Channel X. RO X Function allows for having an input turn on without having to hard wire it to the physical relay output.</p> <p>Closed contact: the 2nd motor parameters is applied.</p>	2, 3, 4	RW
218	P3.25	<p><b>Force Bypass</b></p> <p>Selection allows for switching between bypass and drive modes. When this input is enabled the Bypass output contactor is enabled to bypass the drive, when disabled this relay opens. When the input is enabled on the rising edge the bypass output contactor function is enabled in the output functions on the drive. When this fault is set for Normally Open/Normally Closed the drive will not activate the bypass relay output function due to the drive looking for a rising edge trigger. Can be set to DigiIN:X indicates on board terminal inputs, DigiIN:A:IOX:X indicates optional board inputs in A slot, DigiIN:B:IOX:X indicates optional board inputs in B slot, or Timer Channel X. RO X Function allows for having an input turn on without having to hard wire it to the physical relay output.</p> <p>Closed contact: switch to bypass.</p> <p>Open contact: switch to drive.</p>	2, 3, 4	RW
202	P3.26	<p><b>DC Brake Active</b></p> <p>Selection enables DC brake on a closed contact. When enabled, this will cause the drive to inject DC voltage into the motor to assist in bring it to a stop. When this function is set for Normally Open, the drive will not activate the DC brake function. When Normally Closed is used, the drive will always have the DC brake function activated. Can be set to DigiIN:X indicates on board terminal inputs, DigiIN:A:IOX:X indicates optional board inputs in A slot, DigiIN:B:IOX:X indicates optional board inputs in B slot, or Timer Channel X. RO X Function allows for having an input turn on without having to hard wire it to the physical relay output.</p> <p>Closed contact: DC brake function is enable.</p>	1, 2, 3, 4	RW

## Appendix A—Description of parameters

Modbus ID	Code	Parameters	Application	RO/RW
219	P3.27	<p><b>Smoke Mode</b></p> <p>Selection enables the smoke purge preset speed to be enabled. When this function is set for Normally Open the drive will not activate the Smoke Mode frequency. When Normally Closed is used the drive will always run at the Smoke Purge Frequency. Can be set to DigiIN:X indicates on board terminal inputs, DigiIN:A:IOX:X indicates optional board inputs in A slot, DigiIN:B:IOX:X indicates optional board inputs in B slot, or Timer Channel X. RO X Function allows for having an input turn on without having to hard wire it to the physical relay output.</p> <p>Closed contact: drive is in smoke purge mode.</p>	2, 3, 4	RW
220	P3.28	<p><b>Fire Mode</b></p> <p>Selection enables drive into fire mode where faults will be ignored and preset speeds are given for reference commands to the drive, the reference are selectable in the P15 Group. When this function is set for Normally Open or Normally Closed it will depend on the setting in the Fire Mode parameter group, if the function activates on an open contact and this is set for Normally Open it will always be in the Fire Mode, if Normally Closed is used then the function will always be off. Vice versa will occur if Fire Mode is active on an Closed contact. Can be set to DigiIN:X indicates on board terminal inputs, DigiIN:A:IOX:X indicates optional board inputs in A slot, DigiIN:B:IOX:X indicates optional board inputs in B slot, or Timer Channel X. RO X Function allows for having an input turn on without having to hard wire it to the physical relay output.</p> <p>Closed contact: drive is in fire mode. Ignores all the faults.</p> <p><b>Note:</b> When Fire mode is enabled, this causes the drive to ignore all faults except hardware overcurrent, STO, saturation fault. Warranty will be non valid in the case this is enabled and the drive causes issues to the system.</p>	2, 3, 4	RW
221	P3.29	<p><b>Fire Mode Ref 1/2 Select</b></p> <p>Selection allows for switching between fire mode speed reference 1 (P15.4) and reference 2 (P15.5). When this function is set for Normally Open and the drive is in Fire Mode, it will follow Fire Mode Ref 1. If the function is set for Normally Closed, it will follow Fire Mode Ref 2. Can be set to DigiIN:X indicates on board terminal inputs, DigiIN:A:IOX:X indicates optional board inputs in A slot, DigiIN:B:IOX:X indicates optional board inputs in B slot, or Timer Channel X. RO X Function allows for having an input turn on without having to hard wire it to the physical relay output.</p> <p>Closed contact: drive output reference frequency selection 2.</p>	2, 3, 4	RW
351	P3.30	<p><b>PID1 Set Point Select</b></p> <p>Selection allows for selecting between Setpoint 1 and setpoint 2 when in the PID control mode, depending on the PID Controller you are using this will all for multiple setpoints. When this function is set for Normally Open and the drive is in PID mode, it will use the first PID Set Point Reference. When the function is set for Normally Close the 1st PID Set Point will be active. Can be set to DigiIN:X indicates on board terminal inputs, DigiIN:A:IOX:X indicates optional board inputs in A slot, DigiIN:B:IOX:X indicates optional board inputs in B slot, or Timer Channel X. RO X Function allows for having an input turn on without having to hard wire it to the physical relay output.</p> <p>Closed contact: setpoint2 is selected for pid1.</p> <p>Open contact:setpoint1 is selected for pid1.</p>	2, 3, 4	RW
352	P3.31	<p><b>PID2 Set Point Select</b></p> <p>Selection allows for selecting between Setpoint 1 and setpoint 2 when in the PID control mode, depending on the PID Controller you are using this will all for multiple setpoints. When this function is set for Normally Open and the drive is in PID mode, it will use the first PID Set Point Reference. When the function is set for Normally Close the 2nd PID Set Point will be active. Can be set to DigiIN:X indicates on board terminal inputs, DigiIN:A:IOX:X indicates optional board inputs in A slot, DigiIN:B:IOX:X indicates optional board inputs in B slot, or Timer Channel X. RO X Function allows for having an input turn on without having to hard wire it to the physical relay output.</p> <p>Closed contact: setpoint2 is selected for pid1.</p> <p>Open contact:setpoint1 is selected for pid1.</p>	3, 4	RW
199	P3.32	<p><b>Jog Enable</b></p> <p>Selection enables the jog frequency reference and starts the drive to slowly advance the system. When this function is set for Normally Open the drive will not follow the jog enable speed. If the function is set for Normally Close then the output will be activated and run at the Jog Frequency. Can be set to DigiIN:X indicates on board terminal inputs, DigiIN:A:IOX:X indicates optional board inputs in A slot, DigiIN:B:IOX:X indicates optional board inputs in B slot, or Timer Channel X. RO X Function allows for having an input turn on without having to hard wire it to the physical relay output.</p> <p>Closed contact: drive is under jog mode.</p>	1, 2, 3, 4	RW



Modbus ID	Code	Parameters	Application	RO/RW
224	P3.33	<p><b>Start Timer 1</b></p> <p>Selection enables the timer functions to begin counting. When this function is set for Normally Open the drive will not start the Timer sequence. If the function is set for Normally Close the Timer function will start. When assigned to an input the input active will start the timer. Can be set to DigiIN:X indicates on board terminal inputs, DigiIN:A:IOX:X indicates optional board inputs in A slot, DigiIN:B:IOX:X indicates optional board inputs in B slot, or Timer Channel X. RO X Function allows for having an input turn on without having to hard wire it to the physical relay output.</p> <p>Closed contact: Timer1, Timer2, or Timer3 will be started.</p>	2, 3, 4	RW
225	P3.34	<p><b>Start Timer 2</b></p> <p>Selection enables the timer functions to begin counting. When this function is set for Normally Open the drive will not start the Timer sequence. If the function is set for Normally Close the Timer function will start. When assigned to an input the input active will start the timer. Can be set to DigiIN:X indicates on board terminal inputs, DigiIN:A:IOX:X indicates optional board inputs in A slot, DigiIN:B:IOX:X indicates optional board inputs in B slot, or Timer Channel X. RO X Function allows for having an input turn on without having to hard wire it to the physical relay output.</p> <p>Closed contact: Timer1, Timer2, or Timer3 will be started.</p>	2, 3, 4	RW
226	P3.35	<p><b>Start Timer 3</b></p> <p>Selection enables the timer functions to begin counting. When this function is set for Normally Open the drive will not start the Timer sequence. If the function is set for Normally Close the Timer function will start. When assigned to an input the input active will start the timer. Can be set to DigiIN:X indicates on board terminal inputs, DigiIN:A:IOX:X indicates optional board inputs in A slot, DigiIN:B:IOX:X indicates optional board inputs in B slot, or Timer Channel X. RO X Function allows for having an input turn on without having to hard wire it to the physical relay output.</p> <p>Closed contact: Timer1, Timer2, or Timer3 will be started.</p>	2, 3, 4	RW
208	P3.36	<p><b>AI Ref Source Select</b></p> <p>Selection switches between AI1 and AI2 reference signals that are located on the control board. When this function is set for Normally Open the drive will follow the AI1 input. If the function is set for Normally Close, the AI2 input would then be active. Can be set to DigiIN:X indicates on board terminal inputs, DigiIN:A:IOX:X indicates optional board inputs in A slot, DigiIN:B:IOX:X indicates optional board inputs in B slot, or Timer Channel X. RO X Function allows for having an input turn on without having to hard wire it to the physical relay output.</p> <p>Closed contact: AI2 is selected for reference source.</p> <p>Open contact: AI1 is selected for reference source.</p>	1, 2, 3, 4	RW
210	P3.37	<p><b>Motor Interlock 1</b></p> <p>Selects inputs allowed to verify aux motors are connected to allow them to run, if inputs are disabled drive will see this as a motor not connected and skip over the motor in the booster/auto-change sequence. When this function is set for Normally Open the drive will not see a motor interlock enabled when doing multi-pump and fan. If the function is set for Normally Close the drive will initialize that motors are connected to allow running. These are ideally tied to aux contacts on the output contactor to the motor. Can be set to DigiIN:X indicates on board terminal inputs, DigiIN:A:IOX:X indicates optional board inputs in A slot, DigiIN:B:IOX:X indicates optional board inputs in B slot, or Timer Channel X. RO X Function allows for having an input turn on without having to hard wire it to the physical relay output.</p> <p>Closed contact: motor interlock signal activated.</p> <p>Open contact: motor interlock signal unactivated.</p>	2, 3, 4	RW
211	P3.38	<p><b>Motor Interlock 2</b></p> <p>Selects inputs allowed to verify aux motors are connected to allow them to run, if inputs are disabled drive will see this as a motor not connected and skip over the motor in the booster/auto-change sequence. When this function is set for Normally Open the drive will not see a motor interlock enabled when doing multi-pump and fan. If the function is set for Normally Close the drive will initialize that motors are connected to allow running. These are ideally tied to aux contacts on the output contactor to the motor. Can be set to DigiIN:X indicates on board terminal inputs, DigiIN:A:IOX:X indicates optional board inputs in A slot, DigiIN:B:IOX:X indicates optional board inputs in B slot, or Timer Channel X. RO X Function allows for having an input turn on without having to hard wire it to the physical relay output.</p> <p>Closed contact: motor interlock signal activated.</p> <p>Open contact: motor interlock signal unactivated.</p>	2, 3, 4	RW

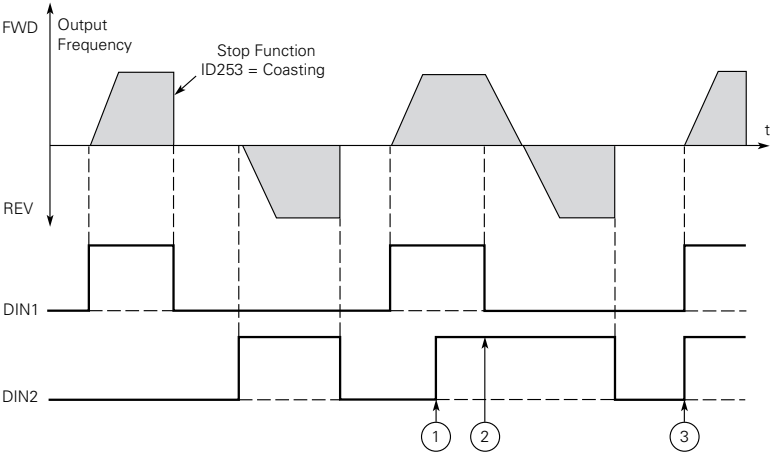
## Appendix A—Description of parameters

Modbus ID	Code	Parameters	Application	RO/RW
212	P3.39	<p><b>Motor Interlock 3</b></p> <p>Selects inputs allowed to verify aux motors are connected to allow them to run, if inputs are disabled drive will see this as a motor not connected an skip over the motor in the booster/auto-change sequence. When this function is set for Normally Open the drive will not see a motor interlock enabled when doing multi-pump and fan. If the function is set for Normally Close the drive will initialize that motors are connected to allow running. These are ideally tied to aux contacts on the output contactor to the motor. Can be set to DigiIN:X indicates on board terminal inputs, DigiIN:A:IOX:X indicates optional board inputs in A slot, DigiIN:B:IOX:X indicates optional board inputs in B slot, or Timer Channel X. RO X Function allows for having an input turn on without having to hard wire it to the physical relay output.</p> <p>Closed contact: motor interlock signal activated. Open contact: motor interlock signal unactivated.</p>	2, 3, 4	RW
213	P3.40	<p><b>Motor Interlock 4</b></p> <p>Selects inputs allowed to verify aux motors are connected to allow them to run, if inputs are disabled drive will see this as a motor not connected an skip over the motor in the booster/auto-change sequence. When this function is set for Normally Open the drive will not see a motor interlock enabled when doing multi-pump and fan. If the function is set for Normally Close the drive will initialize that motors are connected to allow running. These are ideally tied to aux contacts on the output contactor to the motor. Can be set to DigiIN:X indicates on board terminal inputs, DigiIN:A:IOX:X indicates optional board inputs in A slot, DigiIN:B:IOX:X indicates optional board inputs in B slot, or Timer Channel X. RO X Function allows for having an input turn on without having to hard wire it to the physical relay output.</p> <p>Closed contact: motor interlock signal activated. Open contact: motor interlock signal unactivated.</p>	2, 3, 4	RW
214	P3.41	<p><b>Motor Interlock 5</b></p> <p>Selects inputs allowed to verify aux motors are connected to allow them to run, if inputs are disabled drive will see this as a motor not connected an skip over the motor in the booster/auto-change sequence. When this function is set for Normally Open the drive will not see a motor interlock enabled when doing multi-pump and fan. If the function is set for Normally Close the drive will initialize that motors are connected to allow running. These are ideally tied to aux contacts on the output contactor to the motor. When this function is set for Normally Open the drive will not see a motor interlock enabled when doing multi-pump and fan. If the function is set for Normally Close the drive will initialize that motors are connected to allow running. These are ideally tied to aux contacts on the output contactor to the motor. Can be set to DigiIN:X indicates on board terminal inputs, DigiIN:A:IOX:X indicates optional board inputs in A slot, DigiIN:B:IOX:X indicates optional board inputs in B slot, or Timer Channel X. RO X Function allows for having an input turn on without having to hard wire it to the physical relay output.</p> <p>Closed contact: motor interlock signal activated. Open contact: motor interlock signal unactivated.</p>	2, 3, 4	RW
747	P3.42	<p><b>Ext Fault-AR</b></p> <p>Function disables the frequency converter from running the motor. Once this function is open the drive will stop on E-stop fault, when input closes drive will return to run with no reset required. If the function is set for Normally Open it will cause the drive to always have this function active. When set to Normally Closed the function will not be active and allow operation of the drive. Can be set to DigiIN:X indicates on board terminal inputs, DigiIN:A:IOX:X indicates optional board inputs in A slot, DigiIN:B:IOX:X indicates optional board inputs in B slot, or Timer Channel X. RO X Function allows for having an input turn on without having to hard wire it to the physical relay output. This input will automatically reset once the input is closed.</p> <p>Contact Open: Disables the ability for the motor to Run. Contact Close: Enables the ability for the motor to Run.</p>	1, 2, 3, 4	RW
1246	P3.43	<p><b>Bypass Overload</b></p> <p>Function faults frequency converter when using an external overload block, the relay would be fed into this input to fault the drive. When the function is set for Normally Open the drive will not go into the fault state, if it is set for Normally Closed the drive will go into this fault state and stay even if reset is applied. Input needs to be low to allow operation. Can be set to DigiIN:X indicates on board terminal inputs, DigiIN:A:IOX:X indicates optional board inputs in A slot, DigiIN:B:IOX:X indicates optional board inputs in B slot, or Timer Channel X. RO X Function allows for having an input turn on without having to hard wire it to the physical relay output.</p> <p>Closed contact: motor is over load in bypass. Use TTF method to realize the above functions.</p>	2, 3, 4	RW

Modbus ID	Code	Parameters	Application	RO/RW
2119	P3.44	<b>Fire Mode Direction Invert</b> Function allows motor to run in reverse when in fire mode input is enabled. when the function is set for Normally Open and not in Fire mode the drive will run as normal, when the function is set for Normally Closed and the Fire Mode input is enabled the motor will spin in the counter clockwise direction. DigilN:X indicates on-board terminal inputs, DigilN:A:IOX:X indicates optional board inputs in A slot and DigilN:B:IOX:X indicates optional board inputs in B slot or Timer Channel X. RO X Function allows for having an input turn on without having to hard wire it to the physical relay output.	2, 3, 4	RW

2206	P3.45	<b>IO Terminal 2 Start Stop Logic</b> For the DI function, we use Terminal programming method to function (TTF), you have a fixed input or output for which you define a certain function. 0 = P3.46 DI closed contact = start forward: P3.47 DI closed contact = start reverse. This would be considered 2 wire control with either a contact used on the Start FWD or Start REV commands = contacts open and the motor stops.	1, 2, 3, 4	RW
------	-------	---	------------	----

**Figure 65. Start forward/start reverse.**



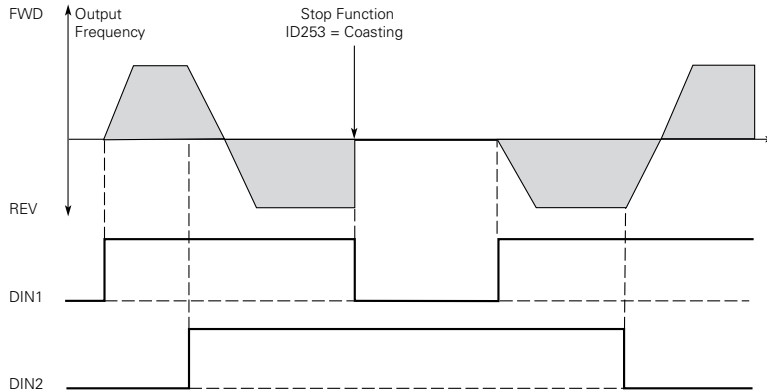
1 = P3.46: DI closed contact = start /open contact = stop P3.47: DI closed contact = reverse / open contact = forward - This would be considered 2 wire control with a contact on start/stop, contact open it stops and direction on 2nd start signal.

- NOTES:**
- ① The first selected direction has the highest priority.
  - ② When the DIN1 contact opens the direction of rotation starts to change.
  - ③ If Start forward (DIN1) and Start reverse (DIN2) signals are active simultaneously the Start forward signal (DIN1) has priority.

## Appendix A—Description of parameters

Modbus ID	Code	Parameters	Application	RO/RW
2206	P3.45	<b>IO Terminal 2 Start Stop Logic, continued</b>	1, 2, 3, 4	RW

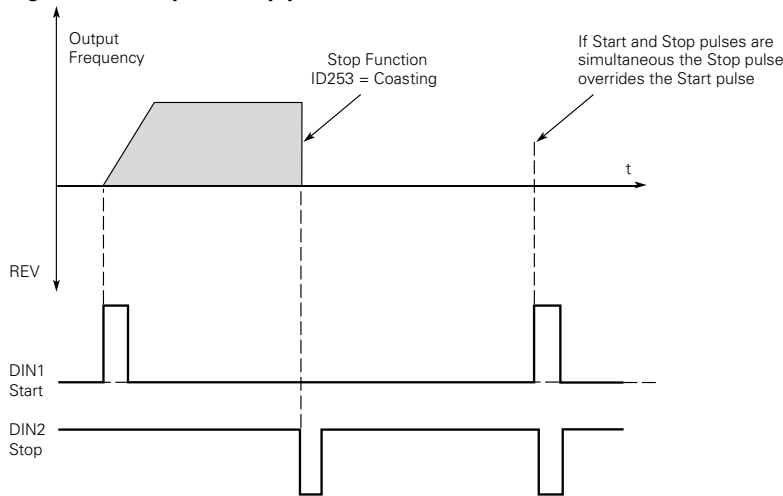
**Figure 66. Start, stop, and reverse.**



2 = P3.46: DI closed contact = start / open contact = stop P3.47: DI closed contact = start enabled / open contact = start disabled and drive stopped if running Motor direction keeps forward - This would be considered 3 wire control with Start signal 2 required to be closed to enable Start on Start signal 1.

3 = Three-wire connection (pulse control): P3.46: DI changes from open to closed = start pulse P3.47: DI changes from closed to open = stop pulse P3.5: DI closed contact = reverse/ open contact = forward - This would be considered 3 wire control with Start Signal 1 being the Start Pulse and Start Signal 2 being the NC Stop.

**Figure 67. Start pulse/stop pulse.**



2207	P3.46	<b>IO Terminal 2 Start Signal 1</b>	1, 2, 3, 4	RW
------	-------	-------------------------------------	------------	----

The 2nd Signal selection 1 for the start/stop logic listed in P3.45. Can be set to DigilN:X indicates on board terminal inputs, DigilN:A:IOX:X indicates optional board inputs in A slot, DigilN:B:IOX:X indicates optional board inputs in B slot, or Timer Channel X. RO X Function allows for having an input turn on without having to hard wire it to the physical relay output.

2208	P3.47	<b>IO Terminal 2 Start Signal 2</b>	1, 2, 3, 4	RW
------	-------	-------------------------------------	------------	----

The 2nd Signal selection 2 for the start/stop logic listed in P3.45. Can be set to DigilN:X indicates on board terminal inputs, DigilN:A:IOX:X indicates optional board inputs in A slot, DigilN:B:IOX:X indicates optional board inputs in B slot, or Timer Channel X. RO X Function allows for having an input turn on without having to hard wire it to the physical relay output.

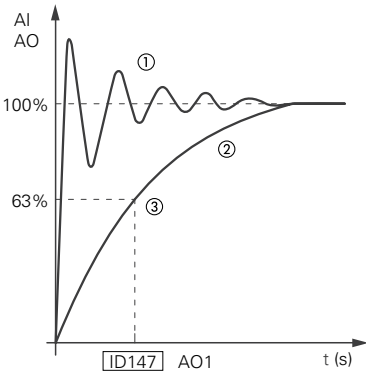
Modbus ID	Code	Parameters	Application	RO/RW
2293	P3.48	<p><b>Ext. Fault 2 NO</b></p> <p>Allows for external input causing drive to fault. This function is defined as NO so the function activates on a closed contact. If this function is assigned to Normally Open - the function is always off so the drive will not fault, when set to Normally Closed the function will be active and fault all the time. The additional settings allow assigning them to an input to control the function. Can be set to DigilN:X indicates on board terminal inputs, DigilN:A:IOX:X indicates optional board inputs in A slot, DigilN:B:IOX:X indicates optional board inputs in B slot, or Timer Channel X. RO X Function allows for having an input turn on without having to hard wire it to the physical relay output. The description on the fault can be changed in P3.53.</p> <p>Closed contact = external fault. Open contact = no external fault.</p>	1, 2, 3, 4	RW
2294	P3.49	<p><b>Ext. Fault 2 NC</b></p> <p>Allows for external input causing drive to fault. This function is defined as NC, so the function activates on a open contact. If this function is assigned to Normally Closed - the function is always on so the drive will not fault. When set to Normally Open, the function will be active and fault all the time. The additional settings allow assigning them to an input to control the function. Can be set to DigilN:X indicates on board terminal inputs, DigilN:A:IOX:X indicates optional board inputs in A slot, DigilN:B:IOX:X indicates optional board inputs in B slot, or Timer Channel X. RO X Function allows for having an input turn on without having to hard wire it to the physical relay output. The description on the fault can be changed in P3.53.</p> <p>Closed contact = no external fault. Open contact = external fault.</p>	1, 2, 3, 4	RW
2295	P3.50	<p><b>Ext. Fault 3 NO</b></p> <p>Allows for external input causing drive to fault. This function is defined as NO so the function activates on a closed contact. If this function is assigned to Normally Open, the function is always off so the drive will not fault. When set to Normally Closed, the function will be active and fault all the time. The additional settings allow assigning them to an input to control the function. Can be set to DigilN:X indicates on board terminal inputs, DigilN:A:IOX:X indicates optional board inputs in A slot, DigilN:B:IOX:X indicates optional board inputs in B slot, or Timer Channel X. RO X Function allows for having an input turn on without having to hard wire it to the physical relay output. The description on the fault can be changed in P3.54.</p> <p>Closed contact = external fault. Open contact = no external fault.</p>	1, 2, 3, 4	RW
2296	P3.51	<p><b>Ext. Fault 3 NC</b></p> <p>Allows for external input causing drive to fault. This function is defined as NC so the function activates on a open contact. If this function is assigned to Normally Closed, the function is always on so the drive will not fault. When set to Normally Open, the function will be active and fault all the time. The additional settings allow assigning them to an input to control the function. Can be set to DigilN:X indicates on board terminal inputs, DigilN:A:IOX:X indicates optional board inputs in A slot, DigilN:B:IOX:X indicates optional board inputs in B slot, or Timer Channel X. RO X Function allows for having an input turn on without having to hard wire it to the physical relay output. The description on the fault can be changed in P3.54.</p> <p>Closed contact = no external fault. Open contact = external fault.</p>	1, 2, 3, 4	RW

## Appendix A—Description of parameters

Modbus ID	Code	Parameters	Application	RO/RW
2297	P3.52	<p><b>Ext. Fault 1 Text</b></p> <p>Defines the text to be displayed when external Fault 1 NO or NC is triggered. This text will be viewable using a remote keypad, PowerXpert inControl, or the built in webserver.</p> <p>0 = External fault            1 = Vibration cut out            2 = High motor temp            3 = Low pressure            4 = High pressure            5 = Low water            6 = Damper interlock            7 = Run enable            8 = Freeze stat trip            9 = Smoke detect            10 = Seal leakage            11 = Rod breakage</p>	1, 2, 3, 4	RW
2298	P3.53	<p><b>Ext. Fault 2 Text</b></p> <p>Defines the text to be displayed when external Fault 2 NO or NC is triggered. This text will be viewable using a remote keypad, PowerXpert inControl, or the built in webserver.</p> <p>See Par ID 2297.</p>	1, 2, 3, 4	RW
2299	P3.54	<p><b>Ext. Fault 3 Text</b></p> <p>Defines the text to be displayed when external Fault 3 NO or NC is triggered. This text will be viewable using a remote keypad, PowerXpert inControl, or the built in webserver.</p> <p>See Par ID 2297.</p>	1, 2, 3, 4	RW
2312	P3.55	<p><b>Parameter Set1/2 Sel</b></p> <p>Allows for the drive to select between the stored parameter set1 or set2. This requires saving parameters to the stored sets parameter set (P21.1.3). When the function is set for Normally Open, the drive will use the standard Parameter Set 1 in the keypad. If the function is set for Normally Closed, the drive will follow Parameter Set 2 setting when stored to the keypad. DigiIN:A:IOX:X indicates optional board inputs in A slot, DigiIN:B:IOX:X indicates optional board inputs in B slot, or Timer Channel X. RO X Function allows for having an input turn on without having to hard wire it to the physical relay output.</p>	1, 2, 3, 4	RW
2394	P3.56	<p><b>Deragging Enable</b></p> <p>When Deragging Enable is Enabled it will allow the drive to cycle the motor forward and reverse for 3 cycles, this would be used to remove any jamming on start. If the function is set for Normally Open, the deragging function will not be activated. If the function is set for Normally Closed, then the Derag Function will always be active. Can be set to DigiIN: X indicates on board terminal inputs, DigiIN:A:IOX:X indicates option boards in A slot, DigiIN:B:IOX:X indicates optional board in B slot, or Timer Channel X. RO X function allows for having an input to run on without having to hard wire it to the physical relay output.</p>	2, 3, 4	RW
2395	P3.57	<p><b>HOA On/Off</b></p> <p>HOA off control allows for disabling any control signal when the input is the off/open position, when closed drive will follow the desired control signal. If the function is set for Normally Open, this will cause the drive to operate. If the function is set for Normally Closed, then the drive will be in the off location and not allow operation. Can be set to DigiIN: X indicates on board terminal inputs, DigiIN:A:IOX:X indicates option boards in A slot, DigiIN:B:IOX:X indicates optional board in B slot, or Timer Channel X. RO X function allows for having an input to run on without having to hard wire it to the physical relay output.</p>	1, 2, 3, 4	RW
2658	P3.58	<p><b>Multi-pump Mode 1/2 Select</b></p> <p>DI function selection parameter. It will select MPFC use parameter MFC mode or MFC mode2. User could switch the pump mode between MFC mode and MFC mode2 by DI.</p>	2, 3, 4	RW

Modbus ID	Code	Parameters	Application	RO/RW
2801	P3.59	<b>OP Cont Interlock NO</b> Allows for Output Contactor Interlock input causing drive to fault if drive in run mode and has a time delay of 250 ms. This function is defined as NO so the function activates on a closed contact. If this function is assigned to Normally Open, the function is always off so the drive will not fault. When set to Normally Closed, the function will be active and fault all the time if run drive. The additional settings allow assigning them to an input to control the function. Different Settings DigilN:X indicates on board terminal inputs, DigilN:A:IOX:X indicates optional board inputs in A slot, DigilN:B:IOX:X indicates optional board inputs in B slot, or Timer Channel X. RO X Function allows for having an input turn on without having to hard wire it to the physical relay output.	1, 2, 3, 4	RW
2802	P3.60	<b>OP Cont Interlock NC</b> Allows for Output Contactor Interlock input causing drive to fault if drive in run mode and has a time delay of 250 ms. This function is defined as NC so the function activates on an open contact. If this function is assigned to Normally Closed, the function is always off so the drive will not fault. When set to Normally Open, the function will be active and fault all the time if run drive. The additional settings allow assigning them to an input to control the function. Different Settings DigilN:X indicates on board terminal inputs, DigilN:A:IOX:X indicates optional board inputs in A slot, DigilN:B:IOX:X indicates optional board inputs in B slot, or Timer Channel X. RO X Function allows for having an input turn on without having to hard wire it to the physical relay output.	1, 2, 3, 4	RW
2894	P3.61	<b>CP Interlock NC</b> CP interlock DI NC select.	1, 2, 3, 4	RW
227	P4.1	<b>A01 Mode</b> Defines the analog output mode to current or voltage. There are internal relays to perform the switching of the signal between mA or V.	1, 2, 3, 4	RW
146	P4.2	<b>A01 Function</b> Select the function desired to the terminal A01 terminal 22.	1, 2, 3, 4	RW
149	P4.3	<b>A01 Minimum</b> Defines the signal minimum to be either 0 mA or 4 mA (A01 mode = 0–20 mA); 0 V or 2 V (A01 mode = 0–10 V). 0 = Set minimum value to 0 V/0 mA. 1 = Set minimum value to 2 V/4 mA.	1, 2, 3, 4	RW
147	P4.4	<b>A01 Filter Time</b> Defines the filter time applied to the analog output signal. Zero equals no filtering.	1, 2, 3, 4	RW

Figure 68. Analog output filtering.



- Notes**
- ① Unfiltered analog signal.
  - ② Filtered analog signal.
  - ③ Filter time constant at 63% of the set value.

## Appendix A—Description of parameters

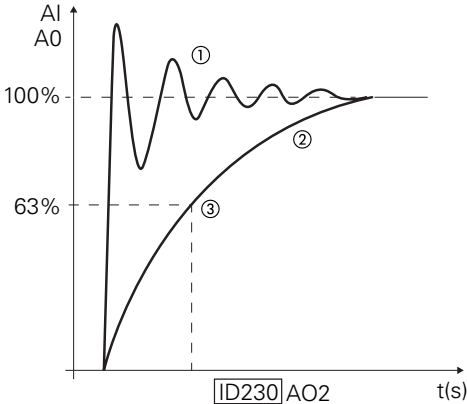
Modbus ID	Code	Parameters	Application	RO/RW
150	P4.5	<p><b>A01 Scale</b></p> <p>Scaling factor for analog output function from 10% to 1000%. In adjusting this value, it will either extend or shrink the scale on the analog signal from 0–10 V/0–20 mA or 2–10 V/4–20 mA.</p> <p><b>Figure 69. Analog output scaling.</b></p>	1, 2, 3, 4	RW
148	P4.6	<p><b>A01 Inversion</b></p> <p>Inverts the analog output signal, normally 0 V/0 mA/2 V/4 mA = 0% and 10 V/20 mA = 100%, when inverted 0 V/0 mA/2 V/4 mA = 100% and 10 V/20 mA = 0%:            Maximum output signal = Minimum set value.            Minimum output signal = Maximum set value.</p> <p><b>Figure 70. Analog output invert.</b></p>	1, 2, 3, 4	RW
173	P4.7	<p><b>A01 Offset</b></p> <p>Add –100.0 to 100.0% to the analog output minimum value to add in an additional offset scale factor.</p>	1, 2, 3, 4	RW
228	P4.8	<p><b>A02 Mode</b></p> <p>Selects the analog output mode for A02 as current or voltage. There are internal relays to perform the switching of the signal between mA or V.</p>	1, 2, 3, 4	RW
229	P4.9	<p><b>A02 Function</b></p> <p>Selects the desired function for the A02 terminal 24.</p>	1, 2, 3, 4	RW
232	P4.10	<p><b>A02 Minimum</b></p> <p>Defines the signal minimum to be either 0 mA or 4 mA (A01 mode = 0–20 mA);            0 V or 2 V (A01 mode = 0–10 V).            0 = Set minimum value to 0 V/0 mA.            1 = Set minimum value to 2 V/4 mA.</p>	1, 2, 3, 4	RW



Modbus ID	Code	Parameters	Application	RO/RW
230	P4.11	<b>A02 Filter Time</b>	1, 2, 3, 4	RW

Defines the filtering time for the analog output signal, with a higher number the more filtering time is added on the output signal. Setting this parameter value to 0.00 will deactivate filtering.

**Figure 71. AO2 filter time.**

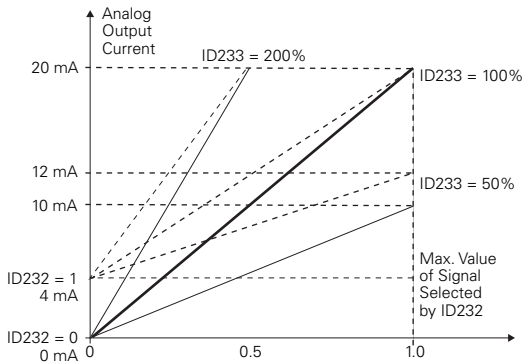


- Notes:**
- ① Unfiltered analog signal.
  - ② Filtered analog signal.
  - ③ Filter time constant at 63% of the set value.

233	P4.12	<b>A02 Scale</b>	1, 2, 3, 4	RW
-----	-------	------------------	------------	----

Scaling factor for analog output function from 10% to 1000%. In adjusting this value, it will either extend or shrink the scale on the analog signal from 0–10 V/0–20 mA or 2–10 V/4–20 mA.

**Figure 72. Analog output scaling.**



231	P4.13	<b>A02 Inversion</b>	1, 2, 3, 4	RW
-----	-------	----------------------	------------	----

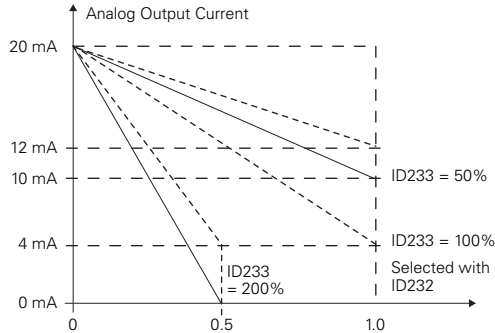
Inverts the analog output signal, normally 0 V/0 mA/2 V/4 mA = 0% and 10 V/20 mA = 100%, when inverted 0 V/0m A/2 V/4 mA = 100% and 10 V/20 mA = 0%:  
 Maximum output signal = Minimum set value.  
 Minimum output signal = Maximum set value.

## Appendix A—Description of parameters

Modbus ID	Code	Parameters	Application	RO/RW
234	P4.14	<b>A02 Offset</b>	1, 2, 3, 4	RW

Add -100.0 to 100.0% to the analog output minimum value to add in an additional offset scale factor.

**Figure 73. Analog output invert.**



151	P5.1	<b>D01 Function</b>	1, 2, 3, 4	RW
-----	------	---------------------	------------	----

Defines the function associated with changing the state of relay output1:

- 0 = Not used - No action
- 1 = Ready - Drive is ready for operation
- 2 = Run - Drive is running
- 3 = Fault - Drive is faulted
- 4 = Fault invert - Drive is not faulted
- 5 = Warning - Drive has a warning message
- 6 = Reverse - Drive is outputting reverse phase rotation
- 7 = At speed - The output frequency has reached the set reference
- 8 = Zero frequency - Drive output is at zero frequency
- 9 = Frequency limit supervision - Supervision for frequency limit 1 is activated
- 10 = PIDsupervision - Supervision for PIDcontroller is activated
- 11 = Torque limit supervision - Supervision for torque limit
- 12 = Reference limit supervision - Supervision for reference limit
- 13 = Power limit supervision - Supervision for power limit
- 14 = Temp limit supervision - Supervision for drive temperature limit
- 15 = Analog input supervision - Supervision for analog input limit
- 16 = Motor current supervision - Supervision for motor current limit
- 17 = Over heat fault - Drive over heat fault has occurred
- 18 = Over current regular - Over current regulator is enabled
- 19 = Over volt regular - Over volt regulator is enabled
- 20 = Under volt regular - Under volt regulator is enabled
- 21 = 4 mA fault - 4 mA fault has occurred
- 22 = External fault - External fault has occurred
- 23 = Motor thermal fault - Motor thermal fault has occurred
- 24 = STO fault output - Safe Torque Off input is activated
- 25 = Control from IO - I/O is the selected start command location
- 26 = Remote control - Remote is the control place
- 27 = Un-requested rotation direction - The active direction isn't the same as the reference direction
- 28 = Fire mode - Drive is in fire mode
- 29 = Damper control - Damper control output
- 30 = Valve control - Valve control output
- 31 = Jog speed - Drive is in jog mode
- 32 = Fieldbus input1 - Controlled by FB control word
- 33 = Fieldbus input2 - Controlled by FB control word
- 34 = DC charge switch close - DC precharge relay is closed
- 35 = Preheat active - Preheat control mode is activated
- 36 = Cold weather active - Cold weather mode is active

Modbus ID	Code	Parameters	Application	RO/RW
151	P5.1	<p><b>D01 Function, continued</b></p> <p>Setting Value Signal Content</p> <p>37 = PIDsleep - PIDcontroller is in a sleep state</p> <p>38 = 2nd stage ramp frequency active - Accel/Decel time 2 is active</p> <p>39 = Prime pump active - Drive is running in prime pump mode</p> <p>40 = Master drive state - Indicates if the master drive in the multi-pump control mode is faulted</p> <p>41 = Temperature limit supervision - Supervision for temperature limit</p> <p>42 = Analog input supervision - Supervision for analog input</p> <p>43 = Motor1 control - Motor1 is controlled</p> <p>44 = Motor2 control - Motor2 is controlled</p> <p>45 = Motor3 control - Motor3 is controlled</p> <p>46 = Motor4 control - Motor4 is controlled</p> <p>47 = Motor5 control - Motor5 is controlled</p> <p>48 = Logic fulfilled - The status of logic function</p> <p>49 = PID1 sleep - PID1 controller is in sleep mode</p> <p>50 = PID2 sleep - PID2 controller is in sleep mode</p> <p>51 = Motor current 1 Supv - Motor current supervision value active</p> <p>52 = Motor current 2 Supv - Motor current supervision value active</p> <p>53 = Second AI limit Supv - Analog input supervision active</p> <p>54 = DC charge switch close - DC bus is charged (230 Vac - 230 Vdc, 480 Vac - 380 Vdc, 575 Vac - 520 Vdc) fault signal is not effected by this output.</p> <p>55 = Preheat active - Preheat control mode is activated</p> <p>56 = Cold weather active - Cold weather mode is activated</p> <p>57 = Pre-charge active - Pre-charge resistor is active</p> <p>58 = 2nd stage ramp frequency active - 2nd stage ramp frequency limit reached</p> <p>59 = STO fault output - STO fault is active</p> <p>60 = Run bypass/drive - Run indication for drive and bypass</p> <p>61 = Bypass overload</p> <p>62 = Bypass run</p> <p>63 = Auto local on COM fault</p> <p>64 = FieldBus RTU fault</p> <p>65 = FieldBus TCP fault</p> <p>66 = FieldBus MSTP fault</p> <p>67 = FieldBus EIP fault</p> <p>68 = FieldBus SlotA fault</p> <p>69 = FieldBus SlotB fault</p> <p>70 = FieldBus SWD fault</p> <p>71 = Jockey pump active</p> <p>72 = Lube pump active</p> <p>73 = PID1 low feedback</p> <p>74 = PID1 high feedback</p> <p>75 = PID2 low feedback</p> <p>76 = PID2 high feedback</p> <p>77 = Master in MPFC</p> <p>78 = CP interlock fault.</p>	1, 2, 3, 4	RW
152	P5.2	<p><b>R01 Function</b></p> <p>Defines the Function associated with changing the state of relay output1. See Par ID 151.</p>	1, 2, 3, 4	RW
153	P5.3	<p><b>R02 Function</b></p> <p>Defines the function associated with changing the state of relay output2. See Par ID 151.</p>	1, 2, 3, 4	RW
538	P5.4	<p><b>R03 Function</b></p> <p>Defines the Function associated with changing the state of relay output3. See Par ID 151.</p>	1, 2, 3, 4	RW

## Appendix A—Description of parameters

Modbus ID	Code	Parameters	Application	RO/RW
2463	P5.5	<b>Virtual R01 Function</b> Defines the Function associated with changing the state of relay R01. See Par ID 151.	1, 2, 3, 4	RW
2464	P5.6	<b>Virtual R02 Function</b> Defines the function associated with changing the state of relay R02. See Par ID 151.	1, 2, 3, 4	RW
154	P5.7	<b>Freq Limit 1 Supv</b> Selects how the drive's frequency limit supervision controller functions. If the output frequency goes under/over the set limit (P5.8), this function generates a warning message via the digital output DO1 or relay outputs RO1, RO2, or RO3, depending on the settings of P5.1 to P5.2, P5.3, and P5.4. 0 = No supervision 1 = Low limit supervision 2 = High limit supervision 3 = Brake-on control (Application 4 only).	1, 2, 3, 4	RW
155	P5.8	<b>Freq Limit 1 Supv Val</b> Selects the frequency value supervised by the frequency limit supervision function (P5.7). <b>Figure 74. Supervision function.</b>	1, 2, 3, 4	RW
157	P5.9	<b>Freq Limit 2 Supv</b> Selects how the drives frequency limit supervision controller functions. Selects how the drives frequency limit supervision controller functions. If the output frequency goes under/over the set limit (P5.10), this function generates a warning message via the digital output DO1 or relay outputs RO1, RO2, or RO3, depending on the settings of P5.1 to P5.2, P5.3, and P5.4. 0 = No supervision 1 = Low limit supervision 2 = High limit supervision 3 = Brake-on control (Application 4 only) 4 = Brake-on/off control (Application 4 only).	1, 2, 3, 4	RW
158	P5.10	<b>Freq Limit 2 Supv Val</b> Defines the frequency value supervised by the frequency limit supervision function (P5.9).	1, 2, 3, 4	RW

Modbus ID	Code	Parameters	Application	RO/RW
159	P5.11	<p><b>Torque Limit Supv</b></p> <p>Selects how the drives torque limit supervision controller functions. If the output torque goes under/over the set limit (P5.12), this function generates a warning message via the digital output DO1 or via the relay outputs R01, R02, or R03, depending on the settings of P5.1 to P5.2, P5.3, and P5.4. It can also control a mechanical brake to disable once torque is built up with the motor (Torque proofing).</p> <p>0 = No limit                      1 = Low limit supervision                      2 = High limit supervision                      3 = Brake-off control (Application 4 only).</p> <p><b>Figure 75. Supervision function.</b></p>	1, 2, 3, 4	RW
160	P5.12	<p><b>Torque Limit Supv Val</b></p> <p>Defines the torque value supervised by the torque limit supervision function (P5.11).</p>	1, 2, 3, 4	RW
161	P5.13	<p><b>Ref Limit Supv</b></p> <p>Selects how the drives reference limit supervision controller function. If the drivers reference goes under/over the set limit (P5.14), this function generates a warning message via the digital output DO1 or via the relay outputs R01, R02, or R03, depending on the settings of P5.1 to P5.2, P5.3, and P5.4.</p> <p>0 = No supervision                      1 = Low limit supervision                      2 = High limit supervision.</p>	1, 2, 3, 4	RW
162	P5.14	<p><b>Ref Limit Supv Val</b></p> <p>Defines the reference frequency value supervised by the reference frequency limit supervision function (P5.13).</p>	1, 2, 3, 4	RW
163	P5.15	<p><b>Ext Brake Off Delay</b></p> <p>The function of the external brake can be timed on or time off delay to provide ample time to enable and disable an external brake module.</p> <p>The brake control signal can be programmed via digital output DO1, or via one of the relay outputs R01, R02, and R03.</p> <p>a) Start/Stop logic selection, 0, 1, or 2.                      b) Start/Stop logic selection, 3.</p>	4	RW

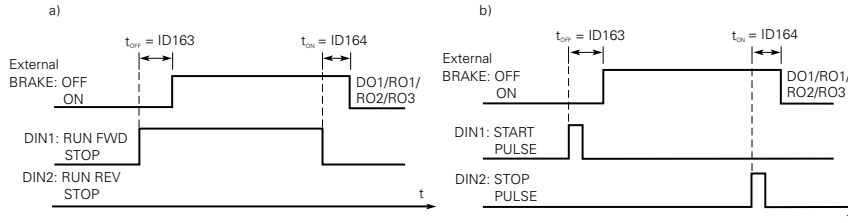
# Appendix A—Description of parameters

Modbus ID	Code	Parameters	Application	RO/RW
164	P5.16	<b>Ext Brake On Delay</b>	4	RW

The function of the external brake can be timed on or time off delay to provide ample time to enable and disable an external brake module.

The brake control signal can be programmed via digital output DO1, or via one of the relay outputs RO1, RO2, and RO3.

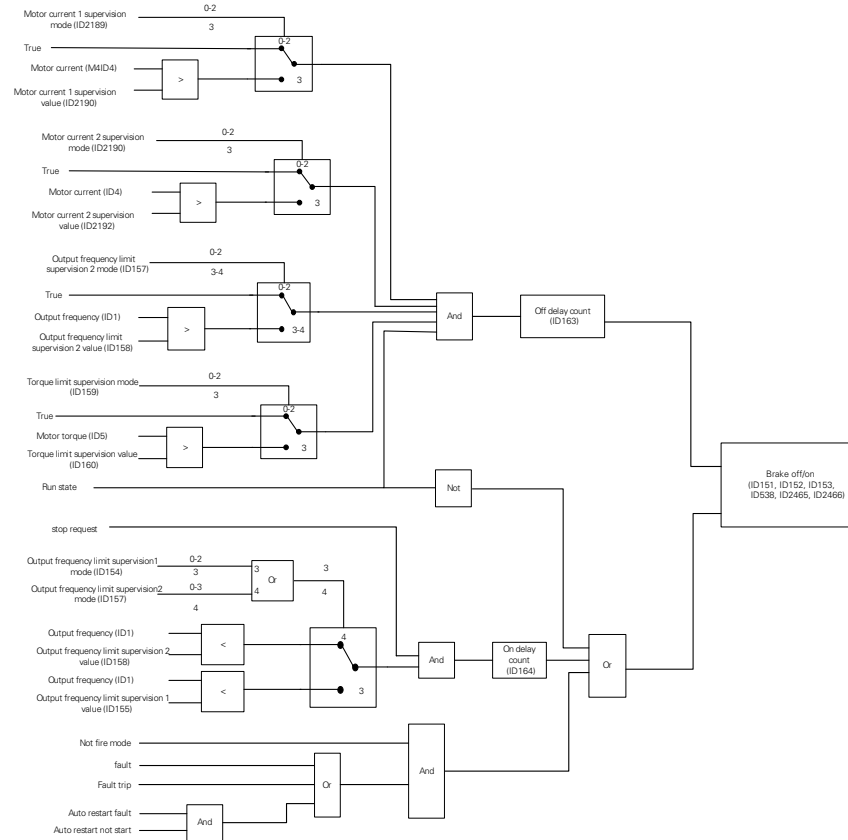
**Figure 76. External brake control.**



a) Start/Stop logic selection, 0, 1 or 2.

b) Start/Stop logic selection, 3

When using the brake control, the following table is used to demonstrate the control functions. Brake on delay should be set longer than the ramp time in order to avoid damaging the brake.



Modbus ID	Code	Parameters	Application	RO/RW
165	P5.17	<p><b>Temp Limit Supv</b></p> <p>Selects how the drives temperature limit supervision controller function. If the temperature of the frequency converter unit falls below or exceeds the set limit (P5.18), this function generates a warning message via the digital output DO1 or via a relay output RO1, RO2, or RO3, depending on the settings of P5.1 to P5.2, P5.3, and P5.4.</p> <p>0 = No supervision 1 = Low limit supervision 2 = High limit supervision.</p>	1, 2, 3, 4	RW
166	P5.18	<p><b>Temp Limit Supv Val</b></p> <p>Defines the drive temperature value supervised by the drive temperature limit supervision function (P5.17).</p>	1, 2, 3, 4	RW
167	P5.19	<p><b>Power Limit Supv</b></p> <p>Selects how the drives power limit supervision controller functions. If the calculated power value falls below or exceeds the set limit (P5.20), this function generates a warning message via the digital output DO1 or via a relay output RO1, RO2, or RO3, depending on the settings of P5.1 to P5.2, P5.3, and P5.4.</p> <p>0 = No supervision 1 = Low limit supervision 2 = High limit supervision.</p>	1, 2, 3, 4	RW
168	P5.20	<p><b>Power Limit Supv Val</b></p> <p>Defines the output power value supervised by the power limit supervision function (P5.19).</p>	1, 2, 3, 4	RW
170	P5.21	<p><b>AI Supv Select</b></p> <p>Selects analog signal to use for the analog input supervision.</p> <p>0 = Analog reference from AI. 1 = Analog reference from keypad potentiometer.</p>	1, 2, 3, 4	RW
171	P5.22	<p><b>AI Limit Supv</b></p> <p>Selects how the analog input limit supervision controller functions. If the value of the selected analog input goes under/over the set limit (P5.23), this function generates a warning message through the digital output or the relay outputs depending on the settings of P5.1 to P5.2, P5.3, and P5.4.</p> <p>0 = No supervision 1 = Low limit supervision 2 = High limit supervision.</p>	1, 2, 3, 4	RW
172	P5.23	<p><b>AI Limit Supv Val</b></p> <p>Defines the analog reference value supervised by the analog reference limit supervision function (P5.22).</p>	1, 2, 3, 4	RW
1346	P5.24	<p><b>PID1 Superv Enable</b></p> <p>Upper and lower limits around the reference are set. When the actual feedback value goes above the upper limit (P5.25) or below the upper limit (P5.26), and lower limit the delay timer will increment. When the actual value is within the allowed area, the delay counter decrements. After the delay time expires, the relay output for PIDsupervision will be activated. It will generate a warning message through the digital output or the relay outputs depending on the settings of P5.1 to P5.2, P5.3, and P5.4. This function is used for process value out of range faults.</p>	2, 3, 4	RW
1347	P5.25	<p><b>PID1 Superv Upper Limit</b></p> <p>Defines upper limit for PID feedback value used with the PID supervision controller.</p>	2, 3, 4	RW
1349	P5.26	<p><b>PID1 Superv Lower Limit</b></p> <p>Defines lower limit for PID feedback value used with the PID supervision controller.</p>	2, 3, 4	RW
1351	P5.27	<p><b>PID1 Superv Delay</b></p> <p>Defines the delay time that the PID feedback value must be out of range before activating the PID supervision output.</p>	2, 3, 4	RW
1408	P5.28	<p><b>PID2 Superv Enable</b></p> <p>Upper and lower limits around the reference are set. When the actual value goes above or below these, a counter starts counting up toward the Delay. When the actual value is within the allowed area, the same counter counts down instead. After the delay time it will turn on an relay output value. These can be fed into a digital input for pressure level faults.</p>	3, 4	RW

## Appendix A—Description of parameters

Modbus ID	Code	Parameters	Application	RO/RW
1409	P5.29	<b>PID2 Superv Upper Limit</b> Upper and lower limits around the reference are set. When the actual value goes above or below these, a counter starts counting up toward the Delay. When the actual value is within the allowed area, the same counter counts down instead. After the delay time it will turn on an relay output value. These can be fed into a digital input for pressure level faults.	3, 4	RW
1411	P5.30	<b>PID2 Superv Lower Limit</b> Upper and lower limits around the reference are set. When the actual value goes above or below these, a counter starts counting up toward the Delay. When the actual value is within the allowed area, the same counter counts down instead. After the delay time it will turn on an relay output value. These can be fed into a digital input for pressure level faults.	3, 4	RW
1413	P5.31	<b>PID2 Superv Delay</b> Upper and lower limits around the reference are set. When the actual value goes above or below these, a counter starts counting up toward the Delay. When the actual value is within the allowed area, the same counter counts down instead. After the delay time it will turn on an relay output value. These can be fed into a digital input for pressure level faults.	3, 4	RW
2112	P5.32	<b>RO1 On Delay</b> Delay time for RO1 relay to turn on after signal received.	1, 2, 3, 4	RW
2113	P5.33	<b>RO1 Off Delay</b> Delay time for RO1 relay to turn off after signal removed.	1, 2, 3, 4	RW
2114	P5.34	<b>RO2 On Delay</b> Delay time for RO2 relay to turn on after signal received.	1, 2, 3, 4	RW
2115	P5.35	<b>RO2 Off Delay</b> Delay time for RO2 relay to turn off after signal removed.	1, 2, 3, 4	RW
2116	P5.36	<b>RO3 On Delay</b> Delay time for RO3 relay to turn on after signal received.	1, 2, 3, 4	RW
2117	P5.37	<b>RO3 Off Delay</b> Delay time for RO3 relay to turn off after signal removed.	1, 2, 3, 4	RW
2118	P5.38	<b>RO3 Reverse</b> Inverts the output function of RO3 to be normally closed. Instead of normally open, on the Form A relay.	1, 2, 3, 4	RW
2189	P5.39	<b>Motor Current 1 Supv</b> Selects how the motor current limit supervision controller functions. If the motor current goes under/over the set limit (P5.40), this function generates a warning message through the digital output or the relay outputs, depending on the settings of P5.1 to P5.2, P5.3, and P5.4. 0 = No supervision 1 = Low limit supervision 2 = High limit supervision 3 = Brake Off Control (Application 4 only).	1, 2, 3, 4	RW
2190	P5.40	<b>Motor Current 1 Supv Value</b> Defines the motor current value supervised by the motor current limit supervision function (P5.39).	1, 2, 3, 4	RW
2191	P5.41	<b>Motor Current 2 Supv</b> Selects how the motor current limit supervision controller functions. If the motor current goes under/over the set limit (P5.42), this function generates a warning message through the digital output or the relay outputs, depending on the settings of P5.1 to P5.2, P5.3, and P5.4. 0 = No supervision 1 = Low limit supervision 2 = High limit supervision 3 = Brake off control (Application 4 only).	1, 2, 3, 4	RW
2192	P5.42	<b>Motor Current 2 Supv Value</b> Defines the motor current value supervised by the motor current limit supervision function (P5.41).	1, 2, 3, 4	RW
2193	P5.43	<b>Second AI Supv Select</b> Selects analog signal to use for the analog input supervision. 0 = Analog reference from AI. 1 = Analog reference from keypad potentiometer.	1, 2, 3, 4	RW



Modbus ID	Code	Parameters	Application	RO/RW
2194	P5.44	<b>Second AI Limit Supv</b> Selects how the analog input limit supervision controller functions. If the value of the selected analog input goes under/over the set limit (P5.45), this function generates a warning message through the digital output or the relay outputs, depending on the settings of P5.1 to P5.2, P5.3, and P5.4. 0 = No supervision 1 = Low limit supervision 2 = High limit supervision.	1, 2, 3, 4	RW
2195	P5.45	<b>Second AI Limit Supv Val</b> Defines the analog reference value supervised by the analog reference limit supervision function (P5.44).	1, 2, 3, 4	RW
2196	P5.46	<b>Motor Current 1 Supv Hyst</b> This value defines the bandwidth between when the motor current 1 supervision enables and disables.	1, 2, 3, 4	RW
2197	P5.47	<b>Motor Current 2 Supv Hyst</b> This value defines the bandwidth between when the motor current 2 supervision enables and disables.	1, 2, 3, 4	RW
2198	P5.48	<b>AI Supv Hyst</b> This value defines the bandwidth between when the AI supervision enables and disables.	1, 2, 3, 4	RW
2199	P5.49	<b>Second AI Supv Hyst</b> This value selects the bandwidth between when the second AI supervision enables and disables.	1, 2, 3, 4	RW
2200	P5.50	<b>Freq Limit 1 Supv Hyst</b> This value defines the bandwidth between when the output frequency Limit 1 supervision enables and disables.	1, 2, 3, 4	RW
2201	P5.51	<b>Freq Limit 2 Supv Hyst</b> This value defines the bandwidth between when the output frequency Limit 2 supervision enables and disables.	1, 2, 3, 4	RW
2202	P5.52	<b>Torque Limit Supv Hyst</b> This value defines the bandwidth between when the torque limit supervision enables and disables.	1, 2, 3, 4	RW
2203	P5.53	<b>Ref Limit Supv Hyst</b> This value defines the bandwidth between when the reference limit supervision enables and disables.	1, 2, 3, 4	RW
2204	P5.54	<b>Temp Limit Supv Hyst</b> This value defines the bandwidth between when the temp limit supervision enables and disables.	1, 2, 3, 4	RW
2205	P5.55	<b>Power Limit Supv Hyst</b> This value defines the bandwidth between when the power limit supervision enables and disables.	1, 2, 3, 4	RW
2848	P5.56	<b>Virtual R01 On Delay</b> Delay time for virtual R01 relay to turn on after signal received.	1, 2, 3, 4	RW
2849	P5.57	<b>Virtual R01 Off Delay</b> Delay time for virtual R01 relay to turn off after signal removed.	1, 2, 3, 4	RW
2850	P5.58	<b>Virtual R02 On Delay</b> Delay time for virtual R02 relay to turn on after signal received.	1, 2, 3, 4	RW
2851	P5.59	<b>Virtual R02 Off Delay</b> Delay time for virtual R02 relay to turn off after signal removed.	1, 2, 3, 4	RW
751	P6.1	<b>Logic Function Select</b> The logic function enables you to link both parameters logic function input(A) (P6.2) and logic function input (B) (P6.3) logically with each other. The value can be: And - indicating both being active then enable the logic, OR - if one or both inputs are active then it will enable the logic, XOR - if any one of the inputs are active the logic is enabled. If both logics are the same state, it disables the logic. The result (LOG) can then be assigned to the digital outputs DO, RO1, RO2, and RO3. The type of operation is defined in parameter logic function selection (P6.1): 0 = AND 1 = OR 2 = XOR	4	RW
752	P6.2	<b>Logic Operation Input A</b> Input A for Logic function calculation defined in P6.1. See P5.1 DO/RO Functions for settings.	4	RW

## Appendix A—Description of parameters

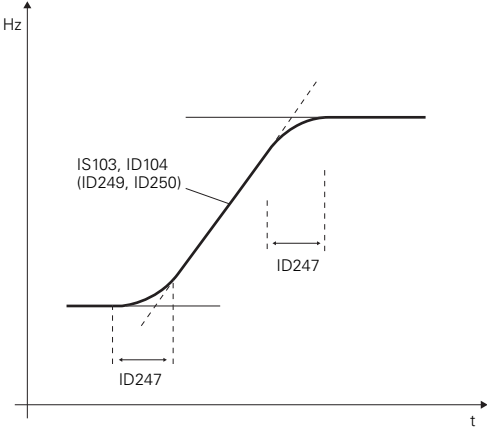
Modbus ID	Code	Parameters	Application	RO/RW
753	P6.3	<b>Logic Operation Input B</b> Input B for Logic function calculation defined in P6.1. See P5.1 DO/RO Functions for settings.	4	RW
138	P7.1	<b>Remote 2 Control Place</b> Selects where the drive will look for the 2nd start command, I/O terminals would be from the Digital hardwired inputs, Fieldbus would be a communication bus. Keypad will indicate what mode is selected. Digital input will select between control place 1 and control place 2.	1, 2, 3, 4	RW
139	P7.2	<b>Remote 2 Reference</b> Selects what frequency reference source to look at when in the Remote 2 control mode.	1, 2, 3, 4	RW
141	P7.3	<b>Keypad Reference</b> Keypad Reference value.	1, 2, 3, 4	RW
116	P7.4	<b>Keypad Direction</b> 0 = Forward: The rotation of the motor is forward or clockwise direction, when the keypad is the active control place. 1 = Reverse: The rotation of the motor is reversed or counter clockwise direction, when the keypad is the active control place.	1, 2, 3, 4	RW
114	P7.5	<b>Keypad Stop</b> 0 = Enabled-Keypad operation - In this mode, the keypad stop will only operate when the control source is set to keypad. 1 = Always Enables - In this mode, the stop button will always stop the drive regardless of control mode.	1, 2, 3, 4	RW
117	P7.6	<b>Jog Reference</b> Defines the jogging speed set point. This speed is selected with the digital input programmed for Jogging speed. When DI is enabled, the drive starts and ramps to this speed. When DI is removed, the drive stops. This parameter's value is automatically limited between minimum and maximum frequency (P1.1.1 and P1.1.2).	1, 2, 3, 4	RW
156	P7.7	<b>Motor Pot Ramp Time</b> Defines the speed of change for the motor potentiometer reference value.	4	RW
169	P7.8	<b>Motor Pot Ref Reset</b> Defines how the motor pot reference signal is handled on shutting down frequency converter output or powering down the frequency converter. 0 = No reset - Reference stays at last setting. 1 = Memory reset in stop and power down - Reference resets to 0 when drive is stopped or the power is cycled to the drive. 2 = Memory reset in power down - Reference resets to 0 when drive is powered down only.	4	RW
252	P7.9	<b>Start Mode</b> 0 = Ramp - The drive starts from 0 Hz and ramps to the frequency reference value. 1 = Flying start from stop frequency - The drive will catch a spinning motor. This setting searches for the current frequency using the last operating frequency as a starting point. 2 = Flying start from max. frequency - The drive will catch a spinning motor. This setting searches for the current frequency using the maximum operating frequency as a starting point.	1, 2, 3, 4	RW
253	P7.10	<b>Stop Mode</b> 0 = Coasting - After a stop command, the motor coasts to a stop uncontrolled by the drive. 1 = Ramp - After the stop command, the speed of the motor is decelerated according to the set deceleration parameters.	1, 2, 3, 4	RW

Modbus ID	Code	Parameters	Application	RO/RW
247	P7.11	<b>Ramp 1 Shape</b>	1, 2, 3, 4	RW

The start and end of the acceleration and deceleration ramps can be smoothed with these parameters. Setting a value of 0.0 gives a linear ramp shape that causes acceleration and deceleration to react immediately to the changes in the reference signal.

Setting a value from 0.1 to 10 seconds for this parameter produces an S-shaped acceleration/ deceleration at the start and stop of the slope. The acceleration time is determined with P1.3 and P1.4, or P7.13 and P7.14.

**Figure 77. Acceleration/deceleration (S-shaped).**

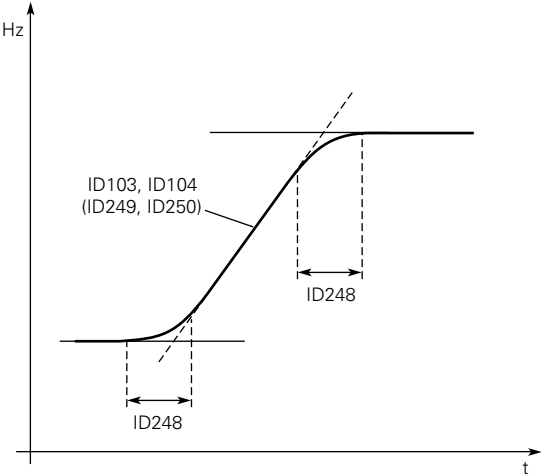


248	P7.12	<b>Ramp 2 Shape</b>	1, 2, 3, 4	RW
-----	-------	---------------------	------------	----

The start and end of the acceleration and deceleration ramps can be smoothed with these parameters. Setting a value of 0.0 gives a linear ramp shape that causes acceleration and deceleration to react immediately to the changes in the reference signal.

Setting a value from 0.1 to 10 seconds for this parameter produces an S-shaped acceleration/ deceleration at the start and stop of the slope. The acceleration time is determined with P1.3 and P1.4, or P7.13 and P7.14.

**Figure 78. Acceleration/deceleration (S-shaped).**



249	P7.13	<b>Accel Time 2</b>	1, 2, 3, 4	RW
-----	-------	---------------------	------------	----

These values correspond to the time required for the output frequency to accelerate from the zero frequency to the set maximum frequency (P1.2).

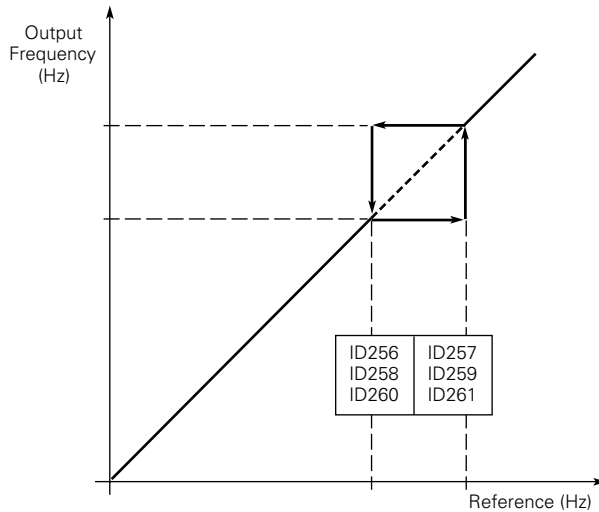
These parameters provide the possibility to set two different acceleration/deceleration time sets for one application.

The active set can be selected with the programmable digital input.

## Appendix A—Description of parameters

Modbus ID	Code	Parameters	Application	RO/RW
250	P7.14	<b>Decel Time 2</b> These values correspond to the time required for the output frequency to decelerate from the set maximum frequency (P1.2) to the zero frequency. These parameters provide the possibility to set two different acceleration/deceleration time sets for one application. The active set can be selected with the programmable digital input.	1, 2, 3, 4	RW
256	P7.15	<b>Skip F1 Low Limit</b> In some systems, it may be necessary to avoid certain frequencies because of mechanical resonance problems. With these parameters, limits are set for the “skip frequency” regions. The frequency converter will skip the set frequency, ramp time will be the same.	1, 2, 3, 4	RW
257	P7.16	<b>Skip F1 High Limit</b> In some systems, it may be necessary to avoid certain frequencies because of mechanical resonance problems. With these parameters, limits are set for the “skip frequency” regions. The frequency converter will skip the set frequency, ramp time will be the same.	1, 2, 3, 4	RW
258	P7.17	<b>Skip F2 Low Limit</b> In some systems, it may be necessary to avoid certain frequencies because of mechanical resonance problems. With these parameters, limits are set for the “skip frequency” regions. The frequency converter will skip the set frequency, ramp time will be the same.	1, 2, 3, 4	RW
259	P7.18	<b>Skip F2 High Limit</b> In some systems, it may be necessary to avoid certain frequencies because of mechanical resonance problems. With these parameters, limits are set for the “skip frequency” regions. The frequency converter will skip the set frequency, ramp time will be the same.	1, 2, 3, 4	RW
260	P7.19	<b>Skip F3 Low Limit</b> In some systems, it may be necessary to avoid certain frequencies because of mechanical resonance problems. With these parameters, limits are set for the “skip frequency” regions. The frequency converter will skip the set frequency, ramp time will be the same.	1, 2, 3, 4	RW
261	P7.20	<b>Skip F3 High Limit</b> In some systems, it may be necessary to avoid certain frequencies because of mechanical resonance problems. With these parameters, limits are set for the “skip frequency” regions. The frequency converter will skip the set frequency, ramp time will be the same.	1, 2, 3, 4	RW

**Figure 79. Example of skip frequency area setting.**

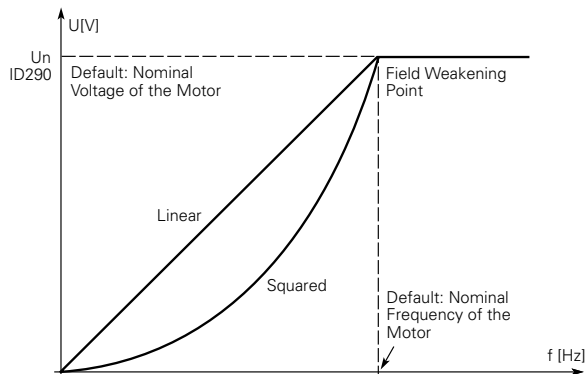


Modbus ID	Code	Parameters	Application	RO/RW
264	P7.21	<p><b>Skip Range Ramp Factor</b></p> <p>Defines the acceleration/deceleration time when the output frequency is between the selected prohibit frequency range limits. The ramping speed (selected acceleration/deceleration time 1 or 2) is multiplied with this factor. e.g., value 0.1 makes the acceleration time 10 times shorter than outside the prohibit frequency range limits.</p> <p><b>Figure 80. Ramp speed scaling between skip frequencies.</b></p>	1, 2, 3, 4	RW
267	P7.22	<p><b>Power Loss Function</b></p> <p>This enables the drive to reduce output voltage to the motor to keep the drive powered up as long as it can before power is lost. The motor is used as a generator to feed the DC bus. This mode is engaged at the following levels - 230 V - 156.8 Vdc, 480 V - 303 Vdc, and 575 - 426.65 Vdc.</p> <p>1 = Enable power loss function 0 = Disable power loss function</p>	1, 2, 3, 4	RW
268	P7.23	<p><b>Power Loss Time</b></p> <p>Allowable power loss max time before the drive shuts down. If AC input voltage recovers before this time setting, drive shall continue to operate.</p>	1, 2, 3, 4	RW
2122	P7.24	<p><b>Currency</b></p> <p>Sets the local currency used for energy savings estimation.</p>	1, 2, 3, 4	RW
2123	P7.25	<p><b>Energy Cost</b></p> <p>Sets the local energy cost per kW, used for energy savings estimation.</p>	1, 2, 3, 4	RW
2124	P7.26	<p><b>Data Type</b></p> <p>Selects the format to view energy savings. The drive takes four recordings in an hour and then calculates the average based off this parameter. The savings estimation is based on comparing the drives energy usage compared to a across the line starter.</p>	1, 2, 3, 4	RW
2125	P7.27	<p><b>Energy Savings Reset</b></p> <p>Resets the energy savings value.</p>	1, 2, 3, 4	RW
2444	P7.28	<p><b>2nd Stage Ramp Frequency</b></p> <p>When 2nd Stage Ramp Frequency is the frequency level at which the drive will enable the 2nd Stage Ramp Frequency output function. This then can be used for other inputs or devices to signal a frequency level.</p>	1, 2, 3, 4	RW
2515	P7.29	<p><b>Change Phase Sequence Motor</b></p> <p>This parameter allows for swapping the motor phase output from u, v, w to u, w, v.</p>	1, 2, 3, 4	RW
2667	P7.30	<p><b>Run Remove Stop Mode</b></p> <p>Drive will use this stop mode setting if run enable signal removed.</p> <p>Default value should be coast stop.</p>	1, 2, 3, 4	RW

## Appendix A—Description of parameters

Modbus ID	Code	Parameters	Application	RO/RW
287	P8.1	<b>Motor Control Mode</b> 0 = Frequency control - Output frequency is controlled directly by the frequency reference. 1 = Speed control - Output frequency is controlled by giving a frequency reference to it with slip compensation. 2 = Open loop vector control - Similar to the standard speed control mode, higher performance slip calculation requires running a motor Identification. 3 = PM Control1 - PM motor control mode 1, used for SPM (surface mounted permanent magnet) and it also can be used for IPM. 4 = PM Control2 - PM motor control mode 2, used for IPM (internally mounted permanent magnet) and it can not be used for SPM.	1, 2, 3, 4	RW
107	P8.2	<b>Current Limit</b> This parameter determines the maximum output current allowed from the drive. Once the motor current hits this level, it goes into the current limiter controller and tries to limit the output current.	1, 2, 3, 4	RW
109	P8.3	<b>V/Hz Optimization</b> Automatic torque boost. The voltage to the motor increases automatically, which assists the motor to produce sufficient torque to start and run at low frequencies with high loads. To obtain the required torque, the zero point voltage and midpoint voltage/frequency (in parameter group P8) need to be set, so that the motor can draw enough current at the low frequencies. First set parameter P8.4 to Programmable V/Hz curve (value 2). Increase the zero point voltage P8.9 to get enough current at zero speed. Then set the midpoint voltage P8.8 to 100% and the midpoint frequency P8.7 to value $P8.8/100\% * P1.9$ . <b>Note:</b> In high torque - low speed applications - it is likely that the motor will overheat. If the motor has to run a prolonged time under these conditions, special attention must be paid to cooling the motor. Use external cooling for the motor if the temperature tends to rise too high. 0 = Disable torque boost function. 1 = Enable torque boost function.	1, 2, 3, 4	RW
108	P8.4	<b>V/Hz Ratio</b> 0 = Linear - The voltage of the motor changes linearly with the frequency in the constant flux area from 0 Hz to the field weakening point where the nominal voltage is supplied. A linear V/Hz ratio should be used in constant torque applications. 1 = Squared - The voltage of the motor changes following a squared curve with the frequency in the area from 0 Hz to the field weakening point where the nominal voltage is supplied. The motor runs under magnetized below the field weakening point and produces less torque and electromechanical noise. A squared V/Hz ratio can be used in applications where the torque demand of the load is proportional to the square of the speed.	1, 2, 3, 4	RW

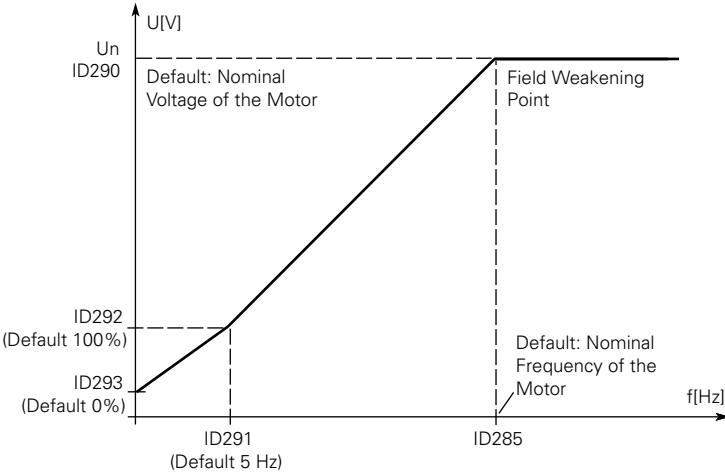
**Figure 81. Linear and squared change of motor voltage.**



Modbus ID	Code	Parameters	Application	RO/RW
108	P8.4	V/Hz Ratio, continued	1, 2, 3, 4	RW

2 = Programmable V/Hz curve - The V/Hz curve can be programmed with three different points. These points are the 0 frequency voltage, midpoint, and weakening point. A programmable V/Hz curve can be used if the other settings do not satisfy the needs of the application. When running the motor identification, this parameter gets set by default along with the values below for the V/Hz curve along with the resistance information of the motor.

Figure 82. Programmable V/Hz curve.



**Manual Motor Tuning - in Multi-purpose App**

- Setting the motor magnetizing current:
  - Run the motor at 2/3 of the motor nominal frequency as the frequency reference.
  - Read the motor current in the Monitor menu or via the InControl PC tool.
  - Set the current as the motor excitation current (P8.54)
- Set the V/Hz optimization parameter (P8.4) to value 2 "Programmable V/Hz curve".
- Run the motor with zero frequency reference and increase the motor zero point voltage (P8.9) until the motor current is approximately same as the motor excitation current. If the Motor is in a low frequency area for only short periods, 65% of the motor nominal current is possible.
- Set the midpoint voltage (P8.8) to  $1.4142 \cdot (P8.9)$  and midpoint frequency (P8.7) to value  $P8.7/100\% \cdot P1.9$ .
- If required, activate the speed control or V/Hz optimization (torque boost).
- If required, activate the speed control and V/Hz optimization (torque boost).

**Linear with flux optimization**

3 = The drive starts to search for the minimum motor current in order to save energy. This mode is called Active Energy Control which will reduce the voltage and current but still maintain the desired speed.

289	P8.5	<b>Field Weakening Point</b> The field weakening point is the frequency at which the output voltage reaches the set maximum value. This value is usually determined by the motor nameplate value. This function can be used in applications with constant motor load, such as fans, pumps, etc.	1, 2, 3, 4	RW
290	P8.6	<b>Voltage at FWP</b> Defines the voltage at the field weakening point. When the output frequency exceeds the field weakening point the voltage will remain constant. Below the frequency at the field weakening point, the output voltage depends on the setting of the V/Hz curve parameters (see P8.3, P8.4, P8.6, and P8.8). When the parameters P1.8 and P1.9 (nominal voltage and nominal frequency of the motor) are set, the parameters P8.5 and P8.6 are automatically set to the corresponding values (FWP nominal frequency, voltage 100% = nominal voltage). If you need different values for the field weakening point and the maximum output voltage, change these parameters after setting P1.8 and P1.9.	1, 2, 3, 4	RW

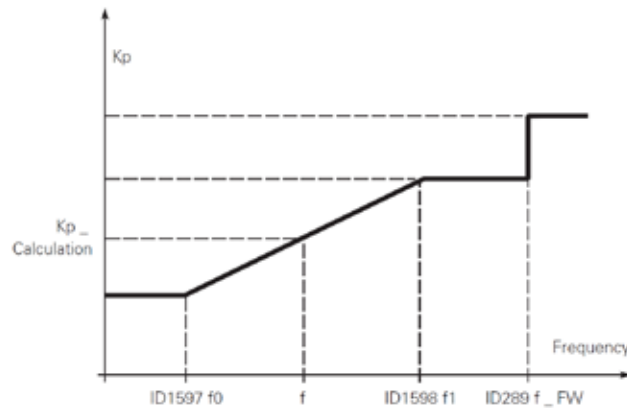
## Appendix A—Description of parameters

Modbus ID	Code	Parameters	Application	RO/RW
291	P8.7	<p><b>V/Hz Mid Frequency</b></p> <p>If the programmable V/Hz curve has been selected with the P8.4, this parameter defines the midpoint frequency of the curve. This value can be set anywhere between 0 and the field weakening point (P8.5). To either have a different V/Hz ramp or if set to the FWP, it will provide the field weakening point voltage all the way up the curve.</p>	1, 2, 3, 4	RW
292	P8.8	<p><b>V/Hz Mid Voltage</b></p> <p>If the programmable V/Hz curve has been selected with the P8.4, this parameter defines the midpoint voltage of the curve. This value can be set anywhere between zero frequency volt and the field weakening point voltage (P8.6).</p>	1, 2, 3, 4	RW
293	P8.9	<p><b>Zero Frequency Voltage</b></p> <p>If the programmable V/Hz curve has been selected with the P8.4, this parameter defines the zero frequency voltage of the curve. When putting this value above 0%, additional voltage is given. In some cases, by putting this value too high, it can cause the motor to be oversaturated.</p>	1, 2, 3, 4	RW
2522	P8.10	<p><b>Switching Frequency</b></p> <p>This parameter sets the frequency on which the PWM wave rides. Higher switching frequency will be cleaner current sine wave, lower switching frequency will be a choppier current sine wave. Motor noise can be minimized using a high switching frequency, but the amount of heat dissipation increases. Increasing the switching frequency reduces the capacity of the frequency converter unit. For protection against thermal overload, the switching frequency automatically is reduce in the fact that the ambient temperature is high as well as high load currents.</p> <p><b>Note:</b> See Installation Manual (MN040002EN) for the values listed for the individual frame size switching frequency ranges. It also provides de-rating tables required for sizing.</p>	1, 2, 3, 4	RW
1665	P8.11	<p><b>Sine Filter Enable</b></p> <p>This parameter enables the drive to have a fixed switching frequency which is required by some sine filters. The drive no longer automatically adjusts the switching frequency based on the unit temperature.</p>	1, 2, 3, 4	RW
294	P8.12	<p><b>OverVoltage Control</b></p> <p>The overvoltage control is used to limit the DC link voltage below the preset limit value. If over voltage control is enabled, the drive will control the DC link voltage below the preset limit value by increasing the output frequency to allow the motor to use the energy.</p> <p>0 = Disable over voltage controller.            1 = The max. controller output frequency is the (ramp frequency +8 Hz).            2 = The max. controller output frequency is the max. frequency.            3 = The max. controller output frequency is the (max frequency + 8 Hz).</p>	1, 2, 3, 4	RW
298	P8.13	<p><b>Load Drooping</b></p> <p>The drooping function enables speed drop as a function of load. This parameter sets that amount corresponding to the nominal torque of the motor. This is typically used in sharing of loads with multiple VFD's.</p>	4	RW
299	P8.14	<p><b>Identification</b></p> <p>This parameter enables the drive to make a motor identification cycle of the motor. Once complete, the drive will adjust tuning parameters to improve starting torque and open loop vector control performance. Once set and a run command is given, the operation will be active then set back to 0 when completed. When a run command is issued, the message on the keypad will indicate "Auto tuning" is being performed. If there is an issue with the motor identification, a fault message will be displayed.</p> <p>0 = Not action.            1 = Identification only stator resistor - Does not spin the motor can be done with load attached.            2 = Identification with run - Motor stator resistor is completed then the motor is run, must be completed with unloaded motor.            3 = Identification no run - Motor is supplied with current and voltage but at zero frequency.            4 = Identification only inertia - Identification for the system inertia only when load can not be decoupled.</p>	4	RW
1574	P8.15	<p><b>Neg Frequency Limit</b></p> <p>Frequency limit in the reverse direction in Open Loop Control mode.</p>	4	RW
1576	P8.16	<p><b>Pos Frequency Limit</b></p> <p>Frequency limit in the forward direction in Open Loop Control mode.</p>	4	RW



Modbus ID	Code	Parameters	Application	RO/RW
1585	P8.17	<b>Frequency Ramp Out Filter Time Constant</b> Filter time used when ramping the drive to its stop mode.	1, 2, 3, 4	RW
1591	P8.18	<b>Speed Error Filter Time Constant</b> Filter time constant for speed reference and actual speed error.	4	RW
1593	P8.20	<b>Speed Control Kp0</b> This parameter is the gain for the speed controller in open loop control mode given in % per Hz. Gain value of 100% means that the nominal torque reference is produced at the speed controller output for a frequency error of 1 Hz (see Figure 83 in P8.25).	4	RW
1594	P8.21	<b>Speed Control Ti0</b> Sets the integral time constant for the speed controller.	4	RW
1597	P8.24	<b>Speed Control F0</b> Speed level in Hz below the speed controller gain is equal to the speed control gain below F0 (see Figure 83 in P8.25).	4	RW
1598	P8.25	<b>Speed Control F1</b> The speed level in Hz above the speed controller gain is equal to the speed control gain (P8.20). From the speed defined by the F0 (P8.24) setting to the speed defined by the F1 (P8.25) setting, the speed controller gain changes linearly from the F0 gain to the speed gain Kp (see image below).	4	RW

**Figure 83. Speed control F1.**



1599	P8.26	<b>Speed Control Kp1</b> The relative gain of the speed controller as a percentage of the speed control gain (P8.20). When torque reference or speed control output is less than the value of speed control Ti0 (P8.27) . This parameter is normally used to stabilise the speed controller for a drive system with gear backlash.	4	RW
1600	P8.27	<b>Speed Control Ti1</b> Sets the integral time constant for the speed controller.	4	RW
1602	P8.29	<b>Motoring Torque Limit</b> Torque limit setting in the motoring side.	4	RW
1603	P8.30	<b>Generator Torque Limit</b> Torque limit setting for the generating side.	4	RW
1604	P8.31	<b>Torque Limit Forward</b> Torque limit setting in forward direction.	4	RW
1605	P8.32	<b>Torque Limit Reverse</b> Torque limit setting in reverse direction.	4	RW
1607	P8.33	<b>Motoring Power Limit</b> Motor power limit setting.	4	RW
1608	P8.34	<b>Generator Power Limit</b> Generator power limit setting.	4	RW
1611	P8.35	<b>Acc Compensation Time Constant</b> This value will compensate for the amount of inertia on the motor when starting and stopping. It improves speed response and is defined as acceleration time to nominal speed with nominal torque.	4	RW

## Appendix A—Description of parameters

Modbus ID	Code	Parameters	Application	RO/RW
1612	P8.36	<b>Acc Compensation Filter Time Constant</b> The filter time for the acceleration compensation time constant (P8.35). Used to remove any disturbances in the inertia feedback.	4	RW
1620	P8.37	<b>Flux Reference</b> This parameter defines the amount of flux that is output to the motor, which is valid only in open loop vector control.	4	RW
1630	P8.43	<b>Droop Control Filter Time Constant</b> Filter time when using droop control.	4	RW
1631	P8.44	<b>Startup Torque Selection</b> Voltage across the q-axis stator inductance of the PM motor at the rated motor current and the rated motor frequency displayed in line-to-line rms value. Value is measured when performing Identification.	4	RW
1632	P8.45	<b>Torque Memory Start</b> This starting torque reference comes from the actual torque (P8.48). On start, it will use the measured actual torque value stored to memory and then use that value the next time a start is required.	4	RW
1633	P8.46	<b>Startup Torque Forward</b> Defines the amount of starting torque reference applied on startup in the forward direction when selected in P8.44.	4	RW
1634	P8.47	<b>Startup Torque Reverse</b> Defines the amount of starting torque reference applied on startup in the reverse direction when selected in P8.44.	4	RW
1635	P8.48	<b>Startup Torque Actual</b> Actual starting torque	4	RO
1667	P8.49	<b>Startup Torque Time</b> This time is used to define the amount of time the start torque value assigned in P8.44 will be applied for before the normal torque reference is used.	4	RW
771	P8.50	<b>Stator Resistor</b> Motor stator resistor real value. This value is the stator winding resistance of the windings in the motor. Value is measured when performing Identification (P8.14).	4	RW
772	P8.51	<b>Rotor Resistor</b> Motor rotor resistor real value. This value is the rotor resistance of the motor. Value is measured when performing Identification (P8.14).	4	RW
773	P8.52	<b>Leak Inductance</b> Motor leakage inductance real value. This value is the amount of magnetic inductance that does not link to a winding in the motor. Value is measured when performing Identification (P8.14).	4	RW
774	P8.53	<b>Mutual Inductance</b> Motor mutual inductance real value. This value is the amount of inductance between 2 sets of windings in the motor. Value is measured when performing Identification (P8.14).	4	RW
775	P8.54	<b>Excitation Current</b> Motor no-load current real value. This value is the amount of electrical current required to generate a rotating magnetic field in the motor. Value is measured when performing Identification (P8.14).	4	RW
1656	P8.59	<b>VF Stable Kd</b> The compensation coefficient of the d-axis, which is used to suppress oscillation.	1, 2, 3, 4	RW
1657	P8.60	<b>VF Stable Kq</b> The compensation coefficient of the q-axis, which is used to suppress oscillation.	1, 2, 3, 4	RW
2835	P8.61	<b>Over Modulation Enable</b> Voltage drop of rectifier circuit may impact the required maximum motor output voltage. Enabling the over modulation allows for compensating the rectifier drop and helps increase the output voltage ( roughly 0~10% ). The side effect of over modulation results in increase in harmonic, impacting the stability, so it should be used per application requirement. Over modulation control is only available for V/Hz control.	1, 2, 3, 4	RW
2837	P8.62	<b>Motor Inertia</b> System rotation inertia real value for speed loop parameter tuning. Value is measured when performing Identification.	4	RW
1882	P8.63	<b>PM BEMF Voltage</b> Back electromotive force (EMF) voltage. Value is measured when performing Identification.	4	RW

Modbus ID	Code	Parameters	Application	RO/RW
1883	P8.64	<b>PM Q-axis Stator Inductance</b> Voltage across the q-axis stator inductance of the PM motor at the rated motor current and the rated motor frequency displayed in line-to-line rms value. Value is measured when performing identification.	4	RW
1884	P8.65	<b>PM D-axis Stator Inductance</b> Voltage across the d-axis stator inductance of the PM motor at the rated motor current and the rated motor frequency displayed in line-to-line rms value. Value is measured when performing identification.	4	RW
1890	P8.66	<b>PM Initial Selection</b> PM initial angle detect method.	4	RW
1891	P8.67	<b>PM Initial Time</b> PM initial angle detect time.	4	RW
1892	P8.68	<b>PM Excited Current</b> PM excited current during the low speed.	4	RW
1893	P8.69	<b>PM Excited Current Off frequency</b> PM excited current cut off frequency.	4	RW
2901	P8.70	<b>Observer Kp</b> Linear gain of the PM/IM observer.	4	RW
1664	P8.71	<b>Slip Compensation Coefficient</b> The linear coefficient of the slip compensation frequency, which is valid only in the speed control mode.	1, 2, 3, 4	RW
306	P9.1	<b>4 mA Input Fault</b> A warning or a fault action and message is generated if the 4–20 mA reference signal is used and the signal falls below 4 mA for 5 seconds or below 0.5 mA for 0.5 seconds. The information can also be programmed into digital output DO1 or relay outputs RO1 and RO2. 0 = No response. 1 = Warning. 2 = Warning, the frequency from 10 seconds back is set as reference. 3 = Warning, the preset frequency P9.2 is set as reference. 4 = Fault, stop mode after fault according to parameter stop mode (P7.10). 5 = Fault, stop mode after fault always by coasting.	1, 2, 3, 4	RW
331	P9.2	<b>4 mA Fault Frequency</b> When 4 mA fault happens, the output frequency of drive goes to this preset speed when P9.1 = 3.	1, 2, 3, 4	RW
307	P9.3	<b>External Fault</b> A warning or a fault action and message is generated from the external fault signal in the programmable (digital inputs function select external fault DIN3 is defaulted). The status information can also be programmed into digital output relay outputs RO1 and RO2. 0 = No response. 1 = Warning. 2 = Fault, stop mode after fault according to parameter stop mode (P7.10). 3 = Fault, stop mode after fault always by coasting.	1, 2, 3, 4	RW
332	P9.4	<b>Input Phase Fault</b> The input phase supervision ensures that the input phases of the frequency converter have approximately equal current draw. See Par ID 307.	1, 2, 3, 4	RW
330	P9.5	<b>Uvolt Fault Response</b> Frequency converter monitors DC bus voltage. If it drops below set level (via trouble shooting guide for more information on fault level) the drive will respond corresponding to this setting. See Par ID 307.	1, 2, 3, 4	RW
308	P9.6	<b>Output Phase Fault</b> Output phase supervision of the motor ensures that the motor phases have equal currents. If phases are 5% difference from one another, the frequency converter will respond corresponding to this setting. See Par ID 307.	1, 2, 3, 4	RW

## Appendix A—Description of parameters

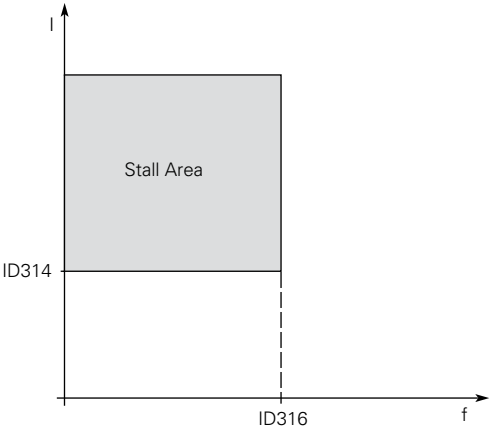
Modbus ID	Code	Parameters	Application	RO/RW
309	P9.7	<p><b>Ground Fault</b></p> <p>Earth fault protection ensures that the sum of the motor phase currents is zero. There is a current level setting parameter ground fault limit that allows for setting the allowable ground current level based off the total drive current. The over-current protection is always working and protects the frequency converter from earth faults with high currents. Frequency converter will correspond to the the setting below.</p> <p>See Par ID 307.</p>	1, 2, 3, 4	RW
310	P9.8	<p><b>Motor Thermal Protection</b></p> <p>If a fault condition is selected, the drive will stop and activate the fault stage based off the % of calculated motor temperature. The calculated motor temp. is based off the install power on values of the drive and monitoring values as the drive is running. Deactivating this protection, (i.e., setting parameter to 0) will reset the thermal stage of the motor to 0%.</p> <p>See Par ID 307.</p>	1, 2, 3, 4	RW
311	P9.9	<p><b>Motor Thermal F0 Current</b></p> <p>The current can be set between 0–150.0% x InMotor. This parameter sets the value for thermal current at zero frequency.</p> <p>The default value is set assuming that there is no external fan cooling the motor. If an external fan is used, this parameter can be set to 90% (or even higher).</p> <p><b>Note:</b> The value is set as a percentage of the motor nameplate data, parameter “nominal current of the motor” (P1.5), not the drive’s nominal output current. The motor’s nominal current is the current that the motor can withstand in direct on-line use without being overheated.</p> <p>If you change the parameter nominal current of motor, this parameter is automatically restored to the default value.</p> <p>Setting this parameter does not affect the maximum output current of the drive which is determined by P1.16 alone.</p> <p><b>Figure 84. Motor thermal current it curve.</b></p>	1, 2, 3, 4	RW
313	P9.11	<p><b>Stall Protection</b></p> <p>Stall protection is a user defined of over-current protection. It protects the motor from short time overload situations like a stalled shaft. This is customer selectable based off of current level, frequency level and time.</p> <p>0 = No action.  1 = Warning.  2 = Fault.  3 = Fault, coast.</p>	1, 2, 3, 4	RW

Modbus ID	Code	Parameters	Application	RO/RW
314	P9.12	<b>Stall Current Limit</b>	1, 2, 3, 4	RW

The current can be set to  $0.1 \text{--} I_{nMotor} \times 2$ . For a stall stage to occur, the current must have exceeded this limit.

The software does not allow entering a greater value than  $I_{nMotor} \times 2$ . If parameter "nominal motor current" (P1.5) is changed, this parameter is automatically restored to the default value (IL).

**Figure 85. Stall characteristics settings.**

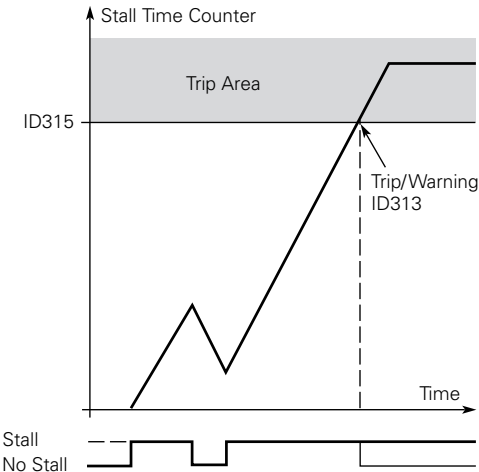


315	P9.13	<b>Stall Time Limit</b>	1, 2, 3, 4	RW
-----	-------	-------------------------	------------	----

This time can be set between 1.0 and 120.0 s.

This is the maximum time allowed for a stall stage. The stall time is counted by an internal up/down counter based off the current being above the limit setting. If the stall time counter value goes above this limit the stall protection will cause a trip according to protection parameter P9.11.

**Figure 86. Stall time count.**



316	P9.14	<b>Stall Frequency Limit</b>	1, 2, 3, 4	RW
-----	-------	------------------------------	------------	----

The frequency can be set between  $1 \text{--} f_{max}$  (P1.1.2).

For a stall state to occur, the output frequency must have remained below this limit, above the current limit for the stall time to occur.

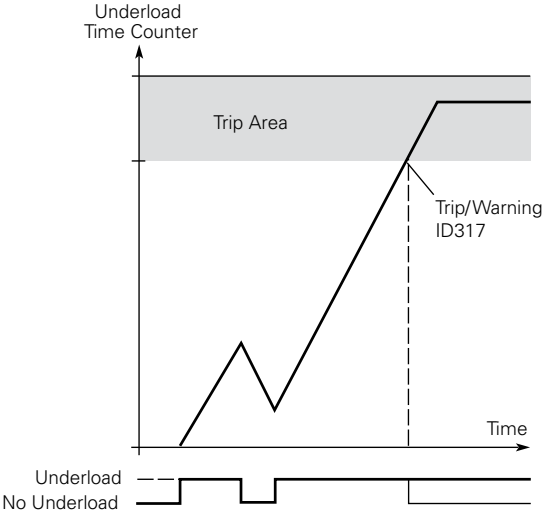
## Appendix A—Description of parameters

Modbus ID	Code	Parameters	Application	RO/RW
317	P9.15	<p><b>Underload Protection</b></p> <p>If fault is set as the function. The drive will stop and activate the fault stage based on the parameter conditions and the monitoring status of the motor. If the motor torque drops below the <math>F_{nom}</math> and <math>F_0</math> torque levels for the time limit, the protection is enabled. Deactivating the protection by setting the parameter to 0 will reset the underload time counter to zero.</p> <p>0 = No response.            1 = Warning.            2 = Fault, stop mode after fault according to parameter stop mode (P7.10).            3 = Fault, stop mode after fault always by coasting.</p>	1, 2, 3, 4	RW
318	P9.16	<p><b>Underload From Torque</b></p> <p>The torque limit can be set between 10.0–150.0 % x <math>T_{nMotor}</math>.</p> <p>This parameter gives the value for the minimum torque allowed when the output frequency is at or above the field weakening point.</p> <p>If you change parameter “nominal motor current” (P1.5), this parameter is automatically restored to the default value.</p> <p><b>Figure 87. Setting of minimum load.</b></p>	1, 2, 3, 4	RW
319	P9.17	<p><b>Underload F0 Torque</b></p> <p>The torque limit can be set between 5.0–150.0 % x <math>T_{nMotor}</math>.</p> <p>This parameter gives the value for the minimum torque allowed at zero frequency.</p> <p>If you change the value of “nominal motor current” (P1.5), this parameter is automatically restored to the default value.</p>	1, 2, 3, 4	RW

Modbus ID	Code	Parameters	Application	RO/RW
320	P9.18	<b>Underload Time Limit</b>	1, 2, 3, 4	RW

This time can be set between 2.0 and 600.0 s.  
 This is the time allowed for an underload fault state to exist. An internal up/down counter counts the accumulated underload time. If the underload counter value goes above this limit, the protection will cause a trip according to protection parameter (P9.15). If the drive is stopped, the counter is reset to zero.

**Figure 88. Underload time counter function.**



333	P9.19	<b>Thermistor Fault Response</b>	1, 2, 3, 4	RW
<p>Setting the parameter to 0 will deactivate the protection. If motor thermistors input is enabled, it requires enabling the fault condition. The thermistor is usually in the winding of the motor or an external sensor. Motor thermal protection (P9.8) can be deactivated.</p> <p>0 = No response.                      1 = Warning.                      2 = Fault, stop mode after fault according to parameter stop mode.                      3 = Fault, stop mode after fault always by coasting.</p>				

750	P9.20	<b>Line Start Lockout</b>	1, 2, 3, 4	RW
<p>Determines the response of frequency converter going to a run state cycle with I/O run command is still active as the control place.</p> <p>0 = Respond to I/O run command when power is applied. If in another control place and switched to I/O control, do not respond. (Run command has to be cycled.)                      1 = Do not respond to I/O run command when power is applied. If in another control place and switched to I/O control, do not respond. (Run command has to be cycled.)                      2 = Respond to I/O commands when power is applied. If in another control place and switched to I/O control, the drive will respond to a maintained run command.                      3 = Do not respond to I/O commands when power is applied. If in another control place and switched to I/O control, the drive will respond to a maintained run command.</p>				

## Appendix A—Description of parameters

Modbus ID	Code	Parameters	Application	RO/RW
334	P9.21	<p><b>Fieldbus Fault Response</b></p> <p>This sets the response mode for the Fieldbus fault when a Fieldbus mode is used and communication is lost between the PLC and communication port.</p> <p>Each protocol has another parameter to select in all control or only in Fieldbus control to set fault or warning.</p> <p>0 = No action            1 = Warning            2 = Fault            3 = Fault, Coast            4 = Warning, Coast            5 = Warning, Auto switch to local            6 = Warning, Auto switch to preset speed 1.</p>	1, 2, 3, 4	RW
335	P9.22	<p><b>OPTCard Fault Response</b></p> <p>This sets the response mode for a board slot fault caused by a missing or failed option board not communicating to the central processor.</p> <p>0 = No response            1 = Warning            2 = Fault, stop mode after fault according to parameter stop mode (P7.10)            3 = Fault, stop mode after fault always by coasting.</p>	1, 2, 3, 4	RW
1564	P9.23	<p><b>Unit Under Temp Prot</b></p> <p>This protection sets the response to a low frequency converter temperature on the heat sink.</p> <p>0 = No response            1 = Warning            2 = Fault, stop mode after fault according to parameter stop mode (P7.10)            3 = Fault, stop mode after fault always by coasting.</p>	1, 2, 3, 4	RW
321	P9.24	<p><b>AR Wait Time</b></p> <p>Defines the time before the frequency converter tries to automatically restart the motor after a specific fault condition has been clear. Auto restart faults listed below P9.27 to P9.33.</p>	1, 2, 3, 4	RW
322	P9.25	<p><b>AR Trail Time</b></p> <p>Amount of time after fault set that the drive uses the restart attempts to reset the fault and restart the motor. After this time has run out without resetting the alarm, drive will fault (see Figure 90 to show how auto restart functions).</p> <p>Attempts parameter (P9.27 to P9.33) to determine the maximum number of automatic restarts during the trial time set by P9.25. The time count starts from the first auto-restart. If the number of faults occurring during the trial time exceeds the attempts values of P9.27 to P9.33, the fault state becomes active. Otherwise the fault is cleared after the trial time has elapsed and the next fault starts the trial time count again.</p> <p>If a single fault remains during the trial time, a fault state is true.</p> <p><b>Figure 89. Auto restart fail (try number &gt;2).</b></p>	1, 2, 3, 4	RW



Modbus ID	Code	Parameters	Application	RO/RW
323	P9.26	<p><b>AR Start Function</b></p> <p>The start function for automatic restart is selected with this parameter. The parameter defines the start mode upon a auto-restart condition:</p> <p>0 = Flying start from stop frequency.</p> <p>1 = Start according to parameter start mode (P7.9).</p> <p>2 = Flying start from max. frequency.</p>	1, 2, 3, 4	RW
324	P9.27	<p><b>Undervoltage Attempts</b></p> <p>This parameter determines how many automatic restarts can be made during the trial time set by P9.25 after an under-voltage trip.</p> <p>0 = No automatic restarts.</p> <p>&gt;0 = Number of automatic restarts after under-voltage fault. The fault is reset and the drive is started automatically after the DC-link voltage has returned to the normal level.</p>	1, 2, 3, 4	RW
325	P9.28	<p><b>OverVoltage Attempts</b></p> <p>This parameter determines how many automatic restarts can be made during the trial time set by P9.25 after an over-voltage trip.</p> <p>0 = No automatic restart after overvoltage fault trip.</p> <p>&gt;0 = Number of automatic restarts after overvoltage fault trip. The fault is reset and the drive is started automatically after the DC-link voltage has returned to the normal level.</p>	1, 2, 3, 4	RW
326	P9.29	<p><b>OverCurrent Attempts</b></p> <p>This parameter determines how many automatic restarts can be made during the trial time set by P9.25 after an overcurrent trip.</p> <p><b>Note:</b> An IGBT temperature fault, saturation fault, and over-current faults are included as part of this fault.</p> <p>0 = No automatic restart after over-current fault trip.</p> <p>&gt;0 = Number of automatic restarts after an over-current trip, saturation trip, or IGBT temperature fault.</p>	1, 2, 3, 4	RW
327	P9.30	<p><b>4 mA Fault Attempts</b></p> <p>This parameter determines how many automatic restarts can be made during the trial time set by P9.25 after 4 mA fault trip.</p> <p>0 = No automatic restart after reference fault trip.</p> <p>&gt;0 = Number of automatic restarts after the analog current signal (4–20 mA) has returned to the normal level (&gt;4 mA).</p>	1, 2, 3, 4	RW
329	P9.31	<p><b>Motor Temp Fault Attempts</b></p> <p>This parameter determines how many automatic restarts can be made during the trial time set by P9.25 after Motor temp fault trip.</p> <p>0 = No automatic restart after motor temperature fault trip.</p> <p>&gt;0 = Number of automatic restarts after the motor temperature has returned to its normal level.</p>	1, 2, 3, 4	RW
328	P9.32	<p><b>External Fault Attempts</b></p> <p>This parameter determines how many automatic restarts can be made during the trial time set by P9.25 after external fault trip.</p> <p>0 = No automatic restart after external fault trip.</p> <p>&gt;0 = Number of automatic restarts after external fault trip.</p>	1, 2, 3, 4	RW
336	P9.33	<p><b>Underload Attempts</b></p> <p>This parameter determines how many automatic restarts can be made during the trial time set by P9.25 after underload fault trip.</p> <p>0 = No automatic restart after an underload fault trip.</p> <p>&gt;0 = Number of automatic restarts after an underload fault trip.</p>	1, 2, 3, 4	RW
955	P9.34	<p><b>RTC Fault</b></p> <p>Real time clock (RTC) fault protection ensures the real time display is correct, and the interval and timer function can run normally.</p> <p>0 = No response.</p> <p>1 = Warning.</p> <p>2 = Fault, stop mode after fault according to stop mode (P7.10).</p> <p>3 = Fault, stop mode after fault always by coasting.</p>	1, 2, 3, 4	RW

## Appendix A—Description of parameters

Modbus ID	Code	Parameters	Application	RO/RW
337	P9.35	<p><b>PT100 Fault Response</b></p> <p>PT100 thermistor protection used with motor PT100 thermistors input option board are used to fault frequency converter if motor has reached the set temperature fault level on the option card. If using PT100 thermistors, motor thermal protection (P9.8) can be disabled.</p> <p>See Par ID 955.</p>	1, 2, 3, 4	RW
1256	P9.36	<p><b>Replace Battery Fault Response</b></p> <p>Sets how the frequency converter responds to a low voltage on the real time clock battery. If the voltage on the battery drops below 2 V, the drive will display a warning by default.</p> <p>See Par ID 955.</p>	1, 2, 3, 4	RW
1257	P9.37	<p><b>Replace Fan Fault Response</b></p> <p>Replace fan fault will show when the fan life is less than 2 months; remind user to replace the fan. The time is based off the power on time of the drive.</p> <p>See Par ID 955.</p>	1, 2, 3, 4	RW
1678	P9.38	<p><b>IP Address Confliction Resp</b></p> <p>Indicates there is a conflict in the IP address assigned to the drive, typically meaning there are multiple devices with the same IP address assigned.</p> <p>See Par ID 955.</p>	1, 2, 3, 4	RW
2126	P9.39	<p><b>Cold Weather Mode</b></p> <p>With this parameter, you are able to enable the cold weather function causing the frequency converter's under temp limit to drop from <math>-10^{\circ}\text{C}</math> to <math>-30^{\circ}\text{C}</math> drive. This then enables a warm-up feature when the frequency converter is between <math>-30^{\circ}\text{C}</math> and <math>-20^{\circ}\text{C}</math>. The motor, when given a run command, will turn on for the cold weather time-out (P9.41) and output the cold weather voltage (P9.40) at 0.5 Hz to allow the motor to warm up. If it does not warm up above <math>-20^{\circ}\text{C}</math>, after that the time frequency converter will fault on under temp fault. If the frequency converter does go above <math>-20^{\circ}\text{C}</math>, output will begin to follow reference.</p>	1, 2, 3, 4	RW
2127	P9.40	<p><b>Cold Weather Volt. Level</b></p> <p>With this parameter, you are able to select the % of the motor voltage that is output to the motor when in the cold weather warm-up period.</p>	1, 2, 3, 4	RW
2128	P9.41	<p><b>Cold Weather Time Out</b></p> <p>With this parameter, you are able to select the time limit that the frequency converter will run in the warmup period.</p>	1, 2, 3, 4	RW
2129	P9.42	<p><b>Cold Weather Password</b></p> <p>This password allows access to override the under temperature fault protection. This parameter is seen by pressing the left and right soft keys on the keypad. Password should be set to 62385, this value gets reset on cycle of power.</p>	1, 2, 3, 4	RW
2130	P9.43	<p><b>Under Temp Fault Override</b></p> <p>With the password set to the correct value this parameter is enabled and will give the ability to override the under temp fault. This function gets reset when power is cycled.</p>	1, 2, 3, 4	RW
2158	P9.44	<p><b>Ground Fault Limit</b></p> <p>Sets the level of the ground fault protection, this protection is based off the amount of leakage current that is seen to ground on the output of the drive.</p>	1, 2, 3, 4	RW
2157	P9.45	<p><b>Keypad Comm Fault Response</b></p> <p>This parameter defines the function of the keypad communication response in the case the keypad is removed.</p> <p>0 = No action. 1 = Warning. 2 = Fault. 3 = Fault, coast.</p>	1, 2, 3, 4	RW
2159	P9.46	<p><b>Preheat Mode</b></p> <p>This parameter enables/disables the preheat function where this is used in the case depending on where the temperature is being read from the drive. It will turn on the output to allow current to flow to the motor if the temperature of the drive drops. This is typically used when the motor is not running.</p> <p>0 = Disable. 1 = Enable.</p>	1, 2, 3, 4	RW

Modbus ID	Code	Parameters	Application	RO/RW
2160	P9.47	<b>Preheat Control Source</b> Selects the source of where the temperature is coming from, either digital input or the drive heat sink temperature, which potentially could be at a different temperature. 0 = DI function. 1 = Drive temperature.	1, 2, 3, 4	RW
2161	P9.48	<b>Preheat Enter Temp</b> Temperature when the preheat is enabled, drive goes into a run state to all the preheat voltage to flow through the motor and create some current.	1, 2, 3, 4	RW
2162	P9.49	<b>Preheat Quit Temp</b> Temperature when the preheat is disabled, drive goes into a stop state if the temperature is above this rating.	1, 2, 3, 4	RW
2163	P9.50	<b>Preheat Output Volt</b> Voltage level output to the motor when the drive is in the preheat operation mode. This is a percentage of the motor nameplate voltage.	1, 2, 3, 4	RW
2401	P9.51	<b>PID Feedback AI Loss Response</b> This parameter defines the function of the PID feedback analog Input loss response, if the AI feedback is lost based off the programmed AI feedback. 0 = No action. 1 = Warning 2 = Fault. 3 = Warning: preset frequency (P9.52). 4 = Warning: Analog -> Net.	2, 3, 4	RW
2402	P9.52	<b>PID Feedback AI Loss Pre Freq</b> This parameter defines the frequency the master would run to if a feedback is lost and PID feedback AI loss response (P9.51) was set to option 3.	2, 3, 4	RW
2403	P9.53	<b>PID Feedback AI Loss Pipe Fill Loss Level</b> Detects loss of prime in the pump based off the measured level. If the value drops below this level for the time-out time (P9.54) and below the frequency in pipe fill loss level (P9.53), "loss of prime" occurs.	2, 3, 4	RW
2404	P9.54	<b>PID Feedback AI Loss PreFreq Timeout</b> When response (P9.51) is set to 3 or 4, when the feedback signal is lost, the drive will run at the frequency set by AI loss Pre Freq (P9.52) for the time set here. After this time, the drive will fault out on "Feedback Loss". The time is disabled when set to 0 sec.	2, 3, 4	RW
2405	P9.55	<b>PID Feedback AI Loss Attempts</b> This parameter sets the amount of tries it will try to auto-restart the feedback AI loss fault.	2, 3, 4	RW
2427	P9.56	<b>STO Fault Response</b> STO Fault Response defines the function of how the STO input will be seen on the keypad and how the drive functions to it. 0 = No action - Drive will stop no indication shown, if STO clears drive will run without reset. 1 = Warning - Drive stop and indicate warning/if STO clears drive will run without reset. 2 = Fault - Drive will indicate fault/require reset to start again.	1, 2, 3, 4	RW
2483	P9.57	<b>Fault Reset Start</b> Defines how the drive functions after a fault reset is given if the run command has to be cycled or if still present it will start again. 0 = Follow run command - Follow Start/Stop input after fault reset. 1 = Rising edge after fault reset - Toggle of run input required to start after fault reset.	1, 2, 3, 4	RW
2657	P9.58	<b>Warning Operation Mode</b> Warning store and set rule. User could select save warning log in memory, or even do not pop out by keypad or PC tool.	1, 2, 3, 4	RW
2664	P9.59	<b>Fan Protection</b> Fan protection parameter.	1, 2, 3, 4	RW
2666	P9.60	<b>Under Voltage Trip Level</b> Under voltage trip level.	1, 2, 3, 4	RW
2803	P9.61	<b>OP Cont Interlock Attempts</b> OP cont. interlock attempts.	1, 2, 3, 4	RW

## Appendix A—Description of parameters

Modbus ID	Code	Parameters	Application	RO/RW
2831	P9.62	<b>OP Cont Interlock Protection</b> OP cont. interlock protection.	1, 2, 3, 4	RW
2895	P9.63	<b>CP Interlock Run Protection</b> CP interlock fault protection parameters only for drive running.	1, 2, 3, 4	RW
2896	P9.64	<b>CP Interlock Stop Protection</b> CP interlock fault protection parameters only for drive stop.	1, 2, 3, 4	RW
2897	P9.65	<b>CP Interlock Attempts</b> CP interlock fault running fault auto reset try number.	1, 2, 3, 4	RW
1294	P10.1	<b>PID1 Control Gain</b> Defines the gain of the PID Controller. It adjust the slope of the speed increase according to the initial of the load. If this value is set to 100% a change of 10% in the error value causes the controller output to change 10%.	2, 3, 4	RW
1295	P10.2	<b>PID1 Control ITime</b> Defines the integration time of the PID controller. Over the time the integral time contributes to the deviation between the reference and the feedback signal. If this value is set to 1.00 sec., a change of 10% in the error value causes the controller output to change by 10.00%/s. With value set to 0.0, frequency converter operates as PD controller.	2, 3, 4	RW
1296	P10.3	<b>PID1 Control DTime</b> Defines the derivation time of the PID controller. This value will adjust the rate of change on the feedback signal. If this value is set to 1.00 sec., a change of %10 in error value during 1.00 sec. causes the control output to change by %10.00. If value is set to 0.0, frequency converter operates as PI controller.	2, 3, 4	RW
1297	P10.4	<b>PID1 Process Unit</b> Defines the unit type for PID Feedback unit.	2, 3, 4	RW
1298	P10.5	<b>PID1 Process Unit Min</b> Defines the minimum process unit Value	2, 3, 4	RW
1300	P10.6	<b>PID1 Process Unit Max</b> Defines the maximum process unit Value	2, 3, 4	RW
1302	P10.7	<b>PID1 Process Unit Decimal</b> Defines the amount of decimal places in process unit Value	2, 3, 4	RW
1303	P10.8	<b>PID1 Error Inversion</b> Defines the way the process value output reacts to the feedback signal. 0 = Normal - If feedback is less than set-point, PID controller output increases. 1 = Inverted - If feedback is less than set-point, PID controller output decreases.	2, 3, 4	RW
1304	P10.9	<b>PID1 Dead Band</b> PID dead band around set-point in process units. This is the band where no actions occur, to prevent oscillation or repeated activation/deactivation of controller. The PID output is locked if the feedback stays within the dead band area.	2, 3, 4	RW
1306	P10.10	<b>PID1 Dead Band Delay</b> If the PID process value goes out of the dead band area for the desired time delay at that point the controller will re-initialize and try to level out again.	2, 3, 4	RW
1307	P10.11	<b>PID1 Keypad Set Point 1</b> Keypad PID reference value set point 1.	2, 3, 4	RW
1309	P10.12	<b>PID1 Keypad Set Point 2</b> Keypad PID reference value set point 2.	2, 3, 4	RW
1311	P10.13	<b>PID1 Ramp Time</b> Defines the rising and falling ramp times for changes in the process value.	2, 3, 4	RW
1312	P10.14	<b>PID1 Set Point 1 Source</b> Defines source of the set-point value the drive uses this can either be an internal preset value, keypad set-point, analog signal or Fieldbus message.	2, 3, 4	RW
1313	P10.15	<b>PID1 Set Point 1 Min</b> Defines minimum value for the set point 1 source.	2, 3, 4	RW
1314	P10.16	<b>PID1 Set Point 1 Max</b> Defines maximum value for the set point 1 source.	2, 3, 4	RW

Modbus ID	Code	Parameters	Application	RO/RW
1315	P10.17	<b>PID1 Sleep Enable When Using Set Point 1</b> Enable PID set-point sleep mode. This function will disable the output when the frequency drops below, or increase above, depends on application the sleep frequency for the sleep delay time. The output re-engages when feedback rises above the wakeup level.	2, 3, 4	RW
2396	P10.18	<b>PID1 Sleep Level Unit When Using Set Point 1</b> Defines what value would be looked at when drive is going into the sleep mode when the motor is not required to run. 0 = Output frequency. 1 = Motor speed. 2 = Motor current. 3 = PID1 feedback.	2, 3, 4	RW
2450	P10.19	<b>PID1 Sleep Level When Using Set Point 1</b> Defines the level of which the unit value is used to look at to go into the sleep mode. When the unit drops below, or increase above, depend on application this level for the sleep delay time it will put the drive into the sleep mode.	2, 3, 4	RW
1317	P10.20	<b>PID1 Sleep Delay When Using Set Point 1</b> This parameter sets the delay time after the set-point drops below the sleep level for this amount of time and then the drives output will shut off until the wakeup level is met. It is to prevent large fluctuations when going into the sleep function to save motor run time.	2, 3, 4	RW
1318	P10.21	<b>PID1 Wakeup Level When Using Set Point 1</b> Defines the level for the PID feedback value to go above top enable the PID output to be re enabled. This value is based of the % of feedback which can be scaled based off the PID Unit Min/Max values P10.5 and P10.6.	2, 3, 4	RW
1320	P10.22	<b>PID1 Set Point 1 Boost</b> The set-point can be boosted via a multiplier value.	2, 3, 4	RW
1321	P10.23	<b>PID1 Set Point 2 Source</b> Defines source of the set-point value the drive uses. This can either be an internal preset value, keypad set-point, analog signal, or Fieldbus message.	2, 3, 4	RW
1322	P10.24	<b>PID1 Set Point 2 Min</b> Defines minimum value for the set point 2 source.	2, 3, 4	RW
1323	P10.25	<b>PID1 Set Point 2 Max</b> Defines maximum value for the set point 2 source.	2, 3, 4	RW
1324	P10.26	<b>PID1 Sleep Enable When Using Set Point 2</b> Enable PID set-point sleep mode. This function will disable the output when the frequency drops below, or increase above, depend on application of the sleep frequency for the sleep delay time. The output re-engages when feedback rises above the wakeup level.	2, 3, 4	RW
2397	P10.27	<b>PID1 Sleep Level Unit When Using Set Point 2</b> Defines what value would be looked at when drive is going into the sleep mode when the motor is not required to run. 0 = Output frequency. 1 = Motor speed. 2 = Motor current. 3 = PID1 feedback.	2, 3, 4	RW
2452	P10.28	<b>PID1 Sleep Level When Using Set Point 2</b> Defines the level of which the unit value is used to look at to go into the sleep mode. When the unit drops below or increase above depend on application this level for the sleep delay time it will put the drive into the sleep mode.	2, 3, 4	RW
1326	P10.29	<b>PID1 Sleep Delay When Using Set Point 2</b> This parameter sets the delay time after the set-point drops below the sleep level for this amount of time and then the drives output will shut off till the wakeup level is met. It is to prevent large fluctuations when going into the sleep function to save motor run time.	2, 3, 4	RW
1327	P10.30	<b>PID1 Wakeup Level when Using Set Point 2</b> Defines the level for the PID feedback value to go above top enable the PID output to be re enabled. This value is based of the % of feedback which can be scaled based off the PID Unit Min/Max values P10.5 and P10.6.	2, 3, 4	RW
1329	P10.31	<b>PID1 Set Point 2 Boost</b> The set-point can be boosted via a multiplier value.	2, 3, 4	RW

## Appendix A—Description of parameters

Modbus ID	Code	Parameters	Application	RO/RW
1330	P10.32	<b>PID1 Feedback Function</b> Choose a single signal used as feedback, this parameter allows for doing math functions with 2 sources.	2, 3, 4	RW
1331	P10.33	<b>PID1 Feedback Gain</b> Define gain associated with feedback signal from the measuring device.	2, 3, 4	RW
1332	P10.34	<b>PID1 Feedback 1 Source</b> Define where feedback signal is being fed into the drive, via analog or Fieldbus data value.	2, 3, 4	RW
1333	P10.35	<b>PID1 Feedback 1 Min</b> Minimum unit value for the feedback signal.	2, 3, 4	RW
1334	P10.36	<b>PID1 Feedback 1 Max</b> Maximum unit value for the feedback signal.	2, 3, 4	RW
1335	P10.37	<b>PID1 Feedback 2 Source</b> Define where feedback signal is being fed into the drive, via analog, or Fieldbus data value.	2, 3, 4	RW
1336	P10.38	<b>PID1 Feedback 2 Min</b> Minimum unit value for the feedback signal.	2, 3, 4	RW
1337	P10.39	<b>PID1 Feedback 2 Max</b> Maximum unit value for the feedback signal.	2, 3, 4	RW
1338	P10.40	<b>PID1 Feedforward Func</b> Choose a single signal used as feed forward command. This is used to account for major disturbances that the processor does not see via the feedback.	2, 3, 4	RW
1339	P10.41	<b>PID1 Feedforward Gain</b> Define feed forward gain control level.	2, 3, 4	RW
1340	P10.42	<b>PID1 Feedforward 1 Source</b> Define where feed forward signal is fed from, this can either be an analog signal or Fieldbus process value.	2, 3, 4	RW
1341	P10.43	<b>PID1 Feedforward 1 Min</b> Define feed forward minimum value setting.	2, 3, 4	RW
1342	P10.44	<b>PID1 Feedforward 1 Max</b> Define feed forward maximum unit value setting.	2, 3, 4	RW
1343	P10.45	<b>PID1 Feedforward 2 Source</b> Define where feed forward signal is fed from, this can either be an analog signal or Fieldbus process value.	2, 3, 4	RW
1344	P10.46	<b>PID1 Feedforward 2 Min</b> Define feed forward minimum value setting.	2, 3, 4	RW
1345	P10.47	<b>PID1 Feedforward 2 Max</b> Define feed forward maximum unit value setting.	2, 3, 4	RW
1352	P10.48	<b>PID1 Set Point 1 Comp Enable</b> Enables pressure loss compensation for set-point 1 signal value.	2, 3, 4	RW
1353	P10.49	<b>PID1 Set Point 1 Comp Max</b> Value added proportionally to the frequency, set-point compensation = comp max * (output freq–min freq)/(max freq–min freq). Refer P10.51 for procedure for setting up PID application.	2, 3, 4	RW
1354	P10.50	<b>PID1 Set Point 2 Comp Enable</b> Enables pressure loss compensation for set-point 2 signal value.	2, 3, 4	RW
1355	P10.51	<b>PID1 Set Point 2 Comp Max</b>	2, 3, 4	RW

Modbus ID	Code	Parameters	Application	RO/RW
-----------	------	------------	-------------	-------

Value added proportionally to the frequency, set-point compensation =  $\text{comp max} * (\text{output freq} - \text{min freq}) / (\text{max freq} - \text{min freq})$ .

Procedure for setting up PID application.

Initially set PID gain (P10.1) to 0.0% and set the PID I time (P10.2) to 20 sec. Start the frequency converter and verify if the set-point is reached quickly while maintaining stable operation of the system. If not, increase the PID gain (P10.1) until the drive speed oscillates constantly. After this occurs, reduce the PID gain (P10.1) slightly to reduce the oscillation. From here, take the value found for PID gain (P10.1) to 0.5 times that value and reduce the PID I time (P10.2) until the feedback signal oscillates again. Increase the PID I time (P10.2) until the oscillation stops, with that value take it times 1.2 and use that value for the PID I time (P10.2). If signal noise is seen at high frequency, increase the filter time values to filter the signal. If further tuning is required, refer to the Figure 91 table showing what is effected.

**Figure 90. Setting up PID application.**

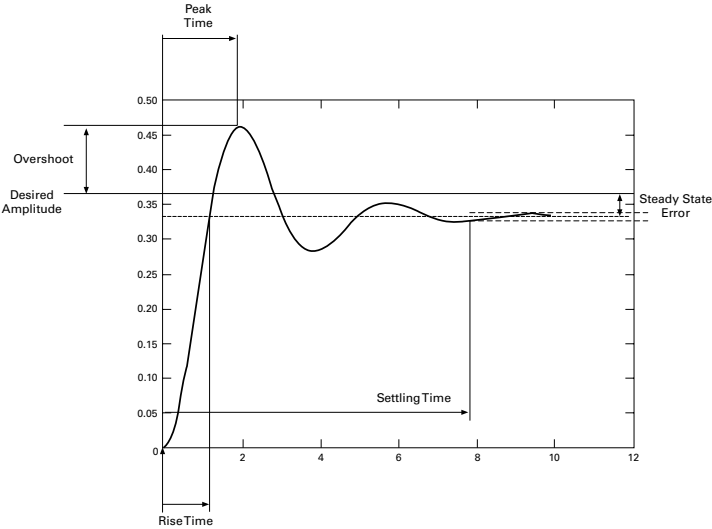
Response	Rise time	Overshoot	Settling time	Steady state error
Increase PID Gain	Decrease Rise	Increases Overshoot	Not Affected	Decreases Error
Increase PID1 Time	Decrease Rise	Increases Overshoot	Increases Setting	Eliminates Error
Increase PID0 Time	Not Affected	Decreases Overshoot	Decreases Setting	Not Affected

Rise Time - The time required for the output to rise 90% of the desired level for the first time.

Overshoot - The difference between the peak level and the steady state level.

Setting Time - Time required for the system to converge to its steady state.

Steady State Error - The difference between the steady state level and the desired output level.



2466	P10.52	<b>PID1 Wakeup Action</b> This parameter defines the wakeup function action. 0 = Wakeup when below wakeup level P10.21/P10.30. 1 = Wakeup when above wakeup level P10.21/P10.30. 2 = Wake up when below wakeup level % set in P10.21/P10.30 from PID set-point. 3 = Wakeup when above wakeup level %from PID set-point set in P10.21/P10.30.	2, 3, 4	RW
2542	P10.53	<b>FB PID1 Set Point 1</b> PID set-point 1 value from Fieldbus.	2, 3, 4	RW
2544	P10.54	<b>FB PID1 Set Point 2</b> PID set-point 2 value from Fieldbus.	2, 3, 4	RW
2550	P10.55	<b>FB PID1 Feedback 1</b> PID feedback 1 value from Fieldbus.	2, 3, 4	RW
2551	P10.56	<b>FB PID1 Feedback 2</b> PID reference value feedback 2 from Fieldbus.	2, 3, 4	RW

## Appendix A—Description of parameters

Modbus ID	Code	Parameters	Application	RO/RW
2554	P10.57	<b>FB PID1 Feedforward 1</b> PID reference value feed forward 1 from Fieldbus.	2, 3, 4	RW
2555	P10.58	<b>FB PID1 Feedforward 2</b> PID reference value feed forward 2 from Fieldbus.	2, 3, 4	RW
2660	P10.59	<b>PID1 Sleep Boost level</b> PID1 sleep boost level.	2, 3, 4	RW
2661	P10.60	<b>PID1 Sleep Boost Max Time</b> PID1 sleep boost max. time.	2, 3, 4	RW
2811	P10.61	<b>PID1 Low Feedback Level</b> PID1 low feedback level.	2, 3, 4	RW
2812	P10.62	<b>PID1 Low Feedback Time</b> PID1 low feedback time.	2, 3, 4	RW
2813	P10.63	<b>PID1 Low Feedback Protection</b> PID1 low feedback protection.	2, 3, 4	RW
2814	P10.64	<b>PID1 High Feedback Level</b> PID1 high feedback level.	2, 3, 4	RW
2815	P10.65	<b>PID1 High Feedback Time</b> PID1 high feedback time.	2, 3, 4	RW
2816	P10.66	<b>PID1 High Feedback Protection</b> PID1 high feedback protection.	2, 3, 4	RW
2817	P10.67	<b>PID1 Hysteresis Level</b> PID1 hysteresis level.	2, 3, 4	RW
2825	P10.68	<b>PID1 Backup Feedback Source</b> PID1 backup feedback source.	2, 3, 4	RW
1356	P11.1	<b>PID2 Control Gain</b> Defines the gain of the PID controller. It adjust the slope of the speed increase according to the initial of the load. If this value is set to 100%, a change of 10% in the error value causes the controller output to change 10%.	3, 4	RW
1357	P11.2	<b>PID2 Control I Time</b> Defines the integration time of the PID controller. Over the time the integral time contributes to the deviation between the reference and the feedback signal. If this value is set to 1.00 sec., a change of 10% in the error value causes the controller output to change by 10.00%/s. With value set to 0.0, frequency converter operates as PD controller.	3, 4	RW
1358	P11.3	<b>PID2 Control D Time</b> Defines the derivation time of the PID controller. This value will adjust the rate of change on the feedback signal. If this value is set to 1.00 sec., a change of 10% in error value during 1.00 sec. causes the control output to change by 10.00%. If value is set to 0.0, frequency converter operates as PI controller.	3, 4	RW
1359	P11.4	<b>PID2 Process Unit</b> Defines the unit type for PID feedback unit.	3, 4	RW
1360	P11.5	<b>PID2 Process Unit Min</b> Defines the minimum process unit value.	3, 4	RW
1362	P11.6	<b>PID2 Process Unit Max</b> Defines the maximum process unit value.	3, 4	RW
1364	P11.7	<b>PID2 Process Unit Decimal</b> Defines the amount of decimal places in process unit value.	3, 4	RW
1365	P11.8	<b>PID2 Error Inversion</b> Defines the way the process value output reacts to the feedback signal. 0 = Normal - If feedback is less than set-point, PID controller output increases. 1 = Inverted - If feedback is less than set-point, PID controller output decreases.	3, 4	RW
1366	P11.9	<b>PID2 Dead Band</b> PID dead band around set-point in process units. This is the band where no actions occur, to prevent oscillation or repeated activation/deactivation of controller. The PID output is locked if the feedback stays within the dead band area.	3, 4	RW



Modbus ID	Code	Parameters	Application	RO/RW
1368	P11.10	<b>PID2 Dead Band Delay</b> If the PID process value goes out of the dead band area for the desired time delay at that point the controller will re-initialize and try to level out again.	3, 4	RW
1369	P11.11	<b>PID2 Keypad Set Point 1</b> Keypad PID reference value set point 1.	3, 4	RW
1371	P11.12	<b>PID2 Keypad Set Point 2</b> Keypad PID reference value set point 2.	3, 4	RW
1373	P11.13	<b>PID2 Ramp Time</b> Defines the rising and falling ramp times for changes in the process value.	3, 4	RW
1374	P11.14	<b>PID2 Set Point 1 Source</b> Defines source of the set point value the drive uses this can either be an internal preset value, keypad set point, analog signal or Fieldbus message.	3, 4	RW
1375	P11.15	<b>PID2 Set Point 1 Min</b> Defines minimum value for the set-point 1 source.	3, 4	RW
1376	P11.16	<b>PID2 Set Point 1 Max</b> Defines maximum value for the set-point 1 source.	3, 4	RW
1377	P11.17	<b>PID2 Sleep Enable When Using Set Point 1</b> Enable PID set-point sleep mode. This function will disable the output when the frequency drops below, or increase above, depend on application the sleep frequency for the sleep delay time. The output re-engages when feedback rises above the wakeup level.	3, 4	RW
2398	P11.18	<b>PID2 Sleep Level Unit When Using Set Point 1</b> PID2 set-point 1 sleep unit defines what value would be looked at when drive is going into the sleep mode when the motor is not required to run. 0 = Output frequency 1 = Motor speed 2 = Motor current 3 = PID1 feedback	3, 4	RW
2454	P11.19	<b>PID2 Set Point When Using Set Point 1</b> Defines the level of which the unit value is used to look at to go into the sleep mode. When the unit drops below this level for the sleep delay time, it will put the drive into the sleep mode.	3, 4	RW
1379	P11.20	<b>PID2 Sleep Delay When Using Set Point 1</b> This parameter sets the delay time after the set-point drops below the sleep level for this amount of time and then the drives output will shut off till the wakeup level is met. It is to prevent large fluctuations when going into the sleep function to save motor run time.	3, 4	RW
1380	P11.21	<b>PID2 Wake Up Level When Using Set Point 1</b> Defines the level for the PID feedback value to go above top enable the PID output to be re enabled. This value is based of the % of feedback which can be scaled based off the PID unit Min/Max values.	3, 4	RW
1382	P11.22	<b>PID2 Set Point 1 Boost</b> The set-point can be boosted via a multiplier value.	3, 4	RW
1383	P11.23	<b>PID2 Set Point 2 Source</b> Defines source of the set-point value the drive uses this can either be an internal preset value, keypad set-point, analog signal or Fieldbus message.	3, 4	RW
1384	P11.24	<b>PID2 Set Point 2 Min</b> Defines minimum value for the set-point 2 source.	3, 4	RW
1385	P11.25	<b>PID2 Set Point 2 Max</b> Defines maximum value for the set-point 2 source.	3, 4	RW
1386	P11.26	<b>PID2 Sleep Enable When Using Set Point 2</b> Enable PID set-point sleep mode. This function will disable the output when the frequency drops below, or increase above, depend on application the sleep frequency for the sleep delay time. The output re-engages when feedback rises above the wakeup level.	3, 4	RW

## Appendix A—Description of parameters

Modbus ID	Code	Parameters	Application	RO/RW
2399	P11.27	<b>PID2 Sleep Level Unit When Using Set Point 2</b> Defines what value would be looked at when drive is going into the sleep mode when the motor is not required to run. 0 = Output frequency 1 = Motor speed 2 = Motor current 3 = PID1 feedback	3, 4	RW
2456	P11.28	<b>PID2 Sleep Level When Using Set Point 2</b> Defines the level of which the unit value is used to look at to go into the sleep mode. When the unit drops below this level for the sleep delay time, it will put the drive into the sleep mode.	3, 4	RW
1388	P11.29	<b>PID2 Sleep Delay When Using Set Point 2</b> This parameter sets the delay time after the set-point drops below the sleep level for this amount of time and then the drives output will shut off till the wakeup level is met. It is to prevent large fluctuations when going into the sleep function to save motor run time.	3, 4	RW
1389	P11.30	<b>PID2 Wakeup Level when Using Set Point 2</b> Defines the level for the PID feedback value to go above to enable the PID output to be re-enabled. This value is based of the % of feedback which can be scaled based off the PID unit Min/Max values.	3, 4	RW
1391	P11.31	<b>PID2 Set Point 2 Boost</b> The set-point can be boosted via a multiplier value.	3, 4	RW
1392	P11.32	<b>PID2 Feedback Func</b> Choose a single signal used as feedback, this parameter allows for doing math functions with 2 sources.	3, 4	RW
1393	P11.33	<b>PID2 Feedback Gain</b> Define gain associated with feedback signal from the measuring device.	3, 4	RW
1394	P11.34	<b>PID2 Feedback 1 Source</b> Define where feedback signal is being fed into the drive, via analog or Fieldbus data value.	3, 4	RW
1395	P11.35	<b>PID2 Feedback 1 Min</b> Minimum unit value for the feedback signal.	3, 4	RW
1396	P11.36	<b>PID2 Feedback 1 Max</b> Maximum unit value for the feedback signal.	3, 4	RW
1397	P11.37	<b>PID2 Feedback 2 Source</b> Define where feedback signal is being fed into the drive, via analog or Fieldbus data value.	3, 4	RW
1398	P11.38	<b>PID2 Feedback 2 Min</b> Minimum unit value for the feedback signal.	3, 4	RW
1399	P11.39	<b>PID2 Feedback 2 Max</b> Maximum unit value for the feedback signal.	3, 4	RW
1400	P11.40	<b>PID2 Feedforward Func</b> Choose a single signal used as feed forward command. This is used to account for major disturbances that the processor does not see via the feedback.	3, 4	RW
1401	P11.41	<b>PID2 Feedforward Gain</b> Define feed forward gain control level.	3, 4	RW
1402	P11.42	<b>PID2 Feedforward 1 Source</b> Define from where feed forward signal is fed. This can either be an analog signal or Fieldbus process value.	3, 4	RW
1403	P11.43	<b>PID2 Feedforward 1 Min</b> Define feed forward minimum value setting.	3, 4	RW
1404	P11.44	<b>PID2 Feedforward 1 Max</b> Define feed forward maximum unit value setting.	3, 4	RW
1405	P11.45	<b>PID2 Feedforward 2 Source</b> Define from where feed forward signal is fed. This can either be an analog signal or Fieldbus process value.	3, 4	RW
1406	P11.46	<b>PID2 Feedforward 2 Min</b> Define feed forward minimum value setting.	3, 4	RW

Modbus ID	Code	Parameters	Application	RO/RW
1407	P11.47	<b>PID2 Feedforward 2 Max</b> Define feed forward maximum unit Value setting.	3, 4	RW
1414	P11.48	<b>PID2 Set Point1 Comp Enable</b> Enables pressure loss compensation for set-point 1 signal value.	3, 4	RW
1415	P11.49	<b>PID2 Set Point1 Comp Max</b> Value added proportionally to the frequency, set-point compensation = comp max * (output freq–min freq)/(max freq–min freq). Refer P11.51 for procedure for setting up PID application.	3, 4	RW
1416	P11.50	<b>PID2 Set Point 2 Comp Enable</b> Enables pressure loss compensation for set-point 2 signal value.	3, 4	RW
1417	P11.51	<b>PID2 Set Point 2 Comp Max</b> Value added proportionally to the frequency, set-point compensation = comp max * (output freq–min freq)/(max freq–min freq).	3, 4	RW

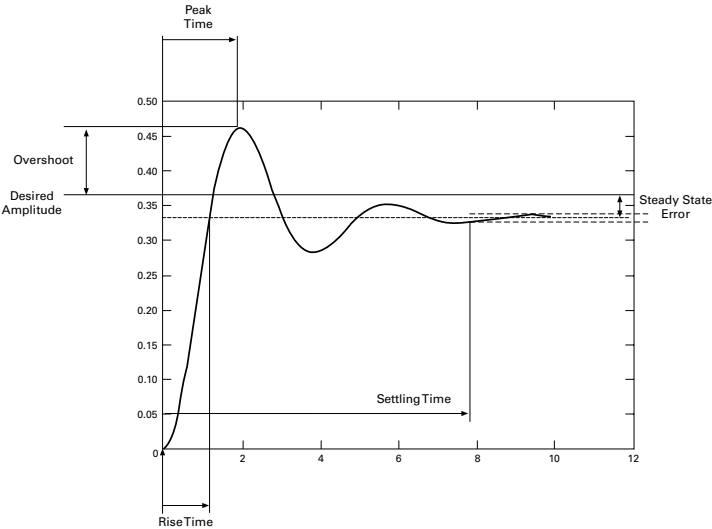
**Procedure for setting up PID application.**

Initially set PID gain (P11.1) to 0.0% and set the PID I time (P11.2) to 20 sec. Start the frequency converter and verify if the set-point is reached quickly while maintaining stable operation of the system. If not, increase the PID gain (P11.1) until the drive speed oscillates constantly. After this occurs, reduce the PID gain (P11.1) slightly to reduce the oscillation. From here, take the value found for PID gain (P11.1) to 0.5 times that value and reduce the PID I time (P11.2) until the feedback signal oscillates again. Increase the PID I time (P11.2) until the oscillation stops, with that value take it times 1.2 and use that value for the PID I time (P11.2). If signal noise is seen at high frequency, increase the filter time values to filter the signal. If further tuning is required, refer to the table showing what is effected.

2467	P11.52	<b>PID2 Wakeup Action</b> This parameter defines the wakeup function action. 0 - Wakeup when below wakeup level P11.21/P11.30. 1 - Wakeup when above wakeup level P11.21/P11.30. 2 - Wakeup when below wakeup level % set in P11.21/P11.30 from PID set-point. 3 - Wakeup when above wakeup level % set in P11.21/P11.30 from PID set-point.	3, 4	RW
------	--------	---	------	----

Response	Rise time	Overshoot	Settling time	Steady state error
Increase PID Gain	Decrease Rise	Increases Overshoot	Not Affected	Decreases Error
Increase PID1 Time	Decrease Rise	Increases Overshoot	Increases Setting	Eliminates Error
Increase PID0 Time	Not Affected	Decreases Overshoot	Decreases Setting	Not Affected

Rise time—the time required for the output to rise 90% of the desired level for the first time.  
Overshoot—the difference between the peak level and the steady state level. Settling time—time required for the system to converge to its steady state.  
Steady state error—the difference between the steady state level and the desired output level.



## Appendix A—Description of parameters

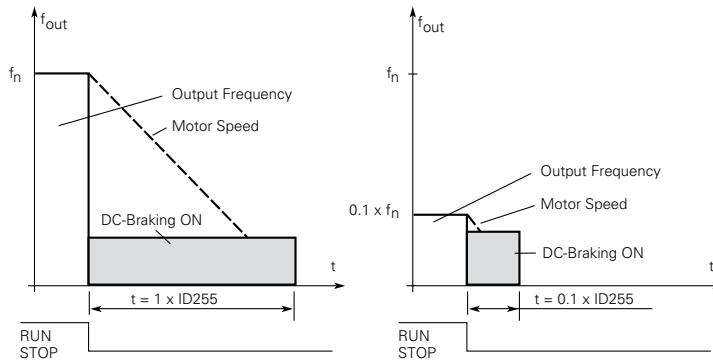
Modbus ID	Code	Parameters	Application	RO/RW
2546	P11.53	<b>FB PID2 Set Point 1</b> PID set-point 1 value from Fieldbus.	3, 4	RW
2548	P11.54	<b>FB PID2 Set Point 2</b> PID setpoint 2 value from Fieldbus.	3, 4	RW
2552	P11.55	<b>FB PID2 Feedback 1</b> PID feedback 1 value from Fieldbus.	3, 4	RW
2553	P11.56	<b>FB PID2 Feedback 2</b> PID reference value feedback 2 from Fieldbus.	3, 4	RW
2556	P11.57	<b>FB PID2 Feedforward 1</b> PID reference value feed forward 1 from Fieldbus.	3, 4	RW
2557	P11.58	<b>FB PID2 Feedforward 2</b> PID reference value feed forward 2 from Fieldbus.	3, 4	RW
2662	P11.59	<b>PID2 Sleep Boost level</b> PID2 sleep boost level.	3, 4	RW
2663	P11.60	<b>PID2 Sleep Boost Max Time</b> PID2 sleep boost max. time.	3, 4	RW
2818	P11.61	<b>PID2 Low Feedback Level</b> PID2 low feedback level.	3, 4	RW
2819	P11.62	<b>PID2 Low Feedback Time</b> PID2 low feedback time.	3, 4	RW
2820	P11.63	<b>PID2 Low Feedback Protection</b> PID2 low feedback protection.	3, 4	RW
2821	P11.64	<b>PID2 High Feedback Level</b> PID2 high feedback level.	3, 4	RW
2822	P11.65	<b>PID2 High Feedback Time</b> PID2 high feedback time.	3, 4	RW
2823	P11.66	<b>PID2 High Feedback Protection</b> PID2 high feedback protection.	3, 4	RW
2824	P11.67	<b>PID2 Hysteresis Level</b> PID2 hysteresis level.	3, 4	RW
2826	P11.68	<b>PID2 Backup Feedback Source</b> PID2 backup feedback source.	3, 4	RW
105	P12.1	<b>Preset Speed 1</b> Preset speed is selected with digital inputs using a binary input. Parameter values are automatically limited between the minimum and maximum frequencies (P1.1, P1.2).	1, 2, 3, 4	RW
106	P12.2	<b>Preset Speed 2</b> Preset speed is selected with digital inputs using a binary input. Parameter values are automatically limited between the minimum and maximum frequencies (P1.1, P1.2).	1, 2, 3, 4	RW
118	P12.3	<b>Preset Speed 3</b> Preset speed is selected with digital inputs using a Binary input. Parameter values are automatically limited between the minimum and maximum frequencies (P1.1, P1.2).	1, 2, 3, 4	RW
119	P12.4	<b>Preset Speed 4</b> Preset speed is selected with digital inputs using a Binary input. Parameter values are automatically limited between the minimum and maximum frequencies (P1.1, P1.2).	1, 2, 3, 4	RW
120	P12.5	<b>Preset Speed 5</b> Preset speed is selected with digital inputs using a Binary input. Parameter values are automatically limited between the minimum and maximum frequencies (P1.1, P1.2).	1, 2, 3, 4	RW
121	P12.6	<b>Preset Speed 6</b> Preset speed is selected with digital inputs using a Binary input. Parameter values are automatically limited between the minimum and maximum frequencies (P1.1, P1.2).	1, 2, 3, 4	RW
122	P12.7	<b>Preset Speed 7</b> Preset speed is selected with digital inputs using a Binary input. Parameter values are automatically limited between the minimum and maximum frequencies (P1.1, P1.2).	1, 2, 3, 4	RW

Modbus ID	Code	Parameters	Application	RO/RW
295	P13.1	<b>Torque Limit</b> With this parameter you can set the torque limit control limit between 0.0–400.0% when in open loop torque control.	4	RW
303	P13.2	<b>Torque Ref Select</b> Defines the source for torque reference. 0 = Not used 1 = AI1 2 = AI2 3 = SlotA:AI1 4 = SlotB:AI1 5 = AI1 joystick 6 = AI2 joystick 7 = Keypad torque ref. 8 = Fieldbus ref.	4	RW
782	P13.3	<b>Keypad Torque Ref</b> Keypad torque speed reference.	4	RW
304	P13.4	<b>Torque Ref Max</b> Scales the minimum and maximum level for the torque ref to be between –300.0 to 300.0%.	4	RW
305	P13.5	<b>Torque Ref Min</b> Scales the minimum and maximum level for the torque ref to be between –300.0 to 300.0%.	4	RW
1666	P13.6	<b>Speed Limiter Mode</b> Defines the speed limit control which the frequency converter operates in the open loop torque control mode. 0 = NegFreqMax...PosFreqMax 1 = - FreqRampOut ...+ FreqRampOut  2 = NegFreqMax...FreqRampout(MIN) 3 = FreqRampOut...PosFreqMax(MAX) 4 = FreqRampOut+-WindowPos/NegWidth 5 = 0...FreqRampOut(pos or neg direction) 6 = FreqRamp+-WindowPos/Neg/PosOff/NegOff	4	RW
1636	P13.7	<b>Window Pos Width</b> Frequency in positive direction when drive goes into speed control from torque control mode. This references back to P13.6 setting for the frequency max. set-point option 4 or 6.	4	RW
1637	P13.8	<b>Window Neg Width</b> Frequency in negative direction when drive goes into speed control from torque control mode. This references back to P13.6 setting for the frequency max. set-point option 4 or 6.	4	RW
1638	P13.9	<b>Window Pos Off Limit</b> Frequency in positive direction when drive comes out of speed control from torque control mode. This references back to P13.6 setting for the frequency max. set-point option 6.	4	RW
1639	P13.10	<b>Window Neg Off Limit</b> Frequency in negative direction when drive comes out of speed control from torque control mode. This references back to P13.6 setting for the frequency max. set-point option 6.	4	RW
1640	P13.11	<b>Torque Reference Filter TC</b> Torque reference filter time.	4	RW
1606	P13.12	<b>Pull Out Torque</b> Start up torque level in percentage.	4	RW
1684	P13.13	<b>Stop State Magnetization Time</b> Engine stop-magnetization time at the stop in the open-loop torque control mode.	4	RW
2541	P13.14	<b>FB Torque Ref</b> Torque reference from Fieldbus.	4	RW
254	P14.1	<b>DC-Brake Current</b> Defines the current level injected into the motor during DC-braking.	1, 2, 3, 4	RW

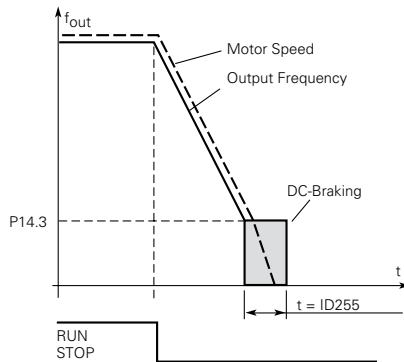
## Appendix A—Description of parameters

Modbus ID	Code	Parameters	Application	RO/RW
263	P14.2	<b>Start DC-Brake Time</b> This parameter defines the time the drive injects DC braking current before starting to ramp. This can be used to stop motors that are potentially spinning before a run command is given, before ramping to reference level. This is to stop motors that are potentially spinning before a run command is given.	1, 2, 3, 4	RW
262	P14.3	<b>Stop DC-Brake Frequency</b> During a ramp to stop this parameter defines the output frequency to be below to begin DC-braking.	1, 2, 3, 4	RW
255	P14.4	<b>Stop DC-Brake Time</b> Determines the length of DC braking while stopping. 0.00 = DC-brake is not used. >0.0 = The amount of time DC-braking will occur after falling below the stop DC brake frequency.	1, 2, 3, 4	RW

**Figure 91. DC-braking time when stop mode = coasting.**



**Figure 92. DC-braking time when stop mode = ramp.**



251	P14.5	<b>Brake Chopper Mode</b> When the frequency converter is decelerating the motor, the inertia of the motor and the load is fed into an external brake resistor. This enables the frequency converter to decelerate the load with a torque equal to that of acceleration (provided that the correct brake resistor has been selected). 0 = No brake chopper used. 1 = Brake chopper in use and tested when running. Can be tested also in READY state. 2 = External brake chopper (no testing). 3 = Used and tested in READY state and when running. 4 = Used when running (no testing).	1, 2, 3, 4	RW
-----	-------	---	------------	----

Modbus ID	Code	Parameters	Application	RO/RW
266	P14.6	<p><b>Flux Brake</b></p> <p>while stopping the output frequency is reduced and the flux in the motor is increased, which in turn increases the motor's capability to brake. Unlike DC braking, the motor speed remains controlled during braking.</p> <p>The flux braking can be set ON or OFF.</p> <p>0 = Flux braking OFF</p> <p>1 = Flux braking ON</p> <p><b>Note:</b> Flux braking converts the energy into heat in the motor, and should be used carefully to avoid motor damage flux braking is a useful form of braking for motors ≤15 kW.</p>	1, 2, 3, 4	RW
265	P14.7	<p><b>Flux Brake Current</b></p> <p>Defines the flux braking current value output when flux brake is enabled.</p>	1, 2, 3, 4	RW
535	P15.1	<p><b>Fire Mode Function</b></p> <p>This parameter determines whether the fire mode function is determined by a contact closure or contact opening on the desired digital input function (P3.28) select fire mode.</p> <p>0 = Closing contact initiates fire mode function.</p> <p>1 = Opening contact initiates fire mode function.</p> <p><b>Note:</b> when fire mode is enabled, this causes the drive to ignore any fault and run till its death. Warranty will be non-valid in the case this is enabled and the drive causes issues to the system.</p>	2, 3, 4	RW
536	P15.2	<p><b>Fire Mode Ref Select Function</b></p> <p>This parameter allows for setting the reference location for when the fire mode is enabled.</p> <p>0 = Fire mode min. frequency (P15.3)</p> <p>1 = Fire mode ref. - Follows P15.4 and P15.5 with the use of an digital input to select</p> <p>2 = Fieldbus ref. - Reference from Fieldbus process in</p> <p>3 = AI1 - Analog input 1</p> <p>4 = AI2 - Analog input 2</p> <p>5 = AI1 + AI2 - Analog input 1 added to analog input 2</p> <p>6 = PID1 control output</p> <p>7 = PID2 control output</p>	2, 3, 4	RW
537	P15.3	<p><b>Fire Mode Frequency</b></p> <p>This parameter sets the minimum output frequency for fire mode. This can be used as a selection for reference command.</p>	2, 3, 4	RW
565	P15.4	<p><b>Fire Mode % Speed Ref 1</b></p> <p>This parameter sets the drive operating percentage based off the 0% being min. frequency and 100% being max. frequency (P1.2) for fire mode reference 1.</p>	2, 3, 4	RW
564	P15.5	<p><b>Fire Mode % Speed Ref 2</b></p> <p>This parameter sets the drive operating percentage based off the 0% being min. frequency and 100% being max. frequency (P1.2) for fire mode reference 2.</p>	2, 3, 4	RW
554	P15.6	<p><b>Smoke Purge Frequency</b></p> <p>Frequency setting for smoke purge. Preset speed used for a digital input selection. The percentage is based off the 0% being min. frequency (P1.1) and 100% being max. frequency (P1.2).</p>	2, 3, 4	RW
2443	P15.7	<p><b>Fire Mode Test Enable</b></p> <p>This parameter allows for testing the fire mode feature. With the parameter set to enable and fire mode input enabled, the drive will run at the fire mode speed desired but all faults are enabled.</p>	2, 3, 4	RW
577	P16.1	<p><b>Motor Nom Current 2</b></p> <p>The second motor set name plate current. Selected based off of a digital input.</p>	2, 3, 4	RW
578	P16.2	<p><b>Motor Nom Speed 2</b></p> <p>The second motor set name plate RPM. Selected based off of a digital input.</p>	2, 3, 4	RW
579	P16.3	<p><b>Motor PF 2</b></p> <p>The second motor set name plate power factor. Selected based off of a digital input.</p>	2, 3, 4	RW
580	P16.4	<p><b>Motor Nom Volt 2</b></p> <p>The second motor set name plate voltage. Selected based off of a digital input.</p>	2, 3, 4	RW
581	P16.5	<p><b>Motor Nom Freq 2</b></p> <p>The second motor set name plate frequency. Selected based off of a digital input.</p>	2, 3, 4	RW
1419	P16.6	<p><b>Stator Resistor 2</b></p> <p>The second set of motor stator resistor real values for 2nd motor set.</p>	2, 3, 4	RW

## Appendix A—Description of parameters

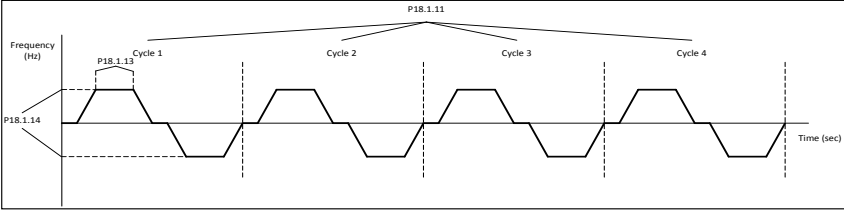
Modbus ID	Code	Parameters	Application	RO/RW
1420	P16.7	<b>Rotor Resistor 2</b> The second set of motor rotor resistor real values for 2nd motor set.	4	RW
1421	P16.8	<b>Leak Inductance 2</b> The second set of motor leakage inductance real values for 2nd motor set.	4	RW
1422	P16.9	<b>Mutual Inductance 2</b> The second set of motor mutual inductance real values for 2nd motor set.	4	RW
1423	P16.10	<b>Excitation Current 2</b> The second set of motor no-load current real values for 2nd motor set.	4	RW
2838	P16.11	<b>Motor Inertia2</b> Motor Inertia2.	4	RW
2842	P16.12	<b>Second PM BEMF Voltage</b> Second PM BEMF voltage.	4	RW
2843	P16.13	<b>Second PM Q-axis Stator Inductance</b> Second PM q-axis stator inductance.	4	RW
2844	P16.14	<b>Second PM D-axis Stator Inductance</b> Second PM d-axis stator inductance.	4	RW
1418	P17.1.1	<b>Bypass Enable</b> This parameter identifies whether enter into bypass mode is enabled. Once enabled, the “Bypass” soft key on keypad will show to start bypass.	2, 3, 4	RW
544	P17.1.2	<b>Bypass Start Delay</b> This parameter specifies the time delay between when the bypass signal is applied via I/O, Fieldbus, or keypad, to when the motor starts and once bypass is removed the time to switch back to drive.	2, 3, 4	RW
542	P17.1.3	<b>Auto Bypass</b> This parameter specifies whether an automatic switch to bypass will occur based on fault condition, is enabled based off a specific fault condition of auto bypass through fault auto bypass parameters below. 0 = Auto bypass disabled. 1 = Auto bypass enabled.	2, 3, 4	RW
543	P17.1.4	<b>Auto Bypass Delay</b> This parameter specifies the time delay before an automatic switch to bypass, as determined by over-voltage fault auto bypass through under-voltage fault auto bypass parameters, will occur.	2, 3, 4	RW
547	P17.1.5	<b>OverCurrent Bypass Enable</b> This parameter specifies whether an automatic switch to bypass will occur after the over-current fault auto-restart tries have been exceeded. 0 = Auto bypass on over-current fault tries exceeded disabled, bypass once fault happens. 1 = Auto bypass on over-current fault tries exceeded enabled, bypass after tries exceed.	2, 3, 4	RW
546	P17.1.6	<b>IGBT Fault Bypass Enable</b> This parameter specifies whether an automatic switch to bypass will occur after the IGBT fault auto-restart tries have been exceeded. 0 = Auto bypass on IGBT fault tries exceeded disabled. 1 = Auto bypass on IGBT fault tries exceeded enabled.	2, 3, 4	RW
548	P17.1.7	<b>4 mA Fault Bypass Enable</b> This parameter specifies whether an automatic switch to bypass will occur after the loss of reference fault and auto-restart tries have been exceeded. 0 = Auto bypass on loss of reference fault tries exceeded disabled. 1 - Auto bypass on loss of reference fault tries exceeded enabled. <b>Note:</b> 4 mA input fault (P9.1) must be set to 4 or 5 (fault) and 4 mA fault attempts (P9.30) >0.	2, 3, 4	RW
545	P17.1.8	<b>UnderVoltage Bypass Enable</b> This parameter specifies whether an automatic switch to bypass will occur after the under-voltage fault auto-restart tries have been exceeded. 0 = Auto bypass on under-voltage fault tries exceeded disabled. 1 = Auto bypass on under-voltage fault tries exceeded enabled.	2, 3, 4	RW



Modbus ID	Code	Parameters	Application	RO/RW
549	P17.1.9	<b>OverVoltage Bypass Enable</b> This parameter specifies whether an automatic switch to bypass will occur after the over-voltage fault auto-restart tries have been exceeded. 0 = Auto bypass on over-voltage fault tries exceeded disabled. 1 = Auto bypass on over-voltage fault tries exceeded enabled.	2, 3, 4	RW
1698	P17.1.10	<b>Motor OverTemp Bypass Enable</b> Motor over-temp bypass enable.	2, 3, 4	RW
1699	P17.1.11	<b>UnderLoad Bypass Enable</b> Under-load bypass enable.	2, 3, 4	RW
1700	P17.1.12	<b>External Bypass Enable</b> External bypass enable.	2, 3, 4	RW
1701	P17.1.13	<b>Charge Switch Fault Bypass Enable</b> Charge switch fault bypass enable.	2, 3, 4	RW
1702	P17.1.14	<b>Saturation Trip Fault Bypass Enable</b> Saturation trip fault bypass enable.	2, 3, 4	RW
1703	P17.1.15	<b>Under Temp Fault Bypass Enable</b> Under temp fault bypass enable.	2, 3, 4	RW
1704	P17.1.16	<b>EEPROM Fault Bypass Enable</b> EEPROM fault bypass enable.	2, 3, 4	RW
1705	P17.1.17	<b>Control Board EEPROM Fault Bypass Enable</b> Control board EEPROM fault bypass enable.	2, 3, 4	RW
1706	P17.1.18	<b>Watchdog Fault Bypass Enable</b> Watchdog fault bypass enable.	2, 3, 4	RW
1707	P17.1.19	<b>Fan Cooling Fault Bypass Enable</b> Fan cooling fault bypass enable.	2, 3, 4	RW
1708	P17.1.20	<b>Keypad Com Fault Bypass Enable</b> Keypad com. fault bypass enable.	2, 3, 4	RW
1709	P17.1.21	<b>Option Card Fault Bypass Enable</b> Option card fault bypass enable.	2, 3, 4	RW
1710	P17.1.22	<b>RTC Clock Fault Bypass Enable</b> RTC clock fault bypass enable.	2, 3, 4	RW
1711	P17.1.23	<b>Ctrl Board OverTemp Fault Bypass Enable</b> Ctrl. board over-temp fault bypass enable	2, 3, 4	RW
1713	P17.1.24	<b>Fieldbus Fault Bypass Enable</b> Fieldbus fault bypass enable.	2, 3, 4	RW
2832	P17.1.25	<b>Op Cont Interlock Fault Bypass Enable</b> Op cont. interlock fault bypass enable.	2, 3, 4	RW
2476	P17.2.1	<b>Redundant Drive Enable</b> This parameter will allow for enabling the redundant drive setup were multiple drives can be connected via modbus communications to start if the main drive fails or runtime settings below expires.	2, 3, 4	RW
2278	P17.2.2	<b>Drive ID</b> This parameter defines the drive address when using multi-drive pump mode. Based off this ID, the drive enables in the desired sequence and can be monitored at this drive ID value in the monitor screen.	2, 3, 4	RW
2477	P17.2.3	<b>Redundant Run Time Enable</b> This parameter enables the run time limit on the redundant drive so that drives will be cycled based off the run time limit value.	2, 3, 4	RW
2478	P17.2.4	<b>Redundant Run Time Reset</b> This parameter will reset the redundant drive run timer value.	2, 3, 4	RW
2479	P17.2.5	<b>Redundant RunTime Limit</b> Sets the time limit for the run time of one drive when enabled for the redundant drive scheme.	2, 3, 4	RW

## Appendix A—Description of parameters

Modbus ID	Code	Parameters	Application	RO/RW
2279	P18.1.1	<p><b>Multi-pump Mode</b></p> <p>Determines the number of drives being used in the multi-pump configuration.</p> <p>0 = Single drive - Single drive for main motor, contractors used on other motors.</p> <p>1 = Multi-drive - Multi-follower sequence with multiple drives.</p>	2, 3, 4	RW
2278	P18.1.2	<p><b>Drive ID</b></p> <p>This parameter defines the drive address when using multi-drive pump mode. Based off this ID, the drive enables in the desired sequence and can be monitored at this drive ID value in the monitor screen.</p>	2, 3, 4	RW
2458	P18.1.3	<p><b>PID Bandwidth</b></p> <p>Percentage based off the set-point above and below which defines when the aux. motor will come online or offline.</p>	2, 3, 4	RW
2315	P18.1.4	<p><b>Staging Frequency</b></p> <p>Output frequency is above staging frequency and PID error is out of PID bandwidth. Motor should add to system.</p>	2, 3, 4	RW
2316	P18.1.5	<p><b>De-Staging Frequency</b></p> <p>Output frequency is below de-staging frequency and PID error is out of PID bandwidth. Motor should remove from system.</p>	2, 3, 4	RW
344	P18.1.6	<p><b>Add/Remove Delay</b></p> <p>With feedback outside the bandwidth, this time must pass before motors/pumps are added or removed from the system.</p>	2, 3, 4	RW
350	P18.1.7	<p><b>Interlock Enable</b></p> <p>This parameter enables the drive to look at the digital input interlocks to tell which motor is available for running or if they were brought offline.</p>	2, 3, 4	RW
483	P18.1.8	<p><b>Damper Start</b></p> <p>This parameter determines the function of the damper.</p> <p>0 = Start - Standard start.</p> <p>1 = Interlocked start - To use this, a relay output, RO1/RO2, needs to be programmed for selections 29 "Damper Control," and a digital input function must be programmed for selection "RunEnable". The relay output is used to energize an element of the driven system, such as a damper, seal water solenoid, or a pre-lube pump. Upon a return acknowledgement contact closure to the programmed digital input, the frequency converter will start.</p> <p>2 = Interlock time start - This functions the same as the interlocked start, except that if the return acknowledgement contact is not received within the interlock timeout, a "prevent-up start" fault is displayed in keypad and the start sequence will need to be restarted.</p> <p>3 = Delay start - This start is similar to the interlocked start, except that a return contact is not used. After the "delay time" following the relay output closure, the frequency converter starts.</p>	2, 3, 4	RW
484	P18.1.9	<p><b>Damper Time Out</b></p> <p>The time out time used for an interlocked time start, after which the start sequence must be restarted if no acknowledgment contact is received.</p>	2, 3, 4	RW
485	P18.1.10	<p><b>Damper Delay</b></p> <p>The delay time following a delay start, after which the frequency converter will be started.</p>	2, 3, 4	RW
2468	P18.1.11	<p><b>Derag Cycles</b></p> <p>This parameter defines the number of cycles in the forward/reverse direction for removing any debris in system.</p>	2, 3, 4	RW
2469	P18.1.12	<p><b>Derag at Start/Stop</b></p> <p>Defines how the Derag function will become activated; start, stop, both, or based off the digital input.</p>	2, 3, 4	RW
2470	P18.1.13	<p><b>Deragging Run Time</b></p> <p>Defines the length of time the drive will run at the Derag speed in the forward and reverse direction.</p>	2, 3, 4	RW

Modbus ID	Code	Parameters	Application	RO/RW
2471	P18.1.14	<p><b>Derag Speed</b></p> <p>Defines the frequency the drive will run at in the forward/reverse direction when in the Derag mode.</p> 	2, 3, 4	RW
2472	P18.1.15	<p><b>Derag Off Delay</b></p> <p>Defines the length of time the drive will run the Derag function when enabled at stop.</p>	2, 3, 4	RW
2659	P18.1.16	<p><b>Multi-pump Mode 2</b></p> <p>Determines the number of drives being used in the multi-pump configuration.</p> <p>0 = Single drive - Single drive for main motor, contractors used on other motors.</p> <p>1 = Multi-drive - Multi-follower sequence with multiple drives.</p>	2, 3, 4	RW
2218	P18.2.1.1	<p><b>MPC Drive1 Operate Mode</b></p> <p>Provides the operating mode of drive 1 while using multi-pump mode.</p> <p>0 = Offline</p> <p>1 = Slave drive</p> <p>2 = Master drive</p> <p>3 = Redundant drive.</p>	2, 3, 4	RO
2230	P18.2.1.2	<p><b>MPC Drive2 Operate Mode</b></p> <p>Provides the operating mode of drive 2 while using multi-pump mode.</p> <p>See Par ID 2218.</p>	2, 3, 4	RO
2242	P18.2.1.3	<p><b>MPC Drive3 Operate Mode</b></p> <p>Provides the operating mode of drive 3 while using multi-pump mode.</p> <p>See Par ID 2218.</p>	2, 3, 4	RO
2254	P18.2.1.4	<p><b>MPC Drive4 Operate Mode</b></p> <p>Provides the operating mode of drive 4 while using multi-pump mode.</p> <p>See Par ID 2218.</p>	2, 3, 4	RO
2266	P18.2.1.5	<p><b>MPC Drive5 Operate Mode</b></p> <p>Provides the operating mode of drive 5 while using multi-pump mode.</p> <p>See Par ID 2218.</p>	2, 3, 4	RO
2219	P18.2.2.1	<p><b>MPC Drive1 Status</b></p> <p>Provides the run status of drive 1 while using the multi-pump mode.</p> <p>0 = Stopped</p> <p>1 = Sleep</p> <p>2 = Regulating</p> <p>3 = Wait for CMD</p> <p>4 = Following</p> <p>5 = Unknown</p> <p>6 = Local control</p> <p>7 = Local control.</p>	2, 3, 4	RO
2231	P18.2.2.2	<p><b>MPC Drive2 Status</b></p> <p>Provides the run status of drive 2 while using the multi-pump mode.</p> <p>See Par ID 2219.</p>	2, 3, 4	RO
2243	P18.2.2.3	<p><b>MPC Drive3 Status</b></p> <p>Provides the run status of drive 3 while using the multi-pump mode.</p> <p>See Par ID 2219.</p>	2, 3, 4	RO
2255	P18.2.2.4	<p><b>MPC Drive4 Status</b></p> <p>Provides the run status of drive 4 while using the multi-pump mode.</p> <p>See Par ID 2219.</p>	2, 3, 4	RO

## Appendix A—Description of parameters

Modbus ID	Code	Parameters	Application	RO/RW
2267	P18.2.2.5	<b>MPC Drive5 Status</b> Provides the run status of drive 5 while using the multi-pump mode. See Par ID 2219.	2, 3, 4	RO
2220	P18.2.3.1	<b>MPC Drive1 Network Status</b> Provides the network status of drive 1 while using the multi-pump mode. 0 = Disconnected 1 = Fault 2 = Local control 3 = Pump lost 4 = Need alternation 5 = No error.	2, 3, 4	RO
2232	P18.2.3.2	<b>MPC Drive2 Network Status</b> Provides the network status of drive 2 while using the multi-pump mode. See Par ID 2220.	2, 3, 4	RO
2244	P18.2.3.3	<b>MPC Drive3 Network Status</b> Provides the network status of drive 3 while using the multi-pump mode. See Par ID 2220.	2, 3, 4	RO
2256	P18.2.3.4	<b>MPC Drive4 Network Status</b> Provides the network status of drive 4 while using the multi-pump mode. See Par ID 2220.	2, 3, 4	RO
2268	P18.2.3.5	<b>MPC Drive5 Network Status</b> Provides the network status of drive 5 while using the multi-pump mode. See Par ID 2220.	2, 3, 4	RO
2221	P18.3.1.1	<b>MPC Drive1 Last Fault Code</b> Provides the latest fault code of drive 1 while using the multi-pump mode.	2, 3, 4	RO
2233	P18.3.1.2	<b>MPC Drive2 Last Fault Code</b> Provides the latest fault code of drive 2 while using the multi-pump mode.	2, 3, 4	RO
2245	P18.3.1.3	<b>MPC Drive3 Last Fault Code</b> Provides the latest fault code of drive 3 while using the multi-pump mode.	2, 3, 4	RO
2257	P18.3.1.4	<b>MPC Drive4 Last Fault Code</b> Provides the latest fault code of drive 4 while using the multi-pump mode.	2, 3, 4	RO
2269	P18.3.1.5	<b>MPC Drive5 Last Fault Code</b> Provides the latest fault code of drive 5 while using the multi-pump mode.	2, 3, 4	RO
2222	P18.3.2.1	<b>MPC Drive1 F-Out</b> Provides the output frequency (Hz) of drive 1 while using the multi-pump mode.	2, 3, 4	RO
2234	P18.3.2.2	<b>MPC Drive2 F-Out</b> Provides the output frequency (Hz) of drive 2 while using the multi-pump mode.	2, 3, 4	RO
2246	P18.3.2.3	<b>MPC Drive3 F-Out</b> Provides the output frequency (Hz) of drive 3 while using the multi-pump mode.	2, 3, 4	RO
2258	P18.3.2.4	<b>MPC Drive4 F-Out</b> Provides the output frequency (Hz) of drive 4 while using the multi-pump mode.	2, 3, 4	RO
2270	P18.3.2.5	<b>MPC Drive5 F-Out</b> Provides the output frequency (Hz) of drive 5 while using the multi-pump mode.	2, 3, 4	RO
2223	P18.3.3.1	<b>MPC Drive1 V-Out</b> Provides the motor voltage (Vac) of drive 1 while using the multi-pump mode.	2, 3, 4	RO
2235	P18.3.3.2	<b>MPC Drive2 V-Out</b> Provides the motor voltage (Vac) of drive 2 while using the multi-pump mode.	2, 3, 4	RO
2247	P18.3.3.3	<b>MPC Drive3 V-Out</b> Provides the motor voltage (Vac) of drive 3 while using the multi-pump mode.	2, 3, 4	RO
2259	P18.3.3.4	<b>MPC Drive4 V-Out</b> Provides the motor voltage (Vac) of drive 4 while using the multi-pump mode.	2, 3, 4	RO
2271	P18.3.3.5	<b>MPC Drive5 V-Out</b> Provides the motor voltage (Vac) of drive 5 while using the multi-pump mode.	2, 3, 4	RO

Modbus ID	Code	Parameters	Application	RO/RW
2224	P18.3.4.1	<b>MPC Drive1 I-Out</b> Provides the motor current (Amps) of drive 1 while using the multi-pump mode.	2, 3, 4	RO
2236	P18.3.4.2	<b>MPC Drive2 I-Out</b> Provides the motor current (Amps) of drive 2 while using the multi-pump mode.	2, 3, 4	RO
2248	P18.3.4.3	<b>MPC Drive3 I-Out</b> Provides the motor current (Amps) of drive 3 while using the multi-pump mode.	2, 3, 4	RO
2260	P18.3.4.4	<b>MPC Drive4 I-Out</b> Provides the motor current (Amps) of drive 4 while using the multi-pump mode.	2, 3, 4	RO
2272	P18.3.4.5	<b>MPC Drive5 I-Out</b> Provides the motor current (Amps) of drive 5 while using the multi-pump mode.	2, 3, 4	RO
2225	P18.3.5.1	<b>MPC Drive1 M-Out</b> Provides the motor torque (%) of drive 1 while using the multi-pump mode.	2, 3, 4	RO
2237	P18.3.5.2	<b>MPC Drive2 M-Out</b> Provides the motor torque (%) of drive 2 while using the multi-pump mode.	2, 3, 4	RO
2249	P18.3.5.3	<b>MPC Drive3 M-Out</b> Provides the motor torque (%) of drive 3 while using the multi-pump mode.	2, 3, 4	RO
2261	P18.3.5.4	<b>MPC Drive4 M-Out</b> Provides the motor torque (%) of drive 4 while using the multi-pump mode.	2, 3, 4	RO
2273	P18.3.5.5	<b>MPC Drive5 M-Out</b> Provides the motor torque (%) of drive 5 while using the multi-pump mode.	2, 3, 4	RO
2226	P18.3.6.1	<b>MPC Drive1 P-Out</b> Provides the motor power (%) of drive 1 while using the multi-pump mode.	2, 3, 4	RO
2238	P18.3.6.2	<b>MPC Drive2 P-Out</b> Provides the motor power (%) of drive 2 while using the multi-pump mode.	2, 3, 4	RO
2250	P18.3.6.3	<b>MPC Drive3 P-Out</b> Provides the motor power (%) of drive 3 while using the multi-pump mode.	2, 3, 4	RO
2262	P18.3.6.4	<b>MPC Drive4 P-Out</b> Provides the motor power (%) of drive 4 while using the multi-pump mode.	2, 3, 4	RO
2274	P18.3.6.5	<b>MPC Drive5 P-Out</b> Provides the motor power (%) of drive 5 while using the multi-pump mode.	2, 3, 4	RO
2227	P18.3.7.1	<b>MPC Drive1 N-Out</b> Provides the motor speed (RPM) of drive 1 while using the multi-pump mode.	2, 3, 4	RO
2239	P18.3.7.2	<b>MPC Drive2 N-Out</b> Provides the motor speed (RPM) of drive 2 while using the multi-pump mode.	2, 3, 4	RO
2251	P18.3.7.3	<b>MPC Drive3 N-Out</b> Provides the motor speed (RPM) of drive 3 while using the multi-pump mode.	2, 3, 4	RO
2263	P18.3.7.4	<b>MPC Drive4 N-Out</b> Provides the motor speed (RPM) of drive 4 while using the multi-pump mode.	2, 3, 4	RO
2275	P18.3.7.5	<b>MPC Drive5 N-Out</b> Provides the motor speed (RPM) of drive 5 while using the multi-pump mode.	2, 3, 4	RO
2228	P18.3.8.1	<b>MPC Drive1 T-Run</b> Provides the motor run time of drive 1 while using the multi-pump mode.	2, 3, 4	RO
2240	P18.3.8.2	<b>MPC Drive2 T-Run</b> Provides the motor run time of drive 2 while using the multi-pump mode.	2, 3, 4	RO
2252	P18.3.8.3	<b>MPC Drive3 T-Run</b> Provides the motor run time of drive 3 while using the multi-pump mode.	2, 3, 4	RO
2264	P18.3.8.4	<b>MPC Drive4 T-Run</b> Provides the motor run time of drive 4 while using the multi-pump mode.	2, 3, 4	RO
2276	P18.3.8.5	<b>MPC Drive5 T-Run</b> Provides the motor run time of drive 5 while using the multi-pump mode.	2, 3, 4	RO
342	P18.4.1	<b>Number of Pumps</b> Total number of auxiliary motors/pumps to be used with the multi-pump system. When in single drive mode, this functions as the amount of motors on a single drive. When in multi drive mode, this functions as the most drives active at one time.	2, 3, 4	RW

## Appendix A—Description of parameters

Modbus ID	Code	Parameters	Application	RO/RW
346	P18.4.2	<b>Include Freq Converter</b> When enable this tells the drive if the motor/pump connected to frequency converter is included in the auto change sequence when using auxiliary contacts. Not available in multi-drive mode.	2, 3, 4	RW
345	P18.4.3	<b>Auto-Change Enable</b> Auto-change will rotate the starting order/priority of the motors in the system to get equal run time on all the motors. Not available in multi-drive mode.	2, 3, 4	RW
347	P18.4.4	<b>Auto-Change Interval</b> Defines how often to rotate starting order of motors/pumps. Not available in multi-drive mode.	2, 3, 4	RW
349	P18.4.5	<b>Auto-Change Freq Limit</b> An auto-change is done when the auto-change interval has elapsed and the drive is running below auto-change frequency limit. Not available in multi-drive mode.	2, 3, 4	RW
348	P18.4.6	<b>Auto-Change Pump Limit</b> An auto-change is done when the auto-change interval has elapsed and the number of running aux. motors is less than auto-change motor limit. Not available in multi-drive mode.	2, 3, 4	RW
2439	P18.4.7	<b>Pipe Fill Aux Pump Select</b> Pipe fill aux. pump select.	2, 3, 4	RW
2440	P18.4.8	<b>Pipe Fill Aux Pump Run Time</b> Pipe fill aux. pump run time.	2, 3, 4	RW
2441	P18.4.9	<b>Pipe Fill Aux Pump Operation</b> Pipe fill aux. pump operation.	2, 3, 4	RW
2442	P18.4.10	<b>Pipe Fill Aux Pump Delay</b> Pipe fill aux. pump delay.	2, 3, 4	RW
2449	P18.5.1	<b>Number of Drives</b> This defines the number of drives active when doing the multi-drive pump and fan scheme. By default, there will be always 1 drive active at 1 time by setting value to above 1 it allows to bring in additional drives to maintain the system.	2, 3, 4	RW
2284	P18.5.2	<b>Regulation Source</b> Drives that have been connected with both start/stop signal and PID feedback can be set up as "Feedback", so they will have ability to be master. 0 = Network only. 1 = PID controller.	2, 3, 4	RW
2285	P18.5.3	<b>Recovery Method</b> This parameter is for the slave when multi-drive system lost master. Slave drive can continue run if it set to be "Automatic", however slave drive will stop immediately if it is set to be "Stop". 0 = Automatic. 1 = Stop.	2, 3, 4	RW
2286	P18.5.4	<b>Callback Source</b> Sometimes some information needs to be callback from slave to master and affect whole system. If slave drive has a callback source as STO, when it suffers STO fault, master drive will answer this callback and shutdown whole system. 0 = No action. 1 = Safety torque off.	2, 3, 4	RW
2311	P18.5.5	<b>Add/Remove Drive Selection</b> In default, MPFC system will add/remove pump according to their drive ID, from small to large; and the order can also depend on each slave drive's running time: add the drive has shortest running time and remove the drive has longest running time first. 0 = Drive ID. 1 = Run time.	2, 3, 4	RW
2280	P18.5.6	<b>Run Time Enable</b> The run time counter will start counting only if this parameter is enabled. 0 = Disable. 1 = Enable.	2, 3, 4	RW
2281	P18.5.7	<b>Run Time Limit</b> If drive run time is over this limit, its network status will be "Need Alternation". Limit equals 0 means run time counter disabled.	2, 3, 4	RW

Modbus ID	Code	Parameters	Application	RO/RW
2283	P18.5.8	<b>Run Time Reset</b> One-time parameter, set to be 1 will clear run time counter. 0 = No action 1 = Reset.	2, 3, 4	RW
2473	P18.5.9	<b>Master Drive Mode</b> Defines how the master drive will maintain the frequency control when slaves are brought in; follow PI, fixed speed, or turn itself off. 0 = Follow PID 1 = Fixed speed 2 = Turn off.	2, 3, 4	RW
2474	P18.5.10	<b>Master Fixed Speed</b> Defines the fixed speed frequency when the master drive mode is set for fixed speed control when slaves are brought in.	2, 3, 4	RW
2475	P18.5.11	<b>Master Fixed Speed Delay</b> Defines the delay time before the master drive begins running at the fixed speed or turns off if the master mode is set for fixed speed or turn off.	2, 3, 4	RW
2406	P18.6.1	<b>Pipe Fill Loss Detection Method</b> Defines the value for looking at a loss of prime. 0 = Motor current. 1 = Motor power (%). 2 = Motor torque (%).	2, 3, 4	RW
2407	P18.6.2	<b>Pipe Fill Loss Level</b> Selects the level at which to look at a condition of loss of prime. When the measured value defined in the detection method drops below this level for the prime loss time and is above the prime loss frequency level, the drive will respond based off parameter pipe fill loss response.	2, 3, 4	RW
2408	P18.6.3	<b>Pipe Fill Loss Time</b> Defines the delay time before a "Loss of Prime" condition will occur based of the detection method and prime loss level.	2, 3, 4	RW
2409	P18.6.4	<b>Pipe Fill Loss Frequency</b> Defines the frequency point at which the drive needs to be above to enabled the "Loss of Prime" feature. When set to 0 Hz, protection is disabled.	2, 3, 4	RW
2410	P18.6.5	<b>Pipe Fill Loss Response</b> Defines the response method when a "Loss of Prime" condition occurs. 0 = No action 1 = Warning, No sStore 2 = Warning, Store.	2, 3, 4	RW
2411	P18.6.6	<b>Pipe Fill Loss Attempts</b> Defines the amount of temps to auto-restart the drive on an "Prime Loss" condition.	2, 3, 4	RW
2428	P18.6.7	<b>Prime Pump Enable</b> This will enable or disabled the pre-charge function to allow for pre-filling a system before going into PID control mode. See Par ID 190.	2, 3, 4	RW
2429	P18.6.8	<b>Prime Pump Level</b> This defines the level at which the pre-charge function will drop out. If the feedback level rise above this value, pre-charge becomes deactivated. If the level is not reached, it will switch after the delay time.	2, 3, 4	RW
2431	P18.6.9	<b>Prime Pump Frequency</b> Frequency at which the pre-charge function will operate when enabled.	2, 3, 4	RW
2432	P18.6.10	<b>Prime Pump Delay Time</b> This is the time that the drive will run the pre-charge function on start up. When set to 0 Hz, this function is not enabled. When set to 0 Hz, this function is not enabled.	2, 3, 4	RW
2433	P18.6.11	<b>Prime Pump Loss of Prime Level</b> Selects the limit to indicate a loss of prime in pump. If the measured current drops below the determined value for the value assigned in the prime loss of time setting, the drive will display a pre-charge loss of prime.	2, 3, 4	RW

## Appendix A—Description of parameters

Modbus ID	Code	Parameters	Application	RO/RW
2434	P18.6.12	<b>Prime Pump Level 2</b> This defines the level at which the pre-charge function will drop out. If the feedback level rises above this value, pre-charge becomes deactivated. If the level is not reached, it will switch after the delay time.	2, 3, 4	RW
2436	P18.6.13	<b>Prime Pump Frequency 2</b> Frequency at which the pre-charge level 2 will operate at when enabled.	2, 3, 4	RW
2437	P18.6.14	<b>Prime Pump Delay Time 2</b> This is the time that the drive will run at the 2nd level pre-charge function level. When set to 0 Hz, this function is not enabled.	2, 3, 4	RW
2438	P18.6.15	<b>Prime Pump Loss of Prime Level 2</b> Selects the limit to indicate a loss of prime in pump. If the measured current drops below the determined value for the value assigned in the prime loss of time setting, the drive will display a pre-charge loss of prime.	2, 3, 4	RW
1853	P18.6.16	<b>Broken Pipe Fault Response</b> Broken pipe fault response. 0 = No action 1 = Warning 2 = Fault 3 = Fault, Coast.	2, 3, 4	RW
1854	P18.6.17	<b>Broken Pipe Level</b> Broken pipe level.	2, 3, 4	RW
1855	P18.6.18	<b>Broken Pipe Delay</b> Broken pipe delay.	2, 3, 4	RW
1856	P18.6.19	<b>Broken Pipe Frequency</b> Broken pipe frequency.	2, 3, 4	RW
2804	P18.6.20	<b>Jockey Pump Enable</b> Jockey pump enable. 0 = Not used 1 = PID sleep 2 = PID sleep (Level).	2, 3, 4	RW
2805	P18.6.21	<b>Jockey Start Level</b> Jockey start level.	2, 3, 4	RW
2807	P18.6.22	<b>Jockey Stop Level</b> Jockey stop level.	2, 3, 4	RW
2809	P18.6.23	<b>Lube Pump Enable</b> Lube pump enable. 0 = Disabled 1 = Enabled.	2, 3, 4	RW
2810	P18.6.24	<b>Lube Pump Time</b> Lube pump time.	2, 3, 4	RW
491	P19.1	<b>Interval 1 On Time</b> On time for interval function. It uses 24-hour format. Use to specify a time of day for a desired function to be disabled.	2, 3, 4	RW
493	P19.2	<b>Interval 1 Off Time</b> Off time for interval function. It uses 24-hour format. Use to specify a time of day for a desired function to be disabled.	2, 3, 4	RW



<b>Modbus ID</b>	<b>Code</b>	<b>Parameters</b>	<b>Application</b>	<b>RO/RW</b>
517	P19.3	<b>Interval 1 From Day</b> On day of week for interval function. 0 = Sunday 1 = Monday 2 = Tuesday 3 = Wednesday 4 = Thursday 5 = Friday 6 = Saturday	2, 3, 4	RW
518	P19.4	<b>Interval 1 To Day</b> On day of week for interval function. 0 = Sunday 1 = Monday 2 = Tuesday 3 = Wednesday 4 = Thursday 5 = Friday 6 = Saturday	2, 3, 4	RW
519	P19.5	<b>Interval 1 Channel</b> Select affected time channel to store the interval time. 0 = Not used. 1 = Time channel 1. 2 = Time channel 2. 3 = Time channel 3.	2, 3, 4	RW
495	P19.6	<b>Interval 2 On Time</b> On time for interval function. It uses 24-hour format. Use to specify a time of day for a desired function to be disabled.	2, 3, 4	RW
497	P19.7	<b>Interval 2 Off Time</b> Off time for interval function. It uses 24-hour format. Use to specify a time of day for a desired function to be disabled.	2, 3, 4	RW
520	P19.8	<b>Interval 2 From Day</b> On day of week for interval function. See Par ID 517.	2, 3, 4	RW
521	P19.9	<b>Interval 2 To Day</b> On day of week for interval function. See Par ID 517.	2, 3, 4	RW
522	P19.10	<b>Interval 2 Channel</b> Select affected time channel to store the interval time. See Par ID 519.	2, 3, 4	RW
499	P19.11	<b>Interval 3 On Time</b> On time for interval function. It uses 24-hour format. Use to specify a time of day for a desired function to be disabled.	2, 3, 4	RW
501	P19.12	<b>Interval 3 Off Time</b> Off time for interval function. It uses 24-hour format. Use to specify a time of day for a desired function to be disabled.	2, 3, 4	RW
523	P19.13	<b>Interval 3 From Day</b> On day of week for interval function. See Par ID 517.	2, 3, 4	RW
524	P19.14	<b>Interval 3 To Day</b> On day of week for interval function. See Par ID 517.	2, 3, 4	RW
525	P19.15	<b>Interval 3 Channel</b> Select affected time channel to store the interval time. See Par ID 519.	2, 3, 4	RW

## Appendix A—Description of parameters

Modbus ID	Code	Parameters	Application	RO/RW
503	P19.16	<b>Interval 4 On Time</b> On time for interval function. It uses 24-hour format. Use to specify a time of day for a desired function to be disabled.	2, 3, 4	RW
505	P19.17	<b>Interval 4 Off Time</b> Off time for interval function. It uses 24-hour format. Use to specify a time of day for a desired function to be disabled.	2, 3, 4	RW
526	P19.18	<b>Interval 4 From Day</b> On day of week for interval function. See Par ID 517.	2, 3, 4	RW
527	P19.19	<b>Interval 4 To Day</b> On day of week for interval function. See Par ID 517.	2, 3, 4	RW
528	P19.20	<b>Interval 4 Channel</b> Select affected time channel to store the interval time. See Par ID 519.	2, 3, 4	RW
507	P19.21	<b>Interval 5 On Time</b> On time for interval function. It uses 24-hour format. Use to specify a time of day for a desired function to be disabled.	2, 3, 4	RW
509	P19.22	<b>Interval 5 Off Time</b> Off time for interval function. It uses 24-hour format. Use to specify a time of day for a desired function to be disabled.	2, 3, 4	RW
529	P19.23	<b>Interval 5 From Day</b> On day of week for interval function. See Par ID 517.	2, 3, 4	RW
530	P19.24	<b>Interval 5 To Day</b> On day of week for interval function. See Par ID 517.	2, 3, 4	RW
531	P19.25	<b>Interval 5 Channel</b> Select affected time channel to store the interval time. See Par ID 519.	2, 3, 4	RW
511	P19.26	<b>Timer 1 Duration</b> The timer will run when activated (activated by DI).	2, 3, 4	RW
532	P19.27	<b>Timer 1 Channel</b> Select affected time channel. 0 = Not used. 1 = Time channel 1. 2 = Time channel 2. 3 = Time channel 3.	2, 3, 4	RW
513	P19.28	<b>Timer 2 Duration</b> The timer will run when activated (activated by DI).	2, 3, 4	RW
533	P19.29	<b>Timer 2 Channel</b> Select affected time channel. See Par ID 532.	2, 3, 4	RW
515	P19.30	<b>Timer 3 Duration</b> The timer will run when activated (activated by DI).	2, 3, 4	RW
534	P19.31	<b>Timer 3 Channel</b> Select affected time channel. See Par ID 532.	2, 3, 4	RW
2487	P19.32	<b>Interval 1 Setting</b> Defines the interval time setting for interval 1; to be weekly or daily. 0 = Weekly - Would setup the timer for the week long. 1 = Daily - Would setup the timer for the defined day.	2, 3, 4	RW

<b>Modbus ID</b>	<b>Code</b>	<b>Parameters</b>	<b>Application</b>	<b>RO/RW</b>
2488	P19.33	<b>Interval 2 Setting</b> Defines the interval time setting for interval 1; to be weekly or daily. See Par ID 2487.	2, 3, 4	RW
2489	P19.34	<b>Interval 3 Setting</b> Defines the interval time setting for interval 1; to be weekly or daily. See Par ID 2487.	2, 3, 4	RW
2490	P19.35	<b>Interval 4 Setting</b> Defines the interval time setting for interval 1; to be weekly or daily. See Par ID 2487.	2, 3, 4	RW
2491	P19.36	<b>Interval 5 Setting</b> Defines the interval time setting for interval 1; to be weekly or daily. See Par ID 2487.	2, 3, 4	RW
2533	P20.1.1	<b>FB Process Data Input 1 Sel</b> With the Fieldbus data output selections, parameter/monitor IDs can be assigned to these registers and then read over the desired Fieldbus network word for process data. Any drive parameter with an ID can be read over these values. Default values for process data out in Fieldbus (build table for below values). Process Data Out1 - Output Frequency = ID 1. Process Data Out2 - Motor Speed = ID 2. Process Data Out3 - Motor Current = ID 3. Process Data Out4 - Motor Torque = ID 4. Process Data Out5 - Motor Power = ID 5. Process Data Out6 - Motor Voltage = ID 6. Process Data Out7 - DC Link Voltage = ID 7. Process Data Out8 - Active Fault Code = ID 28. See Communication Manual MN040010EN for more details.	1, 2, 3, 4	RW
2534	P20.1.2	<b>FB Process Data Input 2 Sel</b> With the Fieldbus data output selections, parameter/monitor IDs can be assigned to these registers and then read over the desired Fieldbus network word for process data. Any drive parameter with an ID can be read over these values. Default values for process data Out in Fieldbus. See Par ID 2533.	1, 2, 3, 4	RW
2535	P20.1.3	<b>FB Process Data Input 3 Sel</b> With the Fieldbus data output selections, parameter/monitor IDs can be assigned to these registers and then read over the desired Fieldbus network word for process data. Any drive parameter with an ID can be read over these values. Default values for process data out in Fieldbus. See Par ID 2533.	1, 2, 3, 4	RW
2536	P20.1.4	<b>FB Process Data Input 4 Sel</b> With the Fieldbus data output selections, parameter/monitor IDs can be assigned to these registers and then read over the desired Fieldbus network word for process data. Any drive parameter with an ID can be read over these values. Default values for process data Out in Fieldbus. See Par ID 2533.	1, 2, 3, 4	RW
2537	P20.1.5	<b>FB Process Data Input 5 Sel</b> With the Fieldbus data output selections, parameter/monitor IDs can be assigned to these registers and then read over the desired Fieldbus network word for process data. Any drive parameter with an ID can be read over these values. Default values for process data out in Fieldbus. See Par ID 2533.	1, 2, 3, 4	RW

## Appendix A—Description of parameters

<b>Modbus ID</b>	<b>Code</b>	<b>Parameters</b>	<b>Application</b>	<b>RO/RW</b>
2538	P20.1.6	<p><b>FB Process Data Input 6 Sel</b></p> <p>With the Fieldbus data output selections, parameter/monitor ids can be assigned to these registers and then read over the desired Fieldbus network word for process data. Any drive parameter with an ID can be read over these values.</p> <p>Default values for process data out in Fieldbus.</p> <p>See Par ID 2533.</p>	1, 2, 3, 4	RW
2539	P20.1.7	<p><b>FB Process Data Input 7 Sel</b></p> <p>With the Fieldbus data output selections, parameter/monitor ids can be assigned to these registers and then read over the desired Fieldbus network word for process data. Any drive parameter with an ID can be read over these values.</p> <p>Default values for process data out in Fieldbus.</p> <p>See Par ID 2533.</p>	1, 2, 3, 4	RW
2540	P20.1.8	<p><b>FB Process Data Input 8 Sel</b></p> <p>With the Fieldbus data output selections, parameter/monitor ids can be assigned to these registers and then read over the desired Fieldbus network word for process data. Any drive parameter with an ID can be read over these values.</p> <p>Default values for process data out in Fieldbus.</p> <p>See Par ID 2533.</p>	1, 2, 3, 4	RW
1556	P20.2.1	<p><b>FB Process Data Output 1 Sel</b></p> <p>With the Fieldbus data output selections, parameter/monitor ids can be assigned to these registers and then read over the desired Fieldbus network word for process data. Any drive parameter with an ID can be read over these values.</p> <p>Default values for process data out in Fieldbus.</p> <p>See Par ID 2533.</p>	1, 2, 3, 4	RW
1557	P20.2.2	<p><b>FB Process Data Output 2 Sel</b></p> <p>With the Fieldbus data output selections, parameter/monitor ids can be assigned to these registers and then read over the desired Fieldbus network word for process data. Any drive parameter with an ID can be read over these values.</p> <p>Default values for process data out in Fieldbus.</p> <p>See Par ID 2533.</p>	1, 2, 3, 4	RW

<b>Modbus ID</b>	<b>Code</b>	<b>Parameters</b>	<b>Application</b>	<b>RO/RW</b>
1558	P20.2.3	<p><b>FB Process Data Output 3 Sel</b></p> <p>With the Fieldbus data output selections, parameter/monitor ids can be assigned to these registers and then read over the desired Fieldbus network word for process data. Any drive parameter with an ID can be read over these values.</p> <p>Default values for process data Out in Fieldbus.</p> <p>See Par ID 2533.</p>	1, 2, 3, 4	RW
1559	P20.2.4	<p><b>FB Process Data Output 4 Sel</b></p> <p>With the Fieldbus data output selections, parameter/monitor ids can be assigned to these registers and then read over the desired Fieldbus network word for process data. Any drive parameter with an ID can be read over these values.</p> <p>Default values for process data out in Fieldbus.</p> <p>See Par ID 2533.</p>	1, 2, 3, 4	RW
1560	P20.2.5	<p><b>FB Process Data Output 5 Sel</b></p> <p>With the Fieldbus data output selections, parameter/monitor ids can be assigned to these registers and then read over the desired Fieldbus network word for process data. Any drive parameter with an ID can be read over these values.</p> <p>Default values for process data out in Fieldbus.</p> <p>See Par ID 2533.</p>	1, 2, 3, 4	RW
1561	P20.2.6	<p><b>FB Process Data Output 6 Sel</b></p> <p>With the Fieldbus data output selections, parameter/monitor ids can be assigned to these registers and then read over the desired Fieldbus network word for process data. Any drive parameter with an ID can be read over these values.</p> <p>Default values for process data out in Fieldbus.</p> <p>See Par ID 2533.</p>	1, 2, 3, 4	RW
1562	P20.2.7	<p><b>FB Process Data Output 7 Sel</b></p> <p>With the Fieldbus data output selections, parameter/monitor ids can be assigned to these registers and then read over the desired Fieldbus network word for process data. Any drive parameter with an ID can be read over these values.</p> <p>Default values for process data out in Fieldbus.</p> <p>See Par ID 2533.</p>	1, 2, 3, 4	RW
1563	P20.2.8	<p><b>FB Process Data Output 8 Sel</b></p> <p>With the Fieldbus data output selections, parameter/monitor ids can be assigned to these registers and then read over the desired Fieldbus network word for process data. Any drive parameter with an ID can be read over these values.</p> <p>Default values for process data out in Fieldbus.</p> <p>See Par ID 2533.</p>	1, 2, 3, 4	RW

## Appendix A—Description of parameters

Modbus ID	Code	Parameters	Application	RO/RW
2415	P20.2.9	<p><b>Standard Status Word Bit0 Function Selec</b></p> <p>This parameter allows for setting one of the DO/RO functions to a status word that then can be read over the communication standard status word. This also can be viewed in the keypad monitor value M50.</p> <p>0 = Not Used            1 = Ready            2 = Run            3 = Fault            4 = Fault invert            5 = Warning            6 = Reversed            7 = At speed            8 = Zero frequency            9 = Freq limit 1 Superv            10 = Freq limit 2 Superv            11 = PID1 Superv            12 = PID2 Superv            13 = Over-heat fault            14 = Over-current regular            15 = Over-voltage regular            16 = Under-voltage regular            17 = 4 mA Ref fault/warning            18 = Ext brake control            19 = Ext brake inverted            20 = Torq limit Superv            21 = Ref limit Superv            22 = Control from I/O            23 = Un-requested rotation direction            24 = Thermistor fault output            25 = Fire mode            26 = In bypass mode            27 = Ext fault/warning            28 = Remote control            29 = Jog speed select            30 = Motor therm. protection            31 = FB digital Input 1            32 = FB digital Input 2            33 = FB digital Input 3</p>	1, 2, 3, 4	RW

Modbus ID	Code	Parameters	Application	RO/RW
2415	P20.2.9	<b>Standard Status Word Bit0 Function Select, continued</b>	1, 2, 3, 4	RW
		34 = FB digital Input 4 35 = Damper control 36 = TC1 status 37 = TC2 status 38 = TC3 status 39 = In E-stop 40 = Power limit Superv 41 = Temp limit Superv 42 = Analog input Superv 43 = Motor 1 control 44 = Motor 2 control 45 = Motor 3 control 46 = Motor 4 control 47 = Motor 5 control 48 = Logic fulfilled 49 = PID1 sleep 50 = PID2 sleep 51 = Motor current 1 Supv 52 = Motor current 2 Supv 53 = Second AI limit Supv 54 = DC charge switch close 55 = Preheat active 56 = Cold weather active 57 = Prime pump active 58 = 2nd stage ramp frequency active 59 = STO fault output 60 = Run bypass/drive 61 = Bypass overload 62 = Bypass run 63 = Auto local on COM fault 64 = Fieldbus RTU fault 65 = Fieldbus TCP fault 66 = Fieldbus MSTP fault 67 = Fieldbus EIP fault 68 = Fieldbus SlotA fault 69 = Fieldbus SlotB fault 70 = Fieldbus SWD fault 71 = Jockey pump active 72 = Lube pump active 73 = PID1 low feedback 74 = PID1 high feedback 75 = PID2 low feedback 76 = PID2 high feedback 77 = Master in MPFC 78 = CP interlock fault.		
2416	P20.2.10	<b>Standard Status Word Bit1 Function Select</b> This parameter allows for setting one of the DO/RO functions to a status word that then can be read over the communication standard status word. This also can be viewed in the keypad monitor value M50. See Par ID 2415	1, 2, 3, 4	RW

## Appendix A—Description of parameters

Modbus ID	Code	Parameters	Application	RO/RW
2417	P20.2.11	<p><b>Standard Status Word Bit2 Function Select</b></p> <p>This parameter allows for setting one of the DO/RO functions to a status word that then can be read over the communication standard status word. This also can be viewed in the keypad monitor value M50.</p> <p>See Par ID 2415</p>	1, 2, 3, 4	RW
2418	P20.2.12	<p><b>Standard Status Word Bit3 Function Select</b></p> <p>This parameter allows for setting one of the DO/RO functions to a status word that then can be read over the communication standard status word. This also can be viewed in the keypad monitor value M50.</p> <p>See Par ID 2415</p>	1, 2, 3, 4	RW
2419	P20.2.13	<p><b>Standard Status Word Bit4 Function Select</b></p> <p>This parameter allows for setting one of the DO/RO functions to a status word that then can be read over the communication standard status word. This also can be viewed in the keypad monitor value M50.</p> <p>See Par ID 2415</p>	1, 2, 3, 4	RW
2420	P20.2.14	<p><b>Standard Status Word Bit5 Function Select</b></p> <p>This parameter allows for setting one of the DO/RO functions to a status word that then can be read over the communication standard status word. This also can be viewed in the keypad monitor value M50.</p> <p>See Par ID 2415</p>	1, 2, 3, 4	RW
2421	P20.2.15	<p><b>Standard Status Word Bit6 Function Select</b></p> <p>This parameter allows for setting one of the DO/RO functions to a status word that then can be read over the communication standard status word. This also can be viewed in the keypad monitor value M50.</p> <p>See Par ID 2415</p>	1, 2, 3, 4	RW
2422	P20.2.16	<p><b>Standard Status Word Bit7 Function Select</b></p> <p>This parameter allows for setting one of the DO/RO functions to a status word that then can be read over the communication standard status word. This also can be viewed in the keypad monitor value M50.</p> <p>See Par ID 2415</p>	1, 2, 3, 4	RW
586	P20.3.1.1	<p><b>RS485 Comm Set</b></p> <p>This parameter defines the communication protocol for RS-485.</p> <p>0 = Modbus RTU.</p> <p>1 = BACnet MS/TP.</p>	1, 2, 3, 4	RW
587	P20.3.2.1	<p><b>Slave Address</b></p> <p>This parameter defines the slave address for RS-485 communication.</p>	1, 2, 3, 4	RW
584	P20.3.2.2	<p><b>Baud Rate</b></p> <p>This parameter defines communication speed for RS-485 communication.</p> <p>0 = 9600</p> <p>1 = 19200</p> <p>2 = 38400</p> <p>3 = 57600</p> <p>4 = 115200.</p>	1, 2, 3, 4	RW
585	P20.3.2.3	<p><b>Parity Type And Stop Bit</b></p> <p>This parameter defines parity type for RS-485 communication.</p> <p>0 = None and 2 stop bits</p> <p>1 = Odd and 1 stop bit</p> <p>2 = Even and 1 stop bit</p> <p>3 = None and 1 stop bit.</p>	1, 2, 3, 4	RW
588	P20.3.2.4	<p><b>Modbus RTU Protocol Status</b></p> <p>This parameter shows the protocol status for RS-485 communication.</p> <p>0 = Initial.</p> <p>1 = Stopped.</p> <p>2 = Operational.</p> <p>3 = Faulted.</p>	1, 2, 3, 4	RO



<b>Modbus ID</b>	<b>Code</b>	<b>Parameters</b>	<b>Application</b>	<b>RO/RW</b>
593	P20.3.2.5	<b>Comm Timeout Modbus RTU</b> Selects the time to wait before a communication fault occurs over Modbus RTU if a message is not received.	1, 2, 3, 4	RW
2516	P20.3.2.6	<b>Modbus RTU Fault Response</b> Defines the Fieldbus fault condition for Modbus RTU communication. 0 = Only in Fieldbus control mode - When Fieldbus is the control place and Fieldbus fault is active drive will fault on loss of coms., if not in Fieldbus control place will not fault. 1 = In all control modes - No matter the control place setting if communication is lost Fieldbus fault response will occur.	1, 2, 3, 4	RW
594	P20.3.3.1	<b>MSTP Baud Rate</b> This parameter defines communication speed for RS-485 communication.	1, 2, 3, 4	RW
595	P20.3.3.2	<b>MSTP Device Address</b> Defines the device address of the drive on the Bacnet MSTP network.	1, 2, 3, 4	RW
596	P20.3.3.3	<b>MSTP Instance Number</b> Defines the instance number of the drive on the Bacnet MSTP network.	1, 2, 3, 4	RW
598	P20.3.3.4	<b>MSTP Comm Timeout</b> Selects the time to wait before a communication fault occurs over Bacnet MSTP if a message is not received.	1, 2, 3, 4	RW
599	P20.3.3.5	<b>MSTP Protocol Status</b> This parameter shows the protocol status for Bacnet MSTP communication. 0 = Stopped. 1 = Operational. 2 = Faulted.	1, 2, 3, 4	RO
600	P20.3.3.6	<b>MSTP Fault Code</b> This parameter shows the protocol status for Bacnet MSTP communication. 0 = None. 1 = Sole master. 2 = Duplicate MAC ID. 3 = Baud rate fault.	1, 2, 3, 4	RO
2526	P20.3.3.7	<b>MSTP Fault Response</b> Defines the Fieldbus fault condition for Bacnet MSTP communication. 0 = Only in Fieldbus control mode - When Fieldbus is the control place and Fieldbus fault is active drive will fault on loss of communications, if not in Fieldbus control place will not fault. 1 = In all control modes - No matter the control place setting if communication is lost Fieldbus fault response will occur.	1, 2, 3, 4	RW
1537	P20.3.3.8	<b>MSTP Max Master</b> MSTP Max Master.	1, 2, 3, 4	RW
2630	P20.3.4.1	<b>Parameter Access</b> PNU927 which specifies the operation priority of parameters for Acyclic communication: 0 = No permission to read/write on Acyclic channel. 1 = Acyclic read/write are allowed on ProfiBus.	1, 2, 3, 4	RW
2631	P20.3.4.2	<b>Process Data Access</b> PNU928 which specifies the control priority of the device for Cyclic communication: 0 = Local control. 1 = Fieldbus. 2 = Mixed interface. 4 = Local on fault. 5 = Dual mode.	1, 2, 3, 4	RW
2632	P20.3.4.3	<b>Fault Situation Counter</b> PNU952 which specifies the Fault situation counter. Only write of 0 is allowed, then whole fault buffer (actual fault situation and all other fault situations) and the fault message counter (parameter 944) are erased.	1, 2, 3, 4	RW

## Appendix A—Description of parameters

Modbus ID	Code	Parameters	Application	RO/RW
2609	P20.3.4.4	<b>Board Status</b> Status of the board: B0 = DCOM comm. fault. B1 = Board HW fault. B2 = IO1 24 volt overload fault. B3 = Profibus comm. fault. B4 = Fieldbus fault.	1, 2, 3, 4	RO
2610	P20.3.4.5	<b>Firmware Version</b> This parameter provides the firmware version of the SWD.	1, 2, 3, 4	RO
2612	P20.3.4.6	<b>Protocol Status</b> This parameter specifies the protocol status for SWD card: 0 = Not configured. 1 = Operational. 2 = Diagnostics.	1, 2, 3, 4	RO
2613	P20.3.4.7	<b>Operation Mode</b> This parameter specifies the operation mode of SWD card. 0 = PD2x16Bit Profil. 1 = 8 Bit Profil. 2 = 1-0-A switch.	1, 2, 3, 4	RO
2614	P20.3.4.8	<b>PDP-Telegram Selection</b> PNU922 which specifies the telegram selection for application class.	1, 2, 3, 4	RO
2615	P20.3.4.9	<b>Fault Counter PDP</b> PNU944 which specifies the fault message counter in fault buffer.	1, 2, 3, 4	RO
2616	P20.3.4.10	<b>Fault Situations Max</b> PNU950 which specifies the scaling of the fault buffer.	1, 2, 3, 4	RO
2618	P20.3.4.11	<b>PDP-Profil Number</b> PNU965 which specifies the profile and version.	1, 2, 3, 4	RO
2619	P20.3.4.12	<b>PDP-Control Word</b> PNU967 which specifies the control word received from PLC.	1, 2, 3, 4	RO
2620	P20.3.4.13	<b>PDP-Status Word</b> PNU968 which specifies the status word sent to PLC.	1, 2, 3, 4	RO
2621	P20.3.4.14	<b>PDP-Max Block Length</b> PNU974.0 which specifies the maximum block length in byte, for the parameter request and response block, which is supported by the parameter manager.	1, 2, 3, 4	RO
2622	P20.3.4.15	<b>PDP-No Of Multi-parameter</b> PNU974.1 which specifies the max. number of parameter requests per multi-parameter request: 0 = Reserved. 1 = The parameter manager does not support multi-parameter access service.	1, 2, 3, 4	RO
2623	P20.3.4.16	<b>PDP-Max Latency</b> PNU974.2 which specifies the maximum latency time for the processing of a parameter request (time between request and response without time consumed on the communication line for a worst case scenario). The latency time is calculated by multiplication of the value in this subindex with 10 ms.	1, 2, 3, 4	RO
2624	P20.3.4.17	<b>PDP-DO Manufacturer</b> PNU975.0 which specifies the manufacturer code.	1, 2, 3, 4	RO
1451	P20.3.4.18	<b>PDP-DO Device Type</b> PNU975.1 which specifies the manufacturer product code.	1, 2, 3, 4	RO
2625	P20.3.4.19	<b>PDP-DO FW-Interface</b> PNU975.2 which specifies the product firmware version.	1, 2, 3, 4	RO
2626	P20.3.4.20	<b>PDP-DO FW-Year</b> PNU975.3 which specifies the firmware version year.	1, 2, 3, 4	RO
2627	P20.3.4.21	<b>PDP-DO FW-Day Month</b> PNU975.4 which specifies the firmware version DD MM.	1, 2, 3, 4	RO

Modbus ID	Code	Parameters	Application	RO/RW
2628	P20.3.4.22	<b>PDP-DO NoOfDOs</b> PNU975.5 which specifies the PROFIdrive DO type class: Bit:0 = Axis type implementation.	1, 2, 3, 4	RO
2629	P20.3.4.23	<b>PDP-DO Subclass</b> PNU975.6 which specifies the PROFIdrive DO sub class 1: Bit:0 = Application Class 1 supported.	1, 2, 3, 4	RO
1500	P20.4.1	<b>IP Address Mode</b> This parameter defined the IP address configuration mode for EIP/Modbus TCP. 0 = Static IP. 1 = DHCP with AutoIP.	1, 2, 3, 4	RW
1507	P20.4.2	<b>Active IP Address</b> Reads the current active IP address.	1, 2, 3, 4	RO
1509	P20.4.3	<b>Active Subnet Mask</b> Reads the current active Subnet mask.	1, 2, 3, 4	RO
1511	P20.4.4	<b>Active Default Gateway</b> Reads the current active default gateway.	1, 2, 3, 4	RO
1513	P20.4.5	<b>MAC Address</b> Reads the current MAC address.	1, 2, 3, 4	RO
1501	P20.4.6	<b>Static IP Address</b> Defines the static IP address.	1, 2, 3, 4	RW
1503	P20.4.7	<b>Static Subnet Mask</b> Defines the static Subnet mask.	1, 2, 3, 4	RW
1505	P20.4.8	<b>Static Default Gateway</b> Defines the static default gateway.	1, 2, 3, 4	RW
608	P20.4.9	<b>Ethernet IP Protocol Status</b> Indicates if ethernet protocol is active or not. 0 = Off. 1 = Operational. 2 = Faulted.	1, 2, 3, 4	RO
2518	P20.4.10	<b>EIP Fault Response</b> Defines the Fieldbus fault condition for ethernet IP communication. 0 = Only in Fieldbus control mode - When Fieldbus is the control place and Fieldbus fault is active, the drive will fault on loss of communications. If not in Fieldbus control, place will not fault. 1 = In all control modes - No matter the control place setting, if communication is lost, Fieldbus fault response will occur.	1, 2, 3, 4	RW
609	P20.5.1	<b>Connection Limit</b> Maximum number of connections allowed to the drive.	1, 2, 3, 4	RO
610	P20.5.2	<b>Modbus TCP Unit ID</b> Unit identifier unit value for Modbus TCP.	1, 2, 3, 4	RW
611	P20.5.3	<b>Comm Timeout Modbus TCP</b> Selects the time it waits before a communication fault occurs over Ethernet.	1, 2, 3, 4	RW
612	P20.5.4	<b>Modbus TCP Protocol Status</b> This parameter shows the protocol status for Modbus TCP communication. 0 = Stopped. 1 = Operational. 2 = Faulted.	1, 2, 3, 4	RW
2517	P20.5.5	<b>Modbus TCP Fault Response</b> Defines the Fieldbus fault condition for Modbus TCP communication. 0 = Only in Fieldbus control mode - When Fieldbus is the control place and Fieldbus fault is active, the drive will fault on loss of communications. If not in Fieldbus control, place will not fault. 1 = In all control modes - No matter the control place setting, if communication is lost, Fieldbus fault response will occur.	1, 2, 3, 4	RW

## Appendix A—Description of parameters

Modbus ID	Code	Parameters	Application	RO/RW
74	P20.5.6	<b>Modbus TCP Trusted IP Enable</b> Defines the IP addresses in the white list, a setting of 192.168.1.255 enables all connections on the local subnet.	1, 2, 3, 4	RW
608	P20.5.7	<b>Trusted IP White List</b> Enables IP white listing, devices not in the white list will not be able to establish communications with the drive.	1, 2, 3, 4	RW
2915	P20.6.1	<b>WebUI Protocol Status</b> This parameter shows the protocol status for webserver communication. 0 = Off. 1 = Operational. 2 = Faulted.	1, 2, 3, 4	RO
2916	P20.6.2	<b>WebUI Fault Response</b> Defines the Fieldbus fault condition for webserver communication. 0 = Only in Fieldbus control mode - When Fieldbus is the control place and Fieldbus fault is active, drive will fault on loss of communications, if not in Fieldbus control place will not fault. 1 = In all control modes - No matter the control place setting, if communication is lost Fieldbus fault response will occur.	1, 2, 3, 4	RW
2919	P20.6.3	<b>WebUI Communication Timeout</b> Selects the time it waits before a communication fault occurs over the webserver.	1, 2, 3, 4	RW
2921	P20.6.4	<b>WebUI Enable</b> Enables Webserver configuration and monitoring page.	1, 2, 3, 4	RW
340	P21.1.1	<b>Language</b> This parameter offers the ability to control the frequency converter through the keypad in the language of your choice. Currently available language is only English.	1, 2, 3, 4	RW
142	P21.1.2	<b>Application</b> Use this parameter to set the active application marco to use.	1, 2, 3, 4	RW
619	P21.1.3	<b>Parameter Sets</b> This parameter allows you to reload the factory default parameter values, and to store and load two customized parameter sets. 0 = No. 1 = Load factory default parameters. 2 = Reload set 1. 3 = Reload set 2. 4 = Store parameter set1. 5 = Store parameter set2. 6 = Reset. 7 = Reload defaults VM.	1, 2, 3, 4	RW
620	P21.1.4	<b>Up to Keypad</b> This function uploads all existing parameter groups to the keypad. 0 = No . 1 = Yes (all parameters).	1, 2, 3, 4	RW
621	P21.1.5	<b>Down from Keypad</b> This function downloads one or all parameter groups from the keypad to the drive. 0 = No. 1 = Yes (all parameters).	1, 2, 3, 4	RW

Modbus ID	Code	Parameters	Application	RO/RW
623	P21.1.6	<p><b>Param Comparison</b></p> <p>Use this parameter to initiate a parameter comparison function. You can compare the actual parameter values to the values of your customized parameter sets and those loaded to the control keypad.</p> <p>The actual parameter values are first compared to those of the customized parameter set1. If no differences are detected, a "0" is displayed on the lowermost line of the keypad.</p> <p>If any of the parameter values differ from those of the set1 parameters, the number of the deviations is displayed together.</p> <p>By pressing the right arrow button once again, you will see both the actual value and the value it was compared to. In this display, the value on the description line (in the middle) is the default value, and the one on the value line (lowermost line) is the edited value. You can also edit the actual value by pushing the right arrow button.</p> <p>Actual values can also be compared to set2, factory settings and keypad set values.</p>	1, 2, 3, 4	RW
624	P21.1.7	<p><b>Password</b></p> <p>The application selection can be protected against unauthorized changes with the password function. When the password function is enabled, the user will be prompted to enter a password before application changes, parameter value changes, or password changes.</p> <p>By default, the password function is not in use. If you want to activate the password, change the value of this parameter to any number between 1 and 9999.</p> <p>To deactivate the password, reset the parameter value to 0.</p>	1, 2, 3, 4	RW
625	P21.1.8	<p><b>Parameter Lock</b></p> <p>Use this parameter to prevent user from changing parameters. User has to come to the parameter to allow changing. When the parameter lock is activated, the text *locked* will appear on the display if you try to edit a parameter value.</p> <p><b>Note:</b> This function does not prevent unauthorized editing of parameter values.</p>	1, 2, 3, 4	RW
627	P21.1.9	<p><b>Multi-monitor Set</b></p> <p>Use this parameter lock in the values set for the multi-monitor page and not allow changing unless re-enabled.</p>	1, 2, 3, 4	RW
628	P21.1.10	<p><b>Default Page</b></p> <p>This parameter sets the view to which the display automatically moves as the time-out time expires or when the keypad power is switched on.</p> <p>If the default page value is 0, the function is not activated, i.e., the last displayed page remains on the keypad display.</p>	1, 2, 3, 4	RW
629	P21.1.11	<p><b>Time-out Time</b></p> <p>Use this parameter to set the time after which the keypad display returns to the default page, if no keypad keys are pressed.</p> <p><b>Note:</b> If the default page value is 0, the Time-out time setting has no effect.</p>	1, 2, 3, 4	RW
630	P21.1.12	<p><b>Contrast Adjust</b></p> <p>If the remote keypad display is not clear, you can adjust the keypad contrast with this parameter.</p>	1, 2, 3, 4	RW
631	P21.1.13	<p><b>Backlight Time</b></p> <p>Use this parameter to set the time to illuminate the display.</p>	1, 2, 3, 4	RW
632	P21.1.14	<p><b>Fan Control</b></p> <p>This function allows you to control the drive cooling fan. You can set the fan to run:</p> <p>0 = Continuous-fan runs continuously.</p> <p>1 = Temperature - Based on the temperature of the unit. The fan is switched on automatically when the heat sink temperature reaches 60°C. The fan receives a stop command when the heat sink temperature falls to 55°C. The fan runs for about a minute after receiving the stop command or switching on the power, as well as after changing the value from "Continuous" to "Temperature."</p> <p>2 = Run follow - After power up, the fan is stopped until the run command is given and then fan runs continuously. This is mainly made for common DC-bus systems to prevent cooling fans to load charging resistors on power up moment.</p>	1, 2, 3, 4	RW

## Appendix A—Description of parameters

Modbus ID	Code	Parameters	Application	RO/RW
633	P21.1.15	<p><b>Keypad ACK Time-out</b></p> <p>This function allows the user to change the time-out of the keypad acknowledgement time. This is the communication performed between the control module and the keypad. This would be adjusted when using long communication cables between drive and a keypad to delay message time-outs.</p> <p><b>Example:</b></p> <ul style="list-style-type: none"> <li>• Transfer delay between the frequency converter and the PC = 600 ms.</li> <li>• The value of HMI acknowledge time-out is set to 1200 ms (2 x 600, sending delay + receiving delay).</li> <li>• The corresponding setting shall be entered in the [Misc]-part of the file.</li> <li>• It must also be considered that intervals shorter than the HMI acknowledge time-out time cannot be used in frequency converter drive monitoring.</li> </ul>	1, 2, 3, 4	RW
634	P21.1.16	<p><b>Keypad Retry Number</b></p> <p>With this parameter, you can set the number of times the drive will try to receive acknowledgement when it has not been received within the acknowledgement time (HMI acknowledge time-out) or if the received acknowledgement is faulty.</p>	1, 2, 3, 4	RW
626	P21.1.17	<p><b>Startup Wizard</b></p> <p>The Startup Wizard facilitates commissioning the drive. If selected enable, the Startup Wizard prompts operator for application desired and then advances parameters through the start-up parameter list/ Application Mini wizard in keypad. After completion, it allows the user to go to the main menu or default page and this parameter is set to disabled. The Startup Wizard is always enabled for the initial power up of the drive Pro. By setting this parameter to disable without going through the Startup Wizard, it will not cause it to be active on start up. If user goes into Start Up Wizard after completion or defaults drive, the Startup Wizard will be enabled.</p> <p>0 = Enabled. 1 = Disabled.</p>	1, 2, 3, 4	RW
2412	P21.1.18	<p><b>Jog Soft Key Hidden</b></p> <p>Use this parameter to hide the jog function from the soft key buttons.</p> <p>0 = Disable. 1 = Enable.</p>	1, 2, 3, 4	RW
2413	P21.1.19	<p><b>Reverse Soft Key Hidden</b></p> <p>Use this parameter to hide the reverse function from the soft key buttons.</p> <p>0 = Disable. 1 = Enable.</p>	1, 2, 3, 4	RW

Modbus ID	Code	Parameters	Application	RO/RW
2424	P21.1.20	<p><b>Output Display Unit</b></p> <p>Allows for changing the monitor value to a desired unit that will reflect the application. From there with process unit it will allow setting a min./max. limit for the value to display desired output.</p> <p>0, PERCENTAGE, %;</p> <p>1 = 1/min;</p> <p>2 = rpm;</p> <p>3 = ppm;</p> <p>4 = pps;</p> <p>5 = l/s;</p> <p>6 = l/min;</p> <p>7 = l/h;</p> <p>8 = kg/s;</p> <p>9 = kg/min;</p> <p>10 = kg/h;</p> <p>11 = m3/s;</p> <p>12 = m3/min;</p> <p>13 = m3/h;</p> <p>14 = m/s;</p> <p>15 = mbar;</p> <p>16 = bar;</p> <p>17 = Pa;</p> <p>18 = kPa;</p> <p>19 = mVS;</p> <p>20 = kW;</p> <p>21 = Deg. C;</p> <p>22 = GPM;</p> <p>23 = gal/s;</p> <p>24 = gal/min;</p> <p>25 = gal/h;</p> <p>26 = lb/s;</p> <p>27 = lb/min;</p> <p>28 = lb/h;</p> <p>29 = CFM;</p> <p>30 = ft3/s;</p> <p>31 = ft3/min;</p> <p>32 = ft3/h;</p> <p>33 = ft/s;</p> <p>34 = in w/g;</p> <p>35 = ft w/g;</p> <p>36 = PSI;</p> <p>37 = lb/in2;</p> <p>38 = HP;</p> <p>39 = Deg. F;</p> <p>40 = PA;</p> <p>41 = WC;</p> <p>42 = HG;</p> <p>43 = ft;</p> <p>44 = m;</p> <p>45 = Hz;</p> <p>46 = strokes/min</p>	1, 2, 3, 4	RW
2460	P21.1.21	<p><b>Output Display Unit Min.</b></p> <p>Use this parameter to set the minimum scaled value when changing the display unit to a value other than the default Hz.</p>	1, 2, 3, 4	RW
2425	P21.1.22	<p><b>Output Display Unit Max.</b></p> <p>Use this parameter to set the maximum scaled value when changing the display unit to a value other than the default Hz.</p>	1, 2, 3, 4	RW
75	P21.1.23	<p><b>Keypad Lock Password</b></p> <p>The keypad can be protected against unauthorized changes with the keypad lock function after no keys have been pressed for 5 minutes. When the password function is enabled, the user will be prompted to enter a password before keypad display parameter or response to key press except up/down/left/right.</p> <p>By default, the password function is not in use. If you want to activate the password, change the value of this parameter to any number between 1 and 9999.</p> <p>To deactivate the password, reset the parameter value to 0.</p>	1, 2, 3, 4	RW

## Appendix A—Description of parameters

Modbus ID	Code	Parameters	Application	RO/RW
640	P21.2.1	<b>Keypad Software Version</b> Keypad Firmware Version.	1, 2, 3, 4	RO
642	P21.2.2	<b>Motor Control Software Version</b> DSP/motor control software version.	1, 2, 3, 4	RO
644	P21.2.3	<b>Application Software Version</b> MCU/application software version.	1, 2, 3, 4	RO
1714	P21.2.4	<b>Software Bundle Version</b> Software bundle version.	1, 2, 3, 4	RO
646	P21.3.1	<b>Brake Chopper</b> This parameter is used to provide a status to indicate if the unit has a brake chopper installed in it.	1, 2, 3, 4	RO
647	P21.3.2	<b>Brake Resistor</b> The hardware information - Indication of the brake resistor status being connected or disconnected.	1, 2, 3, 4	RO
648	P21.3.3	<b>Serial Number</b> Serial number of the drive.	1, 2, 3, 4	RO
1270	P21.3.4	<b>Power Unit Serial Number</b> Power unit serial number.	1, 2, 3, 4	RO
1276	P21.3.5	<b>Control Unit Serial Number</b> Control board serial number.	1, 2, 3, 4	RO
566	P21.4.1	<b>Real Time Clock</b> This parameter provides the ability to see and adjust the time clock settings in the drive. Formatted in MM.DD.YY, HH:MM:SS.	1, 2, 3, 4	RW
582	P21.4.2	<b>Daylight Saving</b> This parameter provides the ability to see and adjust the daylight saving time rule. 0 = Off. 1 = EU. 2 = US.	1, 2, 3, 4	RW
601	P21.4.3	<b>Total MWh count</b> Energy consumption MWh meter (not re-settable).	1, 2, 3, 4	RO
603	P21.4.4	<b>Total Power Day Count</b> Total time power is on, days count (not re-settable).	1, 2, 3, 4	RO
606	P21.4.5	<b>Total Power Hr Count</b> Total time power is on, hours count (not re-settable).	1, 2, 3, 4	RO
604	P21.4.6	<b>Trip MWh Count</b> Energy consumption MWh meter (re-settable).	1, 2, 3, 4	RW
635	P21.4.7	<b>Clear Trip MWh Count</b> Resets megawatts hours counter and clears energy meter in the menu.	1, 2, 3, 4	RW
636	P21.4.8	<b>Trip Power Day Count</b> Time power is on, days count (re-settable).	1, 2, 3, 4	RW
637	P21.4.9	<b>Trip Power Hr Count</b> Number of hours the drive has been running a motor since the last reset.	1, 2, 3, 4	RW
639	P21.4.10	<b>Clear Trip Power Count</b> This parameter will reset the trip power on day and hour count.	1, 2, 3, 4	RW



## Appendix B—Fault log

Under this menu, you can find Active faults, History faults and Fault codes.

**Table 204. Active faults.**

Menu	Function	Note
Active Faults	When a fault/faults appear(s), the display with the name and fault time of the fault will be pop. Press DETAIL to see the fault data. The Active Faults submenu shows the list of faults. Select the fault and push DETAIL to see the fault data.	The fault remains active until it is cleared with the Reset button (push for 2s) or with a reset signal from the I/O terminal or Fieldbus. The memory of active faults can store the maximum of 10 faults in the order of appearance.

**Table 205. History faults.**

Menu	Function	Note
History Faults	10 latest faults are stored in the Fault history, Select the fault and push DETAIL to see the fault data.	The history fault will be stored until it is cleared with the OK button (push for 5s). The memory of active faults can store the maximum of 10 faults in the order of appearance.

### Fault codes and descriptions

Configurable 1 = The fault type of this fault is configurable, fault type can be configured as  
0 = No Action; 1 = Warning; 2 = Fault; 3= Fault, Coast

Fault code	Fault name	Fault type	Default fault type	Possible cause	Remedy	Realization
1	Over Current	Fault		AC drive has detected too high a current (>4*I <sub>H</sub> ) in the motor cable: <ul style="list-style-type: none"> <li>Sudden heavy load increase</li> <li>Short circuit in motor cables</li> <li>Unsuitable motor</li> </ul>	<ul style="list-style-type: none"> <li>Check loading</li> <li>Check motor</li> <li>Check cables and connections</li> <li>Make identification run</li> <li>Check ramp times</li> </ul>	DSP
2	Over Voltage	Fault		The DC-link voltage has exceeded the limits defined: <ul style="list-style-type: none"> <li>Too short a deceleration time</li> <li>Brake chopper is disabled</li> <li>High overvoltage spikes in supply</li> <li>Start/Stop sequence too fast</li> </ul>	<ul style="list-style-type: none"> <li>Make deceleration time longer</li> <li>Use brake chopper or brake resistor (available as options)</li> <li>Activate overvoltage controller</li> <li>Check input voltage</li> </ul>	DSP
3	Earth Fault	Configurable	Fault	Current measurement has detected that the sum of motor phase current is not zero: <ul style="list-style-type: none"> <li>Insulation failure in cables or motor</li> </ul>	Check motor cables and motor	DSP
5	Charging Switch	Fault		The charging switch is open, when the START command has been given: <ul style="list-style-type: none"> <li>Faulty operation</li> <li>Component failure</li> </ul>	<ul style="list-style-type: none"> <li>Reset the fault and restart</li> <li>Should the fault re-occur, contact the distributor near to you</li> </ul>	DSP
6	Emergency Stop (Ext. Fault-AR)	Fault		<ul style="list-style-type: none"> <li>Emergency signal from DI is inactive.</li> </ul>	<ul style="list-style-type: none"> <li>Close input signal from DI.</li> </ul>	MCU
7	Saturation Trip	Fault		<ul style="list-style-type: none"> <li>Short circuit in motor cables.</li> <li>IGBT module is damaged.</li> </ul>	Check cables and connections. Reset the fault and restart. Verify that EMC screw is installed. Should the fault re-occur, contact the distributor near to you.	DSP
9	UnderVoltage	Configurable	Fault	DC link voltage is under the voltage limits defined: <ul style="list-style-type: none"> <li>Most probable cause: Too low a supply voltage</li> <li>AC drive internal fault</li> <li>Defect input fuse</li> <li>External charge switch not closed</li> </ul> <b>Note:</b> This fault is activated only if the drive is in Run state.	In case of temporary supply voltage break reset the fault and restart the AC drive Check the supply voltage. If it is adequate, an internal failure has occurred. Contact the distributor near you	DSP
10	Input Phase Superv	Configurable	Fault	Input line phase is missing	Check supply voltage, fuses and cable	DSP

## Appendix B—Fault log

Fault code	Fault name	Fault type	Default fault type	Possible cause	Remedy	Realization
11	Output Phase Superv	Configurable	Fault	Current measurement has detected that there is no current in one motor phase	Check motor cable and motor	DSP
12	Brake Chopper Superv	Fault		<ul style="list-style-type: none"> <li>No brake resistor installed</li> <li>Brake resistor is broken</li> <li>Brake chopper failure</li> </ul>	Check brake resistor and cabling. If these DSP are OK, the chopper is faulty. Contact the distributor near you	DSP
13	Drive UnderTemp	Configurable	Warning	Too low temperature measured in power unit's heat sink or board. Heat sink temperature is under $-10^{\circ}\text{C}$ .		DSP
14	Drive OverTemp	Fault		Too high temperature measured in power unit's heat sink or board. Heat sink temperature is over $90^{\circ}\text{C}$ .	<ul style="list-style-type: none"> <li>Check the correct amount and flow of DSP cooling air</li> <li>Check the heat sink for dust</li> <li>Check the ambient temperature</li> <li>Make sure that the switching frequency is not too high in relation to ambient temperature and motor load</li> </ul>	
15	Motor Stalled	Configurable	No Action	Motor is stalled.	Check motor and load	DSP
16	Motor Over Temp	Configurable	No Action	Motor is too hot, based on either the drive's estimate or on temperature feedback.	Decrease motor load. If no motor overload exists, check the temperature model parameters	DSP
17	Motor Under Load	Configurable	No Action	Condition defined by parameter P1.9.15–P1.9.17 have been valid longer than the time defined by P1.9.18.	Check load	DSP
18	IP Address Conflict	Configurable	Warning	IP setting issue.	Check settings for IP address, verify no duplicates are on the network.	MCU
19	Power Board EEPROM Fault	Fault		Power board EEPROM fault, memory lost in EEPROM.	Cycle power to drive. Try updating software, if issue continues contact Distributor near you.	MCU
20	FRAM Fault	Fault		FRAM data error in FRAM memory.	Cycle power to drive. Try updating software, if issue continues contact a Distributor near you.	MCU
21	S-Flash Fault	warning		Serial flash error, serial flash memory failed.	Cycle power to drive. Try updating software, if issue continues contact a Distributor near you.	MCU
25	MCU WatchDog Fault	Fault		Watchdog register overflows in MCU.	Cycle power to drive. Try updating software, if issue continues contact a Distributor near you.	MCU
26	Start-up Prevent	Fault		The time when Interlock signal activates is over setting time.	Stop drive and resend start command.	MCU
29	Thermistor Fault	Configurable	Fault	Option board or control board thermistor resistor larger than 4.7K	Thermistor open or short, over temperature	MCU
32	Fan Cooling	Fault		Fan is damaged or stalled.	Check fan and fan connected wires, verify 24 Vdc is supplied to fan.	DSP
36	Compatibility Fault	Fault		The control board isn't match with the power board.	Cycle power to drive. Try updating software, if issue continues contact a Distributor near you.	MCU
37	Device Change	Warning		Power board or option card change.	Alarm will reset	MCU
38	Device Added	Warning		Power board or option board added.	Device is ready for use Old parameter settings will be used	MCU
39	Device Removed	Fault		Optional board removed from slot, or power board removed from control board.	Device no longer available in drive.	MCU
40	Device Unknown	Fault			"Check EEPROM connection. Check board connection on slot A/B Power cycle to drive."	MCU
41	IGBT Over Temp	Fault		IGBT temperature is too high.	<ul style="list-style-type: none"> <li>Check output loading</li> <li>Check motor size</li> <li>Decrease switching frequency</li> </ul>	DSP
50	AI < 4 mA (4 to 20 mA)	Configurable	No Action	Loss in analog input signal, dropped below 4 mA.	Verify analog input current reference value on either AI1 or AI2, check cabling.	MCU

Fault code	Fault name	Fault type	Default fault type	Possible cause	Remedy	Realization
51	External Fault	Configurable	Fault	Digital input is activated for external fault input. • The real time isn't normal	Check digital input settings and verify input level, could be an external device causing fault.	MCU
52	Keypad Comm. Fault	Configurable	Fault	The connection between the control keypad and frequency converter is broken.	Check keypad connection and possible keypad cable. Check the local reference is keypad reference or the local control place is keypad, and the keypad communication fault protection is not "NO action".	MCU
54	Option Card Fault	Configurable	Fault	Defective option card or option card slot.	Check right option card and option card slot connections. Check board status on keypad for exact cause of fault. Contact distributor nearest you.	MCU
55	Real Time Clock fault	Configurable	Warning	• Communication between MCU and RTC chip is not normal. • The power of RTC chip is not normal. • The real time is not normal.	Check the RTC chip, power cycle to drive.MCU If issue continues, contact distributor near you.	MCU
56	PT100 Fault	Configurable	Fault	Temperature is beyond the limit of sensing capacity of PT100.	PT100 short, open or over temperature, check PT100 temperature probe.	MCU
57	Motor ID fault	Fault		The Motor parameters Identification running was not completed successfully.	Check motor size. Verify the input and output wiring is connected properly.	DSP
58	Current Measure Fault	Fault		Current measurement is out of range.	Restart the drive again. Should the fault re-occur, contact the distributor near to you.	DSP
60	Control Board OverTemp	Fault		Control board is over +85 degrees or under -30 degrees.	Check NTC resistor. Check control board temperature.	MCU
61	Internal Control Supply	Fault		+24V port voltage is over 27V or under 17V.	Check voltage range of +24V on terminals 12 to 13. If voltage is out of range contact distributor near you.	MCU
63	Current Unbalance	Fault	Fault	Frame 8 only: current unbalanced between power units.	Check the motor cables and connections. MCU Check the output filters (dV/dt, sine). Reset the fault and restart the drive. If the fault recurs, contact your local/nearest service center or distributor. Please, report carefully all the used software, application and all options.	MCU
64	Replace Battery	Configurable	Warning	RTC Battery voltage is too low.	Check the RTC battery voltage, contact distributor near you for replacement battery.	MCU
65	Replace Fan	Configurable	Warning	Fan life is less than 2 months.	Check the fan, clean out any contamination, contact distributor near you for replacement fan.	MCU
66	Safe Torque Off	Fault		STO Triggered, STO input is open.	Reset STO Trigger and verify wiring. Reset fault after input is enabled.	DSP
67	Current Limit Control	Warning		The output current has reached the current limit value.	Check the load. Set the acceleration time longer.	DSP
68	Over Voltage Control	Warning		The DC link voltage has reached its voltage limit value.	Check the input voltage. Set the acceleration/deceleration time longer.	DSP
69	System Fault	Fault		Thermistor spi communication error.	Check thermistor chip.	MCU
70	System Fault	Fault		MCU send wrong parameters to DSP.	Restart the drive again. Should the fault re-occur, contact the distributor near to you.	DSP
71	System Fault	Fault		MCU and DSP communication error.	Restart the drive again. Should the fault re-occur, contact the distributor near to you.	MCU
72	Power Board EEPROM Fault	Fault		Power board EEPROM fault, memory lost in EEPROM when initial drive (for FR7 and FR8 only).	Cycle power to drive. Try updating software, if issue continues contact Distributor near you.	MCU

## Appendix B—Fault log

<b>Fault code</b>	<b>Fault name</b>	<b>Fault type</b>	<b>Default fault type</b>	<b>Possible cause</b>	<b>Remedy</b>	<b>Realization</b>
73	FRAM Fault	Fault		FRAM chip is broken (for FR7 and FR8 only).	Contact Distributor near you.	MCU
74	FRAM Fault	Fault		CRC check fault when access FRAM data (for FR7 and FR8 only).	Try recovery factory default setting if issue continues contact Distributor near you.	MCU
75	Power Board EEPROM Fault	Fault		EEPROM chipor I2c circuit is broken (for FR7 and FR8 only).	Contact Distributor near you.	MCU
76	Power Board EEPROM Fault	Fault		CRC check fault when access EEPROM data (for FR7 and FR8 only).	Try recovery factory default setting if issue continues contact Distributor near you.	MCU
77	S-Flash Fault	Warning		External serial flash chip is broken (for FR7 and FR8 only).	Contact Distributor near you.	MCU
80	Fieldbus Fault	Configurable	Fault	Loss of communication with BACnet MSTP, and the fieldbus reference is the remote reference OR the fieldbus control place is the remote control place.	Check BACnet MSTP communication wiring. Verify drive parameter are set correctly. Check master programming to verify proper addressing.	MCU
82	Bypass Overload	Fault		Over load when motor is in bypass mode	Check motor connection situation.	MCU
83	Fieldbus Fault	Configurable	Fault	Loss of communication with Modbus RTU, and the fieldbus reference is the remote reference OR the fieldbus control place is the remote control place.	Check RS-485 communication wiring. Verify drive parameter are set correctly. Check master programming to verify proper addressing.	MCU
84	Fieldbus Fault	Configurable	Fault	Loss of communication with Modbus TCP, and the fieldbus reference is the remote reference OR the fieldbus control place is the remote control place.	Check Ethernet communication wiring. Verify drive parameter are set correctly. Check master programming to verify proper addressing.	MCU
85	Fieldbus Fault	Configurable	Fault	Loss of communication with BACnet, and the fieldbus reference is the remote reference OR the fieldbus control place is the remote control place, and the fault protection is not "NO action".	Check RS-485 communication wiring. Verify drive parameter are set correctly. Check BACnet master configuration programming to verify proper addressing.	MCU
86	Fieldbus Fault	Configurable	Fault	Loss of communication with EtherNet/IP, and the fieldbus reference is the remote reference OR the fieldbus control place is the remote control place, and the fault protection is not "NO action".	Check Ethernet communication wiring. Verify drive parameter are set correctly. Check EIP master configuration programming to verify proper addressing.	MCU
87	Fieldbus Fault	Configurable	Fault	Loss of communication with Profibus/Canopen/Devicenet master on Slot A, and the fieldbus reference is the remote reference OR the fieldbus control place is the remote control place, and the fault protection is not "NO action".	Check Profibus/Canopen/Devicenet communication wiring. Verify drive parameter are set correctly. Check Profibus/Canopen/Devicenet master configuration programming to verify proper addressing.	MCU
88	Fieldbus Fault	Configurable	Fault	Loss of communication with Profibus/Canopen/Devicenet master on Slot B, and the fieldbus reference is the remote reference OR the fieldbus control place is the remote control place, and the fault protection is not "NO action".	Check Profibus/Canopen/Devicenet communication wiring. Verify drive parameter are set correctly. Check Profibus/Canopen/Devicenet master configuration programming to verify proper addressing.	MCU
89	Under Voltage Stop	Fault		The DC link voltage has reached the Drive under voltage stop limit value.	Check the input voltage.	DSP

Fault code	Fault name	Fault type	Default fault type	Possible cause	Remedy	Realization
90	Drive Under Temp	Warning/Fault		<ul style="list-style-type: none"> <li>Cold weather mode is not enabled, and unit temperature is less than -10 degree</li> <li>Cold weather mode is enabled and Under Temp Fault Override is not set, unit temperature is less than -30 degree</li> <li>Cold weather mode is enabled and Under Temp Fault Override is not set, unit temperature is -20~-30 degree. The temp &lt;-20 degree when cold weather start time out</li> </ul>	<p>If unit temp -20 ~ -10 degree, start motor DSP in cold weather mode.</p> <p>If unit temp &lt;-20 degree, Warm up unit above -20 deg C for proper operation using cold weather mode. If still &lt; -20 degree when cold weather mode time out, try higher output voltage in cold weather mode.</p>	
91	Option Card Fault	Configurable	Fault	External supply on the DeviceNet communication connector is not present.	Check voltage and wiring of power supply of the DeviceNet communication.	MCU
92	External Fault 2	Configurable	Fault	Digital input is activated for external fault input.	Check digital input settings and verify input level, could be an external device causing fault.	MCU
93	External Fault 3	Configurable	Fault	Digital input is activated for external fault input.	Check digital input settings and verify input level, could be an external device causing fault.	MCU
94	Pump Lost	Fault		<ul style="list-style-type: none"> <li>In single drive control mode of MPFC, include FC, interlock enable, and all interlock signals lost.</li> <li>In single drive control mode of MPFC, not include FC, interlock enable, and interlock 1 lost.</li> <li>In multi drive network mode of MPFC, interlock enable, and interlock 1 lost.</li> </ul>	Check digital inputs for interlock.	MCU
95	Need Alteration	Warning		In multi drive network mode of MPFC, run time counter enable and is over limit.	Need to do motor maintenance and then reset run time counter to clear the warning.	MCU
97	Pipe Fill Loss	Configurable	No action	<ul style="list-style-type: none"> <li>If prime pump is disabled, the pipe fill detection value (motor current, motor power or motor torque) is less than pipe fill loss setting level.</li> <li>If prime pump is enabled and the drive in the prime pump level1 phase, the pipe fill detection value (motor current, motor power or motor torque) is less than prime pump level1 value.</li> <li>If prime pump is enabled and the drive in the prime pump level2 phase, the pipe fill detection value (motor current, motor power or motor torque) is less than prime pump level2 value.</li> <li>If PID feedback AI is lost and the feedback AI loss protection is warning: Preset Freq, the pipe fill detection value (motor current, motor power or motor torque) is less than pipe fill loss setting level of PID feedback AI loss.</li> </ul>	Check the motor current/power/torque of drive.	MCU
98	PID Feedback AI Loss	Configurable	No action	The feedback function has relationship with feedback 1/2 and the feedback 1/2 source has relationship with AI, the AI signal range is 1 (20-100%/2-10 V/4-20 mA), the AI value is out of range (AI mode: 0-20 mA, AI < 4 mA or AI > 20 mA, AI mode: 0-10 V, AI < 2 V or AI > 10 V) of PID1 feedback.	Check the AI of PID1 feedback, the AI value whether is out of range or not, the AI range shall be 2-10 V ( AI mode is 0-10 V) or 4-20 mA(AI mode is 0-20 mA).	MCU

## Appendix B—Fault log

Fault code	Fault name	Fault type	Default fault type	Possible cause	Remedy	Realization
99	PID Feedback AI Loss	Configurable	No action	The feedback function has relationship with feedback 1/2 and the feedback 1/2 source has relationship with AI, the AI signal range is 1 (20-100%/2-10 V/4-20 mA), the AI value is out of range (AI mode: 0-20 mA, AI < 4 mA or AI > 20 mA, AI mode: 0-10 V, AI < 2 V or AI > 10V) of PID2 feedback.	Check the AI of PID2 feedback, the AI value whether is out of range or not, the AI range shall be 2-10 V ( AI mode is 0-10 V) or 4-20 mA (AI mode is 0-20 mA).	MCU
100	Fieldbus Fault	Configurable	Fault	Smart Wire BUS fieldbus fault.	Check Smart Wire DT communication for MCU loss of connectivity.	
101	Option Card Fault	Configurable		SMDT board hardware fault.	Check Smart Wire DT card for healthy operation.	MCU
102	External Fault	Configurable	Fault	External fault from SWD.	Check Smart Wire DT card for external fault configuration.	MCU
103	Drive Over Temp Warning	Warning		Drive is 10 degrees away from trip point of 90 deg C.	Check the drive degree.	DSP
104	Compatibility Fault	Warning		DSP firmware is not compatible with MCB firmware.	Check the DSP firmware revision.	MCU
105	Compatibility Fault	Warning		Keypad firmware is not compatible with MCB firmware.	Check the keypad firmware revision.	MCU
106	Compatibility Fault	Warning		IO1 card firmware is not compatible with MCB firmware	Check the IO1 card firmware revision	MCU
107	Compatibility Fault	Warning		IO2 card firmware is not compatible with MCB firmware	Check the IO2 card firmware revision	MCU
108	Compatibility Fault	Warning		IO3 card firmware is not compatible with MCB firmware	Check the IO3 card firmware revision	MCU
109	Compatibility Fault	Warning		IO4 card firmware is not compatible with MCB firmware	Check the IO4 card firmware revision	MCU
110	Compatibility Fault	Warning		IO5 card firmware is not compatible with MCB firmware	Check the IO5 card firmware revision	MCU
111	Compatibility Fault	Warning		Profibus card firmware is not compatible with MCB firmware	Check the Profibus card firmware revision	MCU
112	Compatibility Fault	Warning		DeviceNet card firmware is not compatible with MCB firmware	Check the DeviceNet card firmware revision	MCU
113	Compatibility Fault	Warning		CANOpen card firmware is not compatible with MCB firmware	Check the CANOpen firmware revision	MCU
114	Compatibility Fault	Warning		SWD card firmware is not compatible with MCB firmware	Check the SWD card firmware revision	MCU
115	Fieldbus Fault			FieldBus EIP idle fault	Check EtherNet IP master programming to verify proper addressing and ensure Idle communication bit is not set.	MCU
118	Reset the fault and restart the drive.	Configurable	No Action	PID feedback is less than broken pipe level and the drive output frequency is more than broke pipe frequency for delay time.		MCU
120	If the fault recurs, contact your local/nearest service center or distributor. Please, report carefully all the used software, application and all options.	MCU	No Action	PID1 Low feedback function is active and pid feedback is low than set value.		MCU
121	PID1 High Feedback	Configurable	No Action	PID1 high feedback function is active and pid feedback is high than set value.		MCU
122	PID2 Low Feedback	Configurable	No Action	PID2 low feedback function is active and pid feedback is low than set value.		MCU
123	PID2 High Feedback	Configurable	No Action	PID2 high feedback function is active and pid feedback is high than set value.		MCU

## Appendix C—Recommended Secure Hardening Guidelines

<b>Fault code</b>	<b>Fault name</b>	<b>Fault type</b>	<b>Default fault type</b>	<b>Possible cause</b>	<b>Remedy</b>	<b>Realization</b>
124	OP Cont Interlock Fault	Configurable	Fault	OP Cont Interlock function is active.		MCU
133	Fieldbus Fault	Configurable	Fault	FieldBus Web UI fault	Check the web connection with RJ45 connector. Verify drive parameters are set correctly. Check the Web UI tool to know if there is proper request going to drive or not.	MCU
134	Bumpless Transfer Fail	Warning	warning	There is fault currently. There is no start command from new control place after transition.	Check whether there is fault currently. Check whether there is no start command from new control place after transition.	MCU
135	CP Interlock Fault Run	Configurable	Fault	CP interlock input open and drive in run status.	Check CP interlock input.	MCU
136	CP Interlock Fault Stop	Configurable	Warning	CP interlock input open and drive in stop status.	Check CP interlock input.	MCU

## Appendix C—PowerXL Recommended secure hardening guidelines

### Introduction

This section “secure configuration” or “hardening” guidelines provide information to the users to securely deploy and maintain this product to adequately minimize the cybersecurity risks to their system.

Eaton is committed to minimizing the Cybersecurity risk in its products and deploys cybersecurity best practices and latest cybersecurity technologies in its products and solutions; making them more secure, reliable and competitive for our customers. Eaton also offers Cybersecurity Best Practices whitepapers to its customers that can be referenced at [www.eaton.com/cybersecurity](http://www.eaton.com/cybersecurity)

### PowerXL - SECURE CONFIGURATION GUIDELINES

Category	Description
Asset identification and Inventory	<p>Keeping track of all the devices in the system is a pre-requisite for effective management of Cybersecurity of a system. Ensure you maintain an inventory of all the components in your system in a manner in which you uniquely identify each component. To facilitate this PowerXL Series VFD supports the following identifying information - manufacturer, type, serial number, f/w version number, and location.</p> <p>Customers/users can read following information from product label</p> <ul style="list-style-type: none"> <li>• Model Number</li> <li>• Serial Number</li> <li>• Device Name</li> </ul> <p>Information specific to communication protocols is available from parameter menu as below</p> <ul style="list-style-type: none"> <li>• IP Address Mode</li> <li>• Active IP Address</li> <li>• MAC Address</li> </ul> <p>See application manual for these parameter locations.</p>
Restrict Physical access	<p>Industrial Control Protocols don't offer cryptographic protections at protocol level leaving them exposed to Cybersecurity risk. Physical security is an important layer of defense in such cases. PowerXL Series VFD is designed with the consideration that it would be deployed and operated in a physically secure location.</p> <ul style="list-style-type: none"> <li>• Eaton suggests that physical access to cabinets and/or enclosures containing PowerXL Series VFD and the associated system should be restricted, monitored and logged at all times.</li> <li>• Physical access to the communication lines should be restricted to prevent any attempts of wiretapping, sabotage. It's a best practice to use metal conduits for the communication lines running between one cabinet to another cabinet.</li> <li>• Attacker with unauthorized physical access to the device could cause serious disruption of the device functionality. A combination of physical access controls to the location should be used, such as locks, card readers, and/or guards etc.</li> <li>• PowerXL Series VFD supports the following physical access ports, <ul style="list-style-type: none"> <li>• RJ45 connector for removable keypad as well as Modbus RTU communications</li> <li>• RJ45 for EtherNet IP/Modbus TCP communications</li> <li>• Terminal block for Modbus RTU and other Digital IOs</li> </ul> </li> </ul> <p>Eaton suggests access to above physical ports need to be restricted.</p>



Category	Description
Restrict Logical access to PowerXL Series Drive	<p>It is extremely important to securely configure the logical access mechanisms provided in PowerXL Series VFD to safeguard the device from unauthorized access. PowerXL Series VFD provides various types of administrative, operational, configuration privilege levels. Eaton recommends that the available access control mechanisms be used properly to ensure that access to the system is restricted to legitimate users only. And, such users are restricted to only the privilege levels necessary to complete their job roles/functions.</p> <p>Eaton recommends below best practices to be followed to ensure adequate cybersecurity of the setup/system</p> <ul style="list-style-type: none"> <li>• Default credentials are changed upon first login. PowerXL Series VFD should not be commissioned for production with Default credentials, it's a serious Cybersecurity flaw as the default credentials are published in the manuals. Restrict administrative privileges - Threat actors are increasingly focused on gaining control of legitimate credentials, especially those associated with highly privileged accounts. Limit privileges to only those needed for a user's duties. Make sure that the password used in the device is only available to authorized users like Configuring Engineers and not shared among all operational users.</li> <li>• Perform periodic account maintenance to make sure that password is changed whenever there is personnel change.</li> <li>• Change passwords and other system access credentials as appropriate</li> <li>• PowerXL Series VFD is provided with data/access protection mechanism on keypad, follow below steps to utilize it</li> </ul> <p>PowerXL Series VFD provides four levels of data protection for users to ensure the security:</p> <ol style="list-style-type: none"> <li>1. Lock parameters on keypad. User can lock the parameters through DI or disable change, in which way all the parameters cannot be edited.</li> <li>2. Lock parameters while motor running. Motor control parameters can only be modified when motor is in stop mode. In which way to enhance the motor security. The parameters are listed in the application manual.</li> <li>3. Through Power Xpert inControl tool, facility to hide parameters on keypad is available. User can hide the parameters he/she thinks are significant for himself/herself. Such as IP address and so on.</li> <li>4. Password on keypad.             <ul style="list-style-type: none"> <li>• 0000 means no password, which is the default.</li> <li>• Password range is 0001 ~ 9999.</li> <li>• With password, user can monitor parameters value but need enter password if he/she wants to edit parameters.</li> <li>• User needs to re-enter the password if there is no key operation in 1 min after enter the password.</li> <li>• User needs to enter the old password if he/she wants to change to a new one.</li> </ul> </li> </ol>
Restrict Network Access	<p>PowerXL Series VFD provides network access to facilitate communication with other devices in the systems and configuration. But this capability could open up a big security hole if it's not configured securely.</p> <p>Eaton recommends segmentation of networks into logical enclaves and restrict the communication to host-to-host paths. This helps protect sensitive information and critical services and limits damage from network perimeter breaches. At a minimum, a utility Industrial Control Systems network should be segmented into a three-tiered architecture (as recommended by NIST SP800-82[R3]) for better security control.</p> <p>Deploy adequate network protection devices like Firewalls, Intrusion Detection / Protection devices,</p> <p>Below are the protocols and their port details available on PowerXL Series VFD. Use below information for configuring the firewalls.</p> <p>PowerXL Series VFD provides below communication protocols –</p> <ul style="list-style-type: none"> <li>• EtherNet IP protocols on RJ45 connector – enabled by default on port 44818 and 2222</li> <li>• Modbus TCP protocol on RJ45 connector – enabled by default on port 502</li> <li>• Modbus RTU on RS485 physical layer – enabled by default</li> <li>• BACnet MS/TP on RS485 physical layer – disabled by default, when this is enabled, Modbus RTU is disabled.</li> </ul> <p>All the protocols have dedicated menu structure, and details are described in User's Manual for how to activate or configure them.</p> <ul style="list-style-type: none"> <li>• Eaton has published detailed information about various Network level protection strategies in Eaton Cybersecurity Considerations for Electrical Distribution Systems [R1].</li> </ul>

## Appendix C—Recommended Secure Hardening Guidelines

Category	Description
Logging and Event Management	<p><b>Best Practices</b></p> <ul style="list-style-type: none"><li>• PowerXL Series VFD provides parameters change log and fault log functions for user, to help diagnose the drive</li></ul> <p>1. Parameters change log:</p> <ul style="list-style-type: none"><li>• PowerXL Series VFD will log the parameter information in FRAM when the parameter changes. The max number of 66 items can be logged. New log will rewrite the old one. User cannot clear this fault information.</li></ul> <p>2. Fault log:</p> <ul style="list-style-type: none"><li>• PowerXL Series VFD will log the drive information in FRAM when fault occurs. The max number of 10 items can be logged. New log will rewrite the old one. User can clear the history fault by pressing OK key more than 5 Sec.</li><li>• PowerXL Series VFD will log the fault information in FRAM when fault occurs. The max number of 50 items can be logged. New log will rewrite the old one. User cannot clear this fault information.</li></ul>
Secure Maintenance	<p><b>Best Practices</b></p> <p><b>Apply Firmware updates and patches regularly</b></p> <p>Due to rapidly increasing Cyber Threats in Industrial Control Systems, Eaton implements a comprehensive patch and update process for its products. Users are encouraged to maintain a consistent process to promptly monitor for fresh firmware updates and apply the update whenever required.</p> <ul style="list-style-type: none"><li>• The latest firmware can be acquired from the <a href="http://www.eaton.com/drives">www.eaton.com/drives</a> website. There will be separate link for PowerXL Series VFD FR0 to FR6 and PowerXL Series VFD FR7 &amp; FR8</li><li>• Users can also sign up on our website to get emails when new material is released to the site if desired.</li><li>• Using the PC Tool or verifying on the keypad the current version of firmware can be verified.</li><li>• For additional information or technical support on Eaton's Variable frequency drive products contact us at <a href="mailto:TRCDrives@eaton.com">TRCDrives@eaton.com</a> or by phone at 800-386-2273 for US customers. For European customers contact us at <a href="mailto:AfterSalesEGBonn@eaton.com">AfterSalesEGBonn@eaton.com</a> or by phone at +49 (0) 228602-3640</li></ul> <p>Eaton also has a robust vulnerability response process. In the event of any security vulnerability getting discovered in its products, Eaton patches the vulnerability and releases information bulletin through its cybersecurity website - <a href="http://www.eaton.com/cybersecurity">http://www.eaton.com/cybersecurity</a> and patches through <a href="http://www.eaton.com/drives">www.eaton.com/drives</a>.</p>

## References

[R1] Cybersecurity Considerations for Electrical Distribution Systems (WP152002EN):

[http://www.eaton.com/ecm/groups/public/@pub/@eaton/@corp/documents/content/pct\\_1603172.pdf](http://www.eaton.com/ecm/groups/public/@pub/@eaton/@corp/documents/content/pct_1603172.pdf)

[R2] Cybersecurity Best Practices Checklist Reminder (WP910003EN):

[http://www.cooperindustries.com/content/dam/public/powersystems/resources/library/1100\\_EAS/WP910003EN.pdf](http://www.cooperindustries.com/content/dam/public/powersystems/resources/library/1100_EAS/WP910003EN.pdf)

Notes:



**Eaton**  
1000 Eaton Boulevard  
Cleveland, OH 44122  
United States  
Eaton.com

© 2021 Eaton  
All Rights Reserved  
Printed in USA  
Publication No. MN040004EN/TBG001531  
September 2021

Eaton is a registered trademark.  
All trademarks are property  
of their respective owners.